



2020  
IOWA GREEN STREETS CRITERIA

*updated April 2023*

## ACKNOWLEDGMENTS

The Iowa Economic Development Authority thanks the following individuals and organizations for their assistance in improving and updating the Iowa Green Streets Criteria.

Kevin Nordmeyer  
BNIM

David Yocca  
Green Infrastructure/Living Systems Consultant

James Deeds  
KCL Engineering

Bill McAnally  
McAnally Consulting

The Iowa Economic Development Authority thanks Enterprise Community Partners for providing the Enterprise Green Communities Criteria as the foundation of the Iowa Green Streets Criteria. In addition, thank you to the U.S. Department of Energy, Building Science Corporation and Southface for being “go to” resources for quality building science-based research and resources.

# 2020 IOWA GREEN STREETS CRITERIA

## CONTENTS

- 1. INTEGRATIVE DESIGN 21**
  - 1.1 Integrative Design: Project Priorities Survey **22**
  - 1.2 Integrative Design: Charrettes and Coordination Meetings **24**
  - 1.3 Integrative Design: Documentation **27**
  - 1.4 Integrative Design: Construction Management **29**
  - 1.5 Design for Health and Well-Being: Health Action Plan **31**
  - 1.6 Resilient Communities: Multi-Hazard Risk/Vulnerability Assessment **39**
  - 1.7 Resilient Communities: Strengthening Cultural Resilience **42**
  - 1.8 Resilient Structures **45**
- 2. LOCATION + NEIGHBORHOOD FABRIC 46**
  - 2.1 Sensitive Site Protection **47**
  - 2.2 Connections to Existing Development and Infrastructure **51**
  - 2.3 Compact Development **53**
  - 2.4 Increased Compact Development **55**
  - 2.5 Proximity to Services and Community Resources **56**
  - 2.6 Preservation of and Access to Open Space for Rural/Tribal/Small Town **58**
  - 2.7 Preservation of and Access to Open Space **60**
  - 2.8 Access to Transit **61**
  - 2.9 Improving Connectivity to the Community **63**
  - 2.10 Passive Solar Heating/Cooling **66**
  - 2.11 Adaptive Reuse of Buildings **69**
  - 2.12 Access to Fresh, Local Foods **71**
  - 2.13 Advanced Certification: Site Planning, Design and Management **73**
  - 2.14 Local Economic Development and Community Wealth Creation **74**
  - 2.15a Access to Broadband: Broadband Ready **77**
  - 2.15b Access to Broadband: Connectivity **79**
- 3. SITE IMPROVEMENT 80**
  - 3.1 Environmental Remediation **81**
  - 3.2 Minimization of Disturbance during Staging and Construction **82**
  - 3.3 Ecosystem Services/Landscape **84**
  - 3.4 Surface Stormwater Management **87**
  - 3.5 Surface Stormwater Management Channel Protection Volume **89**
  - 3.6 Efficient Irrigation and Water Reuse **90**
  - 3.7 Efficient Irrigation and Water Reuse **92**

- 
- 4. WATER 93**
    - 4.1 Water-Conserving Fixtures **94**
    - 4.2 Advanced Water Conservation **96**
    - 4.3 Water Quality **97**
    - 4.4 Monitoring Water Consumption and Leaks **101**
    - 4.5 Efficient Plumbing Layout and Design **104**
    - 4.6 Non-Potable Water Reuse **106**
    - 4.7 Access to Potable Water During Emergencies **108**
  - 5. OPERATING ENERGY 110**
    - 5.1 Building Performance Requirements **111**
      - 5.1 a New Construction Building Performance Standard – Single Family And Multifamily **123**
      - 5.1 b Moderate And Substantial Rehab Building Performance Standard – Single Family And Multifamily **126**
      - 5.1 c New Construction Building Performance Standard – Commercial, Nonprofit, Mixed-Use **128**
      - 5.1 d Moderate And Substantial Rehab Building Performance Standard – Commercial, Nonprofit, Mixed-Use **130**
    - 5.2 a Moving to Zero Energy: Additional Reductions in Energy Use **132**
    - 5.2 b Moving to Zero Energy: Near Zero Certification **134**
    - 5.3 a Moving to Zero Energy: Photovoltaic/Solar Hot Water Ready **136**
    - 5.3 b Moving to Zero Energy: Renewable Energy **138**
    - 5.4 Achieving Zero Energy **140**
    - 5.5 a Moving to Zero Carbon: All-Electric Ready **142**
    - 5.5 b Moving to Zero Carbon: All Electric **144**
    - 5.6 Sizing of Heating and Cooling Equipment **146**
    - 5.7 ENERGY STAR Appliances **148**
    - 5.8 Lighting **149**
    - 5.9 Resilient Energy Systems: Floodproofing **151**
    - 5.10 Resilient Energy Systems: Critical Loads **153**
    - 5.11 Electric Vehicle Charging **155**
    - 5.12 Advanced Framing **156**
    - 5.13 FORTIFIED Roofs and Homes **161**
  - 6. MATERIALS 162**
    - 6.1 Ingredient Transparency for Material Health **163**
    - 6.2 Recycled Content and Ingredient Transparency **165**
    - 6.3 Chemical Hazard Optimization **167**
    - 6.4 Healthier Material Selection **169**
    - 6.5 Environmentally Responsible Material Selection **175**
    - 6.6 Bath, Kitchen, Laundry Surfaces **178**
    - 6.7 Regional Materials **179**
    - 6.8 Managing Moisture: Foundations **180**
    - 6.9 Managing Moisture: Roofing and Wall Systems **182**
    - 6.10 Construction Waste Management **185**
    - 6.11 Recycling Storage **188**

- 
- 7. HEALTHY LIVING ENVIRONMENT 190**
    - 7.1 Radon Mitigation **191**
    - 7.2 Reduce Lead Hazards in Pre-1978 Buildings **194**
    - 7.3 Combustion Equipment **195**
    - 7.4 Garage Isolation **197**
    - 7.5 Integrated Pest Management **198**
    - 7.6 Smoke-Free Policy **200**
    - 7.7 Ventilation **203**
    - 7.8 Dehumidification **206**
    - 7.9 Construction Pollution Management **208**
    - 7.10 Noise Reduction **209**
    - 7.11 Active Design: Promoting Physical Activity **212**
    - 7.12 Beyond ADA: Universal Design **215**
    - 7.13 Healing-Centered Design **217**
  - 8. OPERATIONS, MAINTENANCE + OCCUPANT ENGAGEMENT 221**
    - 8.1 Building Operations & Maintenance Manual and Plan **222**
    - 8.2 Emergency Management Manual **226**
    - 8.3 Occupant Manual **228**
    - 8.4 Walk-Throughs and Orientations to Property Operation **231**
    - 8.5 Energy and Water Data Collection and Monitoring **233**

## Appendices

- Appendix A: Green Development Plan and Checklist
- Appendix B: Certification of Intent to Comply
- Appendix C: Certification of Construction Document Compliance
- Appendix D: Certification of Compliance at End of Construction
- Appendix E: Energy Performance Certification
- Appendix F: Project Plan and Spec Book Checklist
- Appendix G: Air Sealing Details
- Appendix H Integrated Design Agenda and Outcomes Template
- Appendix I: Stormwater Management Milestone Checklist
- Appendix J: Construction Typology Definitions
- Appendix K: Project Priorities Survey
- Appendix L: SCAQMD Tables for use with Criterion 6.4
- Appendix M: Universal Design Checklist
- Appendix N: Glossary

---

## INTRODUCTION

The Iowa Green Streets Criteria promote public health, energy efficiency, water conservation, smart locations, operational savings, and sustainable building practices. The strategies in the following pages enhance affordable housing, community facilities, town centers and whole communities.

Since 2008, the Iowa Green Streets Criteria has influenced the performance of thousands of residences and numerous community facility and Main Street projects across Iowa. This edition of the Iowa Green Streets Criteria builds on lessons learned by the Iowa Economic Development Authority, Enterprise Green Communities and from the growing body of building science research and demonstration projects.

## NEW TO THIS DOCUMENT

Much of the Iowa Green Streets Criteria in previous versions remains unchanged or has undergone minor changes. A complete reading of the full Iowa Green Streets Criteria should be completed as a reminder of previously existing criteria and to identify new criteria. Some of the more significant changes to the criteria worth extra noting include the following.

- Project Priority Survey, Documentation and Construction Management (Section 1): Additional criteria and greater emphasis has been added on the use of project priority surveys, integrated design, and construction management. Supporting those areas of emphasis are new requirements for incorporating Iowa Green Streets Criteria into formal project specifications.
- Safe Room (Section 1): Depending on the project type, installation of a safe room has been added as a requirement or option.
- Broadband (Section 2): Preparing for and providing access to Broadband service has been added as Baseline and optional criteria respectively.
- Irrigation (Section 4): The prohibition on irrigation has been modified to allow for irrigation utilizing harvested, non-potable water sources.
- Water Quality and Supply (Section 4): A criterion has been added to address water quality issues created by lead service lines as well as other potential pollutants in project water supplies. Also new is a criterion addressing the need for potable water during emergencies.
- Zero Energy and Zero Carbon (Section 5): Several criteria in section 5 have been updated to reflect changing energy codes and the national growth in zero energy projects and decarbonization of the economy.
- Healthier Materials (Section 6): The Iowa Green Streets Criteria mirrors the Green Communities Criteria by adding criterion focused on product ingredient transparency, recycled content, regional manufacturing, and chemical hazard optimization.
- Universal and Healing-Centered Design (Section 7): A Baseline and optional level of universal design is offered with a new universal design required best practices checklist. Also added is an optional criterion focused on healing-centered design.

## HOW TO USE THIS DOCUMENT

The Baseline criteria referenced in this document are based on the national 2020 Green Communities Criteria. Any revisions to the national Green Communities Criteria will not apply to Iowa Economic Development Authority projects unless adopted by the Iowa Economic Development Authority and specifically addressed in the Iowa Green Streets Criteria.

Enterprise's Green Communities Criteria is applied solely to residential projects while the Iowa Green Streets Criteria may be applied to residential, commercial, nonprofit, mixed-use, and public facility projects (also commercial). Therefore, throughout the manual the terms residential, tenant, occupant, project user and building user are used interchangeably in an attempt to apply the criteria in a manner that makes the most sense for the type of project being undertaken.

All Baseline Iowa Green Streets Criteria are required for both residential and non-residential applications. However, there are certain criteria that are not applicable to or are different for non-residential applications. Therefore, certain criterion include different requirements for residential versus non-residential projects.

Each of the Iowa Green Streets Criteria starts with a **Rationale** that describes the intended impact and value of implementing the strategy described. That's followed by a **Requirement** section that shares how an affordable housing team should go about achieving the intent of the criterion. Next, there's a **Recommendations** section, which offers suggestions that go above and beyond the Requirements, for teams that are interested in pursuing the criterion deeply. Finally, each criterion includes a **Resources** section, with links to information that may be of use to teams as they consider and implement each strategy.

This Iowa Green Streets Criteria document is subject to periodic revision and update. Refer to [iowaeda.com/green-streets](http://iowaeda.com/green-streets) for updates.

## ACTIVITIES AND PROJECTS COVERED BY THE IOWA GREEN STREETS CRITERIA

Projects receiving funding from these IEDA programs are required to follow the Iowa Green Streets Criteria.

- Community Development Block Grant Program Community Facilities
- Community Development Block Grant Program Sustainable Community Demonstration
- Community Development Block Grant Program Disaster Recovery (selected projects)
- Main Street Iowa Challenge Grant
- Community Catalyst Remediation Grant
- Multifamily new construction
- Multifamily substantial rehabilitation (see Definition of Rehabs below)
- Multifamily moderate rehabilitation (see Definition of Rehabs below)
- Single-family new construction

## IOWA GREEN STREETS CRITERIA CATEGORIES

The 2020 Iowa Green Streets Criteria are grouped into the following eight categories:

1. Integrative Design
2. Location + Neighborhood Fabric
3. Site Improvement
4. Water
5. Operating Energy
6. Materials
7. Healthy Living Environment
8. Operations, Maintenance, and Occupant Engagement

---

## WHY USE THE CRITERIA?

Consider this: 70% of design decisions are made in the first 10% of a project. To maximize time and resources, planning ahead is essential. First, project teams should familiarize themselves with the full Criteria. Then, using a thorough integrative design process, they should consider the goals for the project — and goals for the future residents and occupants — when evaluating which criteria to incorporate into their building(s). Taking a human-centered approach to design and development will lead to a comprehensive planning process and a careful selection of materials and technologies that will better meet project aspirations.

In addition to increasing resource efficiency and reducing environmental impacts, green building strategies can yield cost savings through long-term reduction in operating expenses. The benefits include improved energy performance and comfort, a healthier indoor environment, increased durability of building components, and simplified maintenance requirements that can lead to financial efficiencies for property managers and owners. Green building practices improve the economics of managing affordable housing, community facilities, and Main Street businesses while enhancing quality of life for residents, visitors and employees. When green building practices inform the location of our buildings — placing homes, community facilities and businesses near community amenities such as public transportation to create walkable, livable neighborhoods — the benefits for citizens and communities expand to include fewer sprawl-related transportation impacts.

Guiding principles behind the Iowa Green Streets Criteria ensure that buildings must be cost effective to build, and durable and practical to maintain. In addition, the principles work together to help produce green buildings that:

- Result in a high-quality, healthy living and working environment
- Lower utility costs
- Enhance connections to nature
- Protect the environment by conserving energy, water, materials, and other resources
- Advance the health of local and regional ecosystems

Some criterion may not have directly measurable financial impacts, but these criteria are no less important to meeting a project's mission. Projects will exhibit improved occupant health and well-being through reduced exposure to environmental pollutants, improved connectivity to services and walkable neighborhoods, and good lighting. The benefits extend beyond the occupants to the neighboring community by supporting local community services and activating neighborhood streets, as well as improving water quality and reducing the impact of stormwater run-off on neighboring sewer systems. We suspect that when these benefits are quantified, they will dwarf the energy and water savings benefits we can count today.

Enterprise's project pipeline includes projects that avoid upfront cost premiums when meeting the Enterprise Green Communities Criteria as compared to standard practice after implementing a robust integrative design approach. And overall, the median incremental cost of complying with the Enterprise Green Communities Criteria tends to be minimal. In an evaluation report, Enterprise found a median 2% increase to total development cost. The average project analyzed in this study achieved lifetime utility savings that exceed the cost of integrating the Enterprise Green Communities Criteria, with a simple payback of 5.59 years.



---

## DEFINITION OF REHABS

Given that the scope of work on existing buildings can vary widely. We have defined two levels of rehabs, to guide project team planning.

Substantial Rehab is defined as a project where the work area exceeds 50% of the aggregate area of the building: an International Code Council (ICC) level 3 alteration scope of work.

Moderate Rehab is defined as a project where the work area does not exceed 50% of the aggregate area of the building (the work scope is less than an ICC level 3 alteration), yet is still able to comply with the applicable energy performance requirements of Criteria 5.1-5.1d.

While Substantial and Moderate Rehabs are defined as specifically as possible above, each project will most likely have more nuance than can be captured here. Please use these definitions as the start of this guidance, strive for the most inclusive level of integrating the Criteria, and note that compliance with the energy performance requirements of Criterion 5.1 often is the factor that places a project in the New Construction pathway, Substantial Rehab pathway or Moderate Rehab pathway. If you are unsure whether your project qualifies as a substantial or moderate rehab project, please contact the IEDA prior to program application at [greenstreets@iowaeda.com](mailto:greenstreets@iowaeda.com).

## OPTIONAL POINTS AND IOWA GREEN STREETS CERTIFICATION PLUS

Two levels of certification are available: Iowa Green Streets Certification and Iowa Green Streets Certification Plus. The new “Plus” level recognizes significant achievement for projects that meet all Baseline requirements and have invested in deeper levels of energy efficiency, water conservation, and stormwater management while supporting regional economies.

To achieve Iowa Green Streets Criteria Certification, all projects must achieve compliance with the Baseline criteria measures applicable to that project type. **Additionally, New Construction projects must achieve at least 40 optional points, Substantial Rehab and Moderate Rehab projects must achieve at least 35 optional points.** Projects proposing to achieve a higher quantity of optional points may be scored more favorably during the application review process.

Projects that also comply with additional criteria 3.5, 4.2, 5.2b or 5.4, and 6.7 will be recognized with Iowa Green Streets Certification Plus. See individual criterion for more details.

## ATTRIBUTION

To assist project teams in meeting the Iowa Green Streets Criteria performance expectations, many recommendations and resources are provided by IEDA and Enterprise including links to online resources and images of high performance building best practices. Information published by the Building Science Corporation (BSC) on [buildingscience.com](http://buildingscience.com) is protected by copyright under U.S. and International copyright laws and conventions. See [buildingscience.com/editorial-policies-conditions-use](http://buildingscience.com/editorial-policies-conditions-use) for additional information.

## IOWA GREEN STREETS CRITERIA STEP-BY-STEP PROCESS FOR DISASTER RECOVERY HOUSING PROJECTS

The Iowa Green Streets Criteria verification process is primarily self-driven, with third-party assistance and verification at key points in the design and construction process. Listed below are the REQUIRED key quality assurance and verification process steps to implementing the Iowa Green Streets Criteria.

**NOTE:** Depending on your project, some of the steps may take place in another order or simultaneously. Please refer to the full Iowa Green Streets Criteria for more details.

### **APPLICATION PHASE**

- Step 1** Read the [Iowa Green Streets Criteria](#).
- Step 2** Notify [IEDA](#) that you are planning a project following Iowa Green Streets Criteria.
- Step 3** Participate in design consultation with IEDA. If known, include architect, contractors, engineers, and site supervisor.
- Step 4** Conduct integrated design process (Criteria 1.1 – 1.3). Address all baseline and selected optional Green Streets criteria.
- Step 5** Complete [Appendix A](#), Disaster-Recovery Project Green Development Plan and Checklist. Select at least 40 points of optional criteria (35 points for rehab projects) project commits to completing. All selected optional points become required.
- Step 6** Provide completed Appendices A and B to grant administrator to upload with project application to [iowagrants.gov](#).

### **AFTER GRANT AWARD, PRIOR TO RELEASE OF FUNDS/ENVIRONMENTAL REVIEW APPROVAL**

- Step 7** Upon award, project team, including Home Energy Rating System (HERS) rater, meets to complete HERS preliminary modeling to verify project design meets Green Streets Criteria energy goals (Criteria 5.1-5.1d).
- Step 8** Engage HVAC designer to complete ACCA Manual S, J, and D.
- Step 9** Contact [Iowa Department of Agriculture and Land Stewardship](#) (IDALS) for stormwater technical assistance at 30%, 60%, 90%, and final design (Criteria 3.4 - 3.5). Have IDALS sign Appendix I, Stormwater Management Milestone Checklist, indicating project's 90% design adheres to Green Streets Criteria and Iowa Stormwater Manual.

### **AFTER RELEASE OF FUNDS/ENVIRONMENTAL REVIEW APPROVAL**

- Step 10** Register project on Iowa Department of Public Safety (DPS) [ImageTrend](#) system. Take screen shot verifying that project has been registered.
- Step 11** Have project design approved by DPS. (Single-Family (1-4 units) Projects Excluded)
- Step 12** **PRIOR TO BIDDING**, complete [Appendix F](#), Project Plan and Spec Book Checklist. Appendix F is a tool for the project team to confirm all required and selected optional Green Streets Criteria are included in project plans and specs.
- Step 13** **PRIOR TO BIDDING**, provide to your grant administrator to upload to [iowagrants](#) Green Streets Criteria section
  - Signed Green Streets Criteria Appendices C and I;
  - Preliminary energy report from the HERS Rater; and
  - Screen shot of DPS ImageTrends system registration (single-family projects) OR project design approval from DPS (multifamily and commercial projects).
- Step 14** Conduct contractor and sub-contractor pre-construction meeting to review Green Streets Criteria.
- Step 15** Submit photos of key construction steps installed to [greenstreets@iowaeda.com](mailto:greenstreets@iowaeda.com) (Criteria 5.1a-5.1d)
- Step 16** **PRIOR TO DRYWALL INSTALLATION**, have HERS Rater or commissioning agent (commercial projects only) conduct thermal bypass inspection (Criterion 5.1).
- Step 17** Have HERS Rater complete system testing (Criteria 5.1-5.1d).
- Step 18** Grant administrator uploads signed Appendices [D](#) and [E](#) to [iowagrants](#) Green Streets Criteria section.



## 2020 IOWA GREEN STREETS CRITERIA QUICK REFERENCE

This checklist provides an overview of the technical requirements within the Iowa Green Street Criteria.

To achieve Iowa Green Streets Criteria Certification, all projects must achieve compliance with the Criteria Baseline measures applicable to that project type. Additionally, New Construction projects must achieve 40 optional points, Substantial Rehab projects must achieve 35 optional points, and Moderate Rehab projects must also achieve 35 optional points.

Projects proposing to achieve a higher quantity of optional points may be scored more favorably during the application review process. To assist you in evaluating your project, a fillable form is available here:

[iowaeda.com/userdocs/programs/2020iowagreenstreetscriteriachecklistform.pdf](http://iowaeda.com/userdocs/programs/2020iowagreenstreetscriteriachecklistform.pdf)

<b>B = Baseline</b> <b># = OPTIONAL POINTS</b>		
<b>1. INTEGRATIVE DESIGN</b>		
<input type="radio"/> YES <input type="radio"/> NO <input type="radio"/> MAYBE	<b>B</b>	<b>1.1 Integrative Design: Project Priorities Survey</b> Complete the Project Priorities Survey in Appendix K.
<input type="radio"/> YES <input type="radio"/> NO <input type="radio"/> MAYBE	<b>B</b>	<b>1.2 Integrative Design: Charrettes and Coordination Meetings</b> Develop an integrative design process that moves the outputs of the Project Priorities Survey into action through a series of collaborative meetings. Prioritize multi-benefit strategies. Assign responsibility within your design and development teams for accountability.
<input type="radio"/> YES <input type="radio"/> NO <input type="radio"/> MAYBE	<b>B</b>	<b>1.3 Integrative Design: Documentation</b> Include Iowa Green Streets Criteria information in your contract documents and construction specifications (Division 1 Section 01 81 13 Sustainable Design Requirements) as necessary for the construction team to understand the requirements and how they will be verified. Ensure, and indicate that the drawings and specifications have been generated to be compliant and meet the certification goals.
<input type="radio"/> YES <input type="radio"/> NO <input type="radio"/> MAYBE	<b>B</b>	<b>1.4 Integrative Design: Construction Management</b> Create, implement, and document your contractor/subcontractor education plan to ensure that all persons working on-site fully understand their role in achieving the project objectives. Include a summary of the Project Priorities Survey (Criterion 1.1), the sustainability goals, and anticipated roles of each party regarding performance expected of the project. Attach and reference this training plan to Division 1 Section 01 81 13 Sustainable Design Requirements. Include timeline estimates for performance testing and verification schedules in the overall construction schedule. As relevant, review requirements for Criteria 8.1, 8.2, and 8.3, and begin populating these documents with relevant information from design and construction.
<input type="radio"/> YES <input type="radio"/> NO <input type="radio"/> MAYBE	<b>12 or 15</b>	<b>1.5 Design for Health and Well-Being: Health Action Plan</b> Follow Steps 1–6 of the Health Action Plan framework per the full criterion. [12 points with extra 3 points for Step 7] This includes: 1) Commit to embedding health into the project lifecycle; 2) Partner with a project health professional; 3) Collect and analyze community health data; 4) Engage with community stakeholders to prioritize health data and strategies; 5) Identify strategies to address those health issues; 6) Create an implementation plan; and 7) Create a monitoring plan.





B = Baseline # = OPTIONAL POINTS		
<input type="radio"/> YES <input type="radio"/> NO <input type="radio"/> MAYBE	<b>B</b>	<b>2.2 Connections to Existing Development and Infrastructure</b> Locate the project on a site with access to existing roads, water, sewers, and other infrastructure and within or contiguous to (having at least 25% of the perimeter bordering) existing development. Connect the project to the existing pedestrian network. For sites over 5 acres, provide connections to the adjacent street network at least every 800 feet. Tie all planned bike paths to existing bike paths.
<input type="radio"/> YES <input type="radio"/> NO <input type="radio"/> MAYBE	<b>B</b>	<b>2.3 Compact Development</b> ( <i>Baseline for New Construction</i> ) At a minimum, build to the residential density (dwelling units/acre) of the census block group where the project is located. In Rural/Tribal/Small Town locations that do not have zoning requirements: Build to a minimum net density of 5 units per acre for single-family houses; 10 units per acre for multifamily buildings, single and two-story; and 15 units per acre for multifamily buildings greater than two-stories.
<input type="radio"/> YES <input type="radio"/> NO <input type="radio"/> MAYBE	<b>5 or 7</b>	<b>2.4 Compact Development</b> Exceed the residential density (dwelling units/acre) of the census block group in which your project is located. Exceed by 2x for [5 points]; exceed by 3x for [7 points]. In Rural/Tribal/Small Towns that do not have zoning requirements, build to a minimum net density of 7.5 units per acre for single-family houses; 12 units per acre for multifamily buildings, single and two-story; and 20 units per acre for multifamily buildings greater than two stories. [5 points]
<input type="radio"/> YES <input type="radio"/> NO <input type="radio"/> MAYBE	<b>B</b>	<b>2.5 Proximity to Services and Community Resources</b> ( <i>Baseline for New Construction</i> ) Locate the project within a 0.5-mile walk distance of at least four, or a 1-mile walk distance of at least seven, of the listed services.
<input type="radio"/> YES <input type="radio"/> NO <input type="radio"/> MAYBE	<b>B</b>	<b>2.6 Preservation of and Access to Open Space for Rural/Tribal/Small Town</b> <i>(Baseline for New Construction Rural/Tribal/Small Town)</i> <b>Option 1:</b> Locate the project within a 0.25-mile walk distance of dedicated public open space that is a minimum of 0.75 acres; at least 80% of which unpaved. OR <b>Option 2:</b> Set aside a minimum of 10% (minimum of 0.25 acres) of the total project acreage as open and accessible to all residents; at least 80% of which unpaved.
<input type="radio"/> YES <input type="radio"/> NO <input type="radio"/> MAYBE	<b>6 Max</b>	<b>2.7 Preservation of and Access to Open Space</b> <b>Option 1:</b> Locate the project within a 0.25-mile walk distance of dedicated open space that is a minimum of 0.75 acres; at least 80% of which unpaved. OR <b>Option 2:</b> Set aside a percentage of permanent open space for use by all residents; at least 80% of which unpaved. 20% [2 points]; 35% [4 points]; 45% + written statement of preservation/conservation policy [6 points].



<input type="radio"/> YES <input type="radio"/> NO <input type="radio"/> MAYBE		B = Baseline # = OPTIONAL POINTS		
<input type="radio"/> YES <input type="radio"/> NO <input type="radio"/> MAYBE		3  2  2	<b>2.8 Access to Transit</b>  Fixed route bus service available within .5 (1/2) mile walking distance of the property in which the bus stops at least twenty (20) times per weekday. <i>[3 points]</i>  Fixed route bus service available withing .5 (1/2 mile) walking distance of the property in which the bus stops at least ten (10) times per weekday. <i>[2 points]</i>  Rides are scheduled for pick up at your door or by the curb from their residence to a location of choice. <i>[2 points]</i>	
<input type="radio"/> YES <input type="radio"/> NO <input type="radio"/> MAYBE			2-8	<b>2.9 Improving Connectivity to the Community</b> Improve access to community amenities through at least one of the options incentivizing biking mobility or improving access to transit.
<input type="radio"/> YES <input type="radio"/> NO <input type="radio"/> MAYBE			5 Max	<b>2.10 Passive Solar Heating/Cooling</b> Design and build with passive solar design, orientation, and shading that meet the guidelines specified.
<input type="radio"/> YES <input type="radio"/> NO <input type="radio"/> MAYBE		10	<b>2.11 Adaptive Reuse of Buildings</b> Rehabilitate and adapt an existing structure. Design the project to adapt, renovate, or reuse at least 50% of the existing structure and envelope.	
<input type="radio"/> YES <input type="radio"/> NO <input type="radio"/> MAYBE		6	<b>2.12 Access to Fresh, Local Foods</b> Provide residents and staff with access to fresh, local foods through one of the following options: <b>Option 1:</b> Neighborhood Farms and Gardens <b>Option 2:</b> Community-Supported Agriculture <b>Option 3:</b> Proximity to Farmers Market	
<input type="radio"/> YES <input type="radio"/> NO <input type="radio"/> MAYBE		8	<b>2.13 Advanced Certification: Site Planning, Design, and Management</b> Locate building(s) within a community that is certified in LEED for Neighborhood Development, LEED for Cities and Communities, Living Community Challenge, or SITES.	
<input type="radio"/> YES <input type="radio"/> NO <input type="radio"/> MAYBE		B = Baseline # = OPTIONAL POINTS		
<input type="radio"/> YES <input type="radio"/> NO <input type="radio"/> MAYBE		2  3  3	<b>2.14 Local Economic Development and Community Wealth Creation</b> Demonstrate that local preference for construction employment and subcontractor hiring was part of your bidding process, and how it functioned during construction. <b>OR</b> Demonstrate that you achieved at least 20% local employment. <b>OR</b> Provide physical space for small business, nonprofits, and/or skills and workforce education.	



<input type="radio"/> YES <input type="radio"/> NO <input type="radio"/> MAYBE	<b>B</b>	<b>2.15a Access to Broadband: Broadband Ready</b> <i>(Baseline for New Construction and Substantial Rehab Projects in Rural/Tribal/Small Town Locations)</i> Incorporate broadband infrastructure so that when broadband service comes to a community, the property can be easily connected. Include a network of mini-ducts or conduit throughout the building, extending from the expected communications access point to each network termination point in the building.
<input type="radio"/> YES <input type="radio"/> NO <input type="radio"/> MAYBE	<b>6</b>	<b>2.15b Access to Broadband: Connectivity</b> <i>(Optional for Rural/Tribal/Small Town)</i> Ensure all units and common spaces in the property have broadband internet access with at least a speed of 25/3 mbs.
		SUBTOTAL OPTIONAL POINTS
<b>B</b> = Baseline <b>#</b> = OPTIONAL POINTS		
<b>3. SITE IMPROVEMENTS</b>		
<input type="radio"/> YES <input type="radio"/> NO <input type="radio"/> MAYBE	<b>B</b>	<b>3.1 Environmental Remediation</b> Determine whether there are any hazardous materials present on the site through one of the four methods listed. Mitigate any contaminants found.
<input type="radio"/> YES <input type="radio"/> NO <input type="radio"/> MAYBE	<b>B</b>	<b>3.2 Minimization of Disturbance During Staging and Construction</b> For sites >1 acre, implement EPA's National Pollutant Discharge Elimination System Stormwater Discharges from Construction Activities guidance, or local requirements, whichever is more stringent. For sites with an area ≤1, follow guidance in full criterion.
<input type="radio"/> YES <input type="radio"/> NO <input type="radio"/> MAYBE	<b>B</b>	<b>3.3 Ecosystem Services/Landscape</b> <i>(Baseline, if providing landscaping)</i> If providing plantings, all must be native or climate-appropriate (adapted) to the region and appropriate to the site's soil and microclimate. Do not introduce any invasive plant species. Plant, seed, or xeriscape all disturbed areas.
<input type="radio"/> YES <input type="radio"/> NO <input type="radio"/> MAYBE	<b>B</b>	<b>3.4 Surface Stormwater Management</b> <i>(Baseline for New Construction; Baseline for all Rehab projects if land disturbed is ≥1,000 sq.ft.)</i> Through on-site infiltration, evapotranspiration, and rainwater harvesting, retain the 1.25" rain event on site.
<b>B</b> = Baseline <b>#</b> = OPTIONAL POINTS		
<input type="radio"/> YES <input type="radio"/> NO <input type="radio"/> MAYBE	<b>10</b>	<b>3.5 Surface Stormwater Management: Channel Protection Volume</b> <i>(Baseline to manage 2.5" rain event for Iowa Green Streets Certification Plus)</i> Through on-site infiltration, evapotranspiration, and rainwater harvesting, retain the 1.25" rain event on site (rehab projects) or 2.5" rain event on site (new construction or projects disturbing ≥ 1,000 square feet).



<input type="radio"/> YES <input type="radio"/> NO <input type="radio"/> MAYBE	<b>B</b>	<b>3.6 Efficient Irrigation and Water Reuse</b> <i>(Baseline, if permanent irrigation is utilized)</i> At least 50% of the site's irrigation satisfied by water use from the sources listed. If irrigation is utilized, install an efficient irrigation system per the requirements listed.
<input type="radio"/> YES <input type="radio"/> NO <input type="radio"/> MAYBE	<b>6</b>	<b>3.7 Efficient Irrigation and Water Reuse</b> <i>(for systems grandfathered-in in 3.6)</i> At least 50% of the site's irrigation satisfied by water use from the sources listed.
		SUBTOTAL OPTIONAL POINTS
<b>B</b> = Baseline <b>#</b> = OPTIONAL POINTS		
<b>4. WATER CONSERVATION</b>		
<input type="radio"/> YES <input type="radio"/> NO <input type="radio"/> MAYBE	<b>B</b>	<b>4.1 Water-Conserving Fixtures</b> Install water-conserving fixtures meeting the specifications in the criterion. For all single-family homes and all dwelling units in buildings three stories or fewer, the static service pressure must not exceed 60 psi.
<input type="radio"/> YES <input type="radio"/> NO <input type="radio"/> MAYBE	<b>6 Max</b>	<b>4.2 Advanced Water Conservation</b> <i>[Baseline for Iowa Green Streets Certification Plus]</i> Reduce total indoor water consumption by at least 30% compared to baseline indoor water consumption chart. Any new toilet, showerhead, and/or lavatory faucet must be WaterSense certified.
<input type="radio"/> YES <input type="radio"/> NO <input type="radio"/> MAYBE	<b>B / 3</b>  <b>B</b>  <b>8</b>	<b>4.3 Water Quality</b> <b>Baseline/Optional:</b> Baseline for Substantial Rehabs of buildings built before 1986; Optional for all other building types: Replace lead service lines. <i>[3 points]</i>  <b>Baseline:</b> For multifamily buildings with either a cooling tower, a centralized hot water system, or 10+ stories: Develop a Legionella water management program.  <b>Optional:</b> Test and remediate as indicated for lead, nitrates, arsenic, and coliform bacteria.
<b>B</b> = Baseline <b>#</b> = OPTIONAL POINTS		





<input type="radio"/> YES <input type="radio"/> NO <input type="radio"/> MAYBE	<b>4</b>	<p><b>4.4 Monitoring Water Consumption and Leaks</b>                      Conduct pressure-loss tests and visual inspections to determine if there are leaks; fix leaks.  <b>AND</b>                      Install an advanced water monitoring and leak detection system capable of identifying and shutting water off during anomalous water events.  <b>OR</b>                      Install a device to separately monitor water consumption of each cold branch off the apartment line riser for each dwelling unit or each cold water riser and the domestic hot water cold water feed for each building or each toilet that allows remote monitor readings; common laundry facilities; boiler makeup water; outdoor water consumption; and water consumption in any non- residential space.</p>
<input type="radio"/> YES <input type="radio"/> NO <input type="radio"/> MAYBE	<b>4</b>	<p><b>4.5 Efficient Plumbing Layout and Design</b>                      Store no more than 0.5 gallon of water in any piping/manifold between the fixture and the water heating source or recirculation line. No more than 0.6 gallon of water shall be collected from the fixture before a 10-degree Fahrenheit rise in temperature is observed. Recirculation systems must be demand-initiated.</p>
<input type="radio"/> YES <input type="radio"/> NO <input type="radio"/> MAYBE	<b>6 Max</b>	<p><b>4.6 Non-Potable Water Reuse</b>                      Harvest, treat, and reuse rainwater and/or greywater to meet a portion of the project's non-potable water needs: 10% reuse [3 points]; 20% reuse [4 points]; 30% reuse [5 points]; 40% reuse [6 points].</p>
<input type="radio"/> YES <input type="radio"/> NO <input type="radio"/> MAYBE	<b>8</b>	<p><b>4.7 Access to Potable Water During Emergencies</b>                      Provide residents with ready access to potable water in the event of an emergency that disrupts normal access to potable water, including disruptions related to power outages that prevent pumping water to upper floors of multifamily buildings or pumping of water from on-site wells, per one of the three options listed.</p>
		SUBTOTAL OPTIONAL POINTS
<p><b>B</b> = Baseline  <b>#</b> = OPTIONAL POINTS</p>		
<b>5. OPERATING EFFICIENCY</b>		
<input type="radio"/> YES <input type="radio"/> NO <input type="radio"/> MAYBE	<b>B</b>	<p><b>5.1 Building Performance Requirements</b>                      Follow the Air Barrier and Insulation Inspection Component Guide and Energy Performance Table for measures applicable to your project.</p>
<input type="radio"/> YES <input type="radio"/> NO <input type="radio"/> MAYBE	<b>B</b>	<p><b>5.1a Building Performance Standard</b>                      (New Construction: single-family and low-rise multifamily)                      Certify dwelling units in the project meet or exceed the Energy Performance Requirements in Criterion 5.1 or certify the project through the ENERGY STAR New Homes program.</p>
<input type="radio"/> YES <input type="radio"/> NO <input type="radio"/> MAYBE	<b>B</b>	<p><b>5.1b Building Performance Standard</b>                      (Substantial and Moderate Rehab: Single Family and Multifamily)                      Certify dwelling units in the project meet or exceed the Energy Performance Requirements in Criterion 5.1 and the air infiltration, insulation, and HVAC performance guidelines in the criterion.</p>
<p><b>B</b> = Baseline  <b>#</b> = OPTIONAL POINTS</p>		



<input type="radio"/> YES <input type="radio"/> NO <input type="radio"/> MAYBE	<b>B</b>	<b>5.1c Building Performance Standard</b> (New Construction: Commercial, Nonprofit and Mixed-Use) Follow all applicable requirements and best practices in Criterion 5.1. Projects must exceed the performance of the current state of Iowa adopted Energy Code at the time of submittal for plan review by at least 10 percent. Commission the building.
<input type="radio"/> YES <input type="radio"/> NO <input type="radio"/> MAYBE	<b>B</b>	<b>5.1d Building Performance Standard</b> (Substantial and Moderate Rehab: Commercial, Nonprofit and Mixed-Use) Follow all applicable requirements and best practices in Criterion 5.1. Substantial rehab projects must exceed the performance of the current state of Iowa adopted Energy Code at the time of submittal for plan review by at least 10 percent. Moderate rehab projects must meet or exceed the current state of Iowa adopted Energy Code at the time of submittal for plan review. Commission the building.
<input type="radio"/> YES <input type="radio"/> NO <input type="radio"/> MAYBE	<b>12 Max</b>	<b>5.2a Moving to Zero Energy: Additional Reductions in Energy Use</b> <i>[Baseline for Disaster Recovery Housing Projects to Achieve ≥5 points]</i> (Not available for projects using prescriptive path for Criterion 5.1a or for projects following Criterion 5.2b or 5.4.) Design and construct a building that is projected to be more efficient than what is required by Criteria 5.1a-5.1d. Achieve HERS score of 5 points lower than required by 5.1a-5.1d OR 5% greater efficiency than required if following ASHRAE path for 5.1a-5.1d compliance <i>[5 points]</i> .  Additional 1 point for each additional 2-point decrease in HERS score required by Criteria 5.1a-5.1d OR for 1% greater efficiency if following ASHRAE path for Criteria 5.1a-5.1d, up to a maximum of 12 optional points.
<input type="radio"/> YES <input type="radio"/> NO <input type="radio"/> MAYBE	<b>12-15</b>	<b>5.2b Moving to Zero Energy: Near Zero Certification</b> <i>[5.2b or 5.4 Baseline for Iowa Green Streets Certification Plus]</i> (Not available for projects following Criterion 5.2a or 5.4.)  Certify the project in a program that requires advanced levels of building envelope performance such as DOE ZERH <i>[12 points]</i> and/or PHI Classic or PHIUS+ <i>[15 points]</i> .
<input type="radio"/> YES <input type="radio"/> NO <input type="radio"/> MAYBE	<b>3-6</b>	<b>5.3a Moving to Zero Energy: Photovoltaic/Solar Hot Water Ready</b> <i>[Baseline for Disaster Recovery Housing Projects]</i> (Not available for projects following Criterion 5.3b or 5.4.) Orient, design, engineer, wire, and/or plumb the development through the Photovoltaic Ready pathway or Solar Hot Water Ready Pathway to accommodate installation of photovoltaic (PV) or solar hot water system in the future.
<input type="radio"/> YES <input type="radio"/> NO <input type="radio"/> MAYBE	<b>8 Max</b>  <b>4-8</b>  <b>1-5</b>	<b>5.3b Moving to Zero Energy: Renewable Energy</b> (Not available for projects following Criterion 5.3a or 5.4) Install renewable energy source to provide a specified percentage of the project's estimated source energy demand. See full criterion for allowable sources. <b>Option 1:</b> For percentage of total project energy consumption provided by renewable energy. OR <b>Option 2:</b> For percentage of common area meter energy consumption provided by renewable energy.
<p><b>B</b> = Baseline <b>#</b> = OPTIONAL POINTS</p>		



<input type="radio"/> YES <input type="radio"/> NO <input type="radio"/> MAYBE	<b>24</b>	<p><b>5.4 Achieving Zero Energy</b> [5.2b or 5.4 Baseline for Iowa Green Streets Certification Plus] (Not available for projects following Criterion 5.2a, 5.2b, 5.3a, or 5.3b.) Achieve Zero Energy performance through one of the following:</p> <p><b>Option 1:</b> Certify each building in the project to DOE Zero Energy Ready Home program or PHI Plus AND Either install renewables and/or procure renewable energy, which in sum will produce as much, or more, energy in a given year than the project is modeled to consume.</p> <p>OR</p> <p><b>Option 2:</b> Certify each building in the project in a program that requires zero energy performance such as PHIUS_ Source Zero, PHI Plus, PHI Premium, ILFI's Zero Energy Petal, Zero Carbon Petal, or Living Building Certification.</p>
<input type="radio"/> YES <input type="radio"/> NO <input type="radio"/> MAYBE	<b>5 Max</b>	<p><b>5.5a Moving to Zero Carbon: All-Electric Ready</b> [Baseline for Disaster Recovery Housing Projects] (Not available for projects following Criterion 5.5b)</p> <p>Ensure the project has adequate electric service and has been designed and wired to allow for a seamless switch to electricity as a fuel source in the future for the following uses: space heating [1 point], space cooling [1 point], water heating (DHW) [1 point], clothes dryers [1 point], equipment for cooking [1 point].</p>
<input type="radio"/> YES <input type="radio"/> NO <input type="radio"/> MAYBE	<b>15</b>	<p><b>5.5b Moving to Zero Carbon: All Electric</b> [Disaster Recovery Projects seeking Iowa Green Streets Certification Plus may request additional funding with proof of additional costs] (Not available for projects following Criterion 5.5a)</p> <p>No combustion equipment used as part of the building project; project is all-electric.</p>
<input type="radio"/> YES <input type="radio"/> NO <input type="radio"/> MAYBE	<b>B</b>	<p><b>5.6 Sizing of Heating and Cooling Equipment</b> (Baseline for Substantial and Moderate Rehabs that include replacement of heating and cooling equipment.)</p> <p>Size and select heating and cooling equipment in accordance with ACCA manuals J, S, and D OR in accordance with the ASHRAE Handbook of Fundamentals.</p>
<input type="radio"/> YES <input type="radio"/> NO <input type="radio"/> MAYBE	<b>B</b>	<p><b>5.7 ENERGY STAR Appliances</b> (Baseline if providing appliances.)</p> <p>Install ENERGY STAR clothes washers, dishwashers, and refrigerators. If appliances will not be installed or replaced at this time, specify that at the time of installation or replacement, ENERGY STAR models must be used via Criterion 8.1 and Criterion 8.4.</p>
<input type="radio"/> YES <input type="radio"/> NO <input type="radio"/> MAYBE	<b>B</b>	<p><b>5.8 Lighting</b> (Baseline for all lighting within New Construction and Substantial Rehab projects. Baseline for new lighting in Moderate Rehab projects.)</p> <p>Follow the guidance for high-efficacy permanently installed lighting and other characteristics for recessed light fixtures, lighting controls, lighting power density, and exterior lighting.</p>
<input type="radio"/> YES <input type="radio"/> NO <input type="radio"/> MAYBE	<b>8</b>	<p><b>5.9 Resilient Energy Systems: Floodproofing</b> (Not relevant for Rehab projects in Special Flood Hazard Areas)</p> <p>Conduct floodproofing of lower floors, including perimeter floodproofing (barriers/shields). Design and install building systems as specified by the full criterion so that operation of those systems will not be grossly affected in a flood.</p>
<p><b>B</b> = Baseline  <b>#</b> = OPTIONAL POINTS</p>		



<input type="radio"/> YES <input type="radio"/> NO <input type="radio"/> MAYBE	<b>8</b>	<p><b>5.10 Resilient Energy Systems: Critical Loads</b> Provide emergency power to serve at least three critical energy loads as described by the full criterion. <b>Option 1:</b> Islandable PV system OR <b>Option 2:</b> Efficient generator</p>
<input type="radio"/> YES <input type="radio"/> NO <input type="radio"/> MAYBE	<b>5-10</b>	<p><b>5.11 Electric Vehicle Charging</b> <i>[Disaster Recovery Projects seeking Iowa Green Streets Certification Plus may request additional funding with proof of additional costs].</i> <b>Option 1 [5 points]</b> Install panel capacity and raceway (≥ size 1) to support future build-out of EV charging with 208/240 V, 40-amp circuits. Identify the overcurrent protective device space(s) on circuit directory as “EV CAPABLE.”  <b>Option 2 [10 points]</b> Residential projects ≥ 2 units install ≥ 1 <u>active</u> electric vehicle charging station. For multifamily and commercial projects install ≥ 2 active charging stations for first 25 parking spaces and 10% of all parking spaces &gt; 25 (round up).</p>
<input type="radio"/> YES <input type="radio"/> NO <input type="radio"/> MAYBE	<b>B</b>	<p><b>5.12 Advanced Framing</b> Use advanced framing (optimum value engineering) best practices for all framing.</p>
<input type="radio"/> YES <input type="radio"/> NO <input type="radio"/> MAYBE	<p><b>5-15</b></p> <p><b>5</b></p> <p><b>10</b></p> <p><b>15</b></p>	<p><b>5.13 FORTIFIED Roofs and Homes</b></p> <p>FORTIFIED Roof — When re-roofing an existing building or constructing a new building, achieve FORTIFIED Roof (High Wind &amp; Hail) certification. <i>[5 points]</i></p> <p>FORTIFIED Silver — When constructing a new building or home, achieve FORTIFIED Silver certification. <i>[10 points]</i></p> <p>FORTIFIED Gold — When constructing a new building or home, achieve FORTIFIED Gold certification. <i>[15 points]</i></p>
		SUBTOTAL OPTIONAL POINTS
<p><b>B</b> = Baseline <b>#</b> = OPTIONAL POINTS</p>		
<b>6. MATERIALS</b>		
<input type="radio"/> YES <input type="radio"/> NO <input type="radio"/> MAYBE	<b>8 Max</b>	<p><b>6.1 Ingredient Transparency for Material Health</b> Install products that have publicly disclosed inventories characterized and screened to 1,000 ppm or better:</p> <ul style="list-style-type: none"> <li>· 1 point per 5 installed Declare or HPD products from at least three different product categories.</li> <li>· 1 point per 2 installed Declare or HPD products in any of these categories: adhesives, sealants, windows.</li> <li>· 1 point per each product with third-party verified HPD or third party verified Declare label.</li> <li>· 2 points per each product with third-party verified HPD or third party verified Declare label in any of these categories: adhesives, sealants, windows.</li> </ul>



<input type="radio"/> YES <input type="radio"/> NO <input type="radio"/> MAYBE	<b>3 Max</b>	<b>6.2 Recycled Content and Ingredient Transparency</b> Use building products that feature, and disclose, their recycled content. The building product must make up 75% by weight or cost of a project category for the project and be composed of at least 25% post-consumer recycled content.
<input type="radio"/> YES <input type="radio"/> NO <input type="radio"/> MAYBE	<b>8 Max</b>	<b>6.3 Chemical Hazard Optimization</b> Install products that have third-party verification of optimization to 100 ppm or better per the options listed within the full criterion.
<b>B</b> = Baseline # = OPTIONAL POINTS		
<input type="radio"/> YES <input type="radio"/> NO <input type="radio"/> MAYBE	<b>B</b> <b>15 Max</b>	<b>6.4 Healthier Material Selection</b> Select all interior paints, coatings, primers, and wallpaper; interior adhesives and sealants; flooring; insulation; and composite wood as specified. Optional points also available.
<input type="radio"/> YES <input type="radio"/> NO <input type="radio"/> MAYBE	<b>12 Max</b>	<b>6.5 Environmentally Responsible Material Selection</b> Select concrete, steel, or insulation with a publicly disclosed EPD [ <i>3 points</i> ], Install a green or cool roof [ <i>3 points</i> ], use reflective paving [ <i>3 points</i> ], and/or use FSC certified wood [ <i>3 points</i> ]. Refer to criterion for specifics.
<input type="radio"/> YES <input type="radio"/> NO <input type="radio"/> MAYBE	<b>B</b>	<b>6.6 Bath, Kitchen, Laundry Surfaces</b> <i>(Baseline for New Construction and Substantial Rehab. Moderate Rehabs that do not include work in the shower and tub areas are exempt from the shower and tub enclosure requirement.)</i> Use materials that have durable, cleanable surfaces throughout bathrooms, kitchens, and laundry rooms. Use moisture-resistant backing materials per ASTM # D 6329 or 3273 behind tub/shower enclosures, apart from one-piece fiberglass enclosures which are exempt.
<input type="radio"/> YES <input type="radio"/> NO <input type="radio"/> MAYBE	<b>4 Max</b>	<b>6.7 Regional Materials</b> <i>[Baseline for Iowa Green Streets Certification Plus]</i> Use products that were processed and manufactured regionally. Select any or all of these options (every two compliant materials can qualify for 1 point): · Framing · Cladding (e.g. siding, masonry, roofing) · Flooring · Concrete/cement and aggregate · Drywall/interior sheathing
<input type="radio"/> YES <input type="radio"/> NO <input type="radio"/> MAYBE	<b>B</b>	<b>6.8 Managing Moisture: Foundations</b> <i>(Baseline for all New Construction projects and for all Rehab projects replacing/modifying basement or crawl space)</i> Install capillary breaks and vapor retarders that meet specified criteria appropriate for the foundation type.
<input type="radio"/> YES <input type="radio"/> NO <input type="radio"/> MAYBE	<b>B</b>	<b>6.9 Managing Moisture: Roofing and Wall Systems</b> <i>(Baseline for all Rehab projects that include deficiencies in or replacing assemblies called out below.)</i> Provide water drainage away from walls, window, and roofs by implementing the list of techniques.
<input type="radio"/> YES <input type="radio"/> NO <input type="radio"/> MAYBE	<b>B</b> <b>6 Max</b>	<b>6.10 Construction Waste Management</b> Develop and implement a waste management plan that reduces non-hazardous construction and demolition waste through recycling, salvaging, or diversion strategies through one of the three options. Achieve optional points by going above and beyond the requirement.



<input type="radio"/> YES <input type="radio"/> NO <input type="radio"/> MAYBE	<b>12 Max</b>	<b>6.11 Recycling Storage</b> For projects with municipal recycling infrastructure and/or haulers, provide separate bins for the collection of trash and recycling for each dwelling unit and all shared community rooms. <b>OR</b> For projects without that infrastructure, advocate to the local waste hauler or municipality for regular collection of recyclables.
		SUBTOTAL OPTIONAL POINTS
<b>B = Baseline</b> <b># = OPTIONAL POINT</b>		
<b>7. HEALTHY LIVING ENVIRONMENT</b>		
<input type="radio"/> YES <input type="radio"/> NO <input type="radio"/> MAYBE	<b>B</b>	<b>7.1 Radon Mitigation</b> <i>(Baseline for New Construction and Substantial Rehab)</i> For New Construction in EPA Zone 1 areas, install passive radon-resistant features below the slab and a vertical vent pipe with junction box within 10 feet of an electrical outlet in case an active system should prove necessary in the future. For Substantial Rehab projects in EPA Zone 1, test before and after the retrofit and mitigate per the specified protocols.
<input type="radio"/> YES <input type="radio"/> NO <input type="radio"/> MAYBE	<b>B</b>	<b>7.2 Reduce Lead Hazards in Pre-1978 Buildings</b> <i>(Baseline for Substantial Rehab of Buildings Constructed Before 1978)</i> Conduct lead risk assessment or inspection to identify lead hazards. Control identified lead hazards using lead abatement or interim controls, using lead-safe work practices that minimize and contain dust.
<input type="radio"/> YES <input type="radio"/> NO <input type="radio"/> MAYBE	<b>B</b>	<b>7.3 Combustion Equipment</b> <b>For New Construction and Rehab projects:</b> Specify power-vented or direct-vent equipment when installing any new combustion appliance for space or water heating that will be located within the conditioned space. If there are any combustion appliances within the conditioned space, install one hard-wired carbon monoxide (CO) alarm with battery backup function for each sleeping zone, placed per National Fire Protection Association (NFPA) 72.  <b>For Rehabs:</b> If there is any combustion equipment located within the conditioned space for space or water heating that is not power-vented or direct-vent and that is not scheduled for replacement, conduct combustion safety testing prior to and after the retrofit; remediate as indicated.
<input type="radio"/> YES <input type="radio"/> NO <input type="radio"/> MAYBE	<b>B</b>	<b>7.4 Garage Isolation</b> <ul style="list-style-type: none"> <li>· Provide a continuous air barrier between the conditioned space and any garage space to prevent the migration of any contaminants into the living space. Visually inspect common walls and ceilings between attached garages and living spaces to ensure that they are air-sealed before insulation is installed.</li> <li>· Do not install ductwork or air handling equipment for the conditioned space in a garage.</li> <li>· Fix all connecting doors between conditioned space and garage with gaskets or make airtight.</li> <li>· Install one hard-wired CO alarm with battery backup function for each sleeping zone of the project, placed per NFPA 72 unless the garage is mechanically ventilated or an open parking structure.</li> </ul>
<input type="radio"/> YES <input type="radio"/> NO <input type="radio"/> MAYBE	<b>B</b>	<b>7.5 Integrated Pest Management</b> Seal all wall, floor, and joint penetrations with low-VOC caulking or other appropriate nontoxic sealing methods to prevent pest entry.



<input type="radio"/> YES <input type="radio"/> NO <input type="radio"/> MAYBE	<b>B</b>    <b>10</b>	<b>7.6 Smoke-Free Policy</b> <i>(Baseline and Optional)</i> <b>Baseline:</b> Implement and enforce a smoke-free policy in all common area and within a 25-foot perimeter around the exterior of all residential buildings. Lease language must prohibit smoking in these locations and provide a graduated enforcement policy. Make the smoke-free policy readily available.  <b>Optional:</b> Expand the policy above to include all indoor spaces in the property.
<b>B = Baseline</b> <b># = OPTIONAL POINT</b>		
<input type="radio"/> YES <input type="radio"/> NO <input type="radio"/> MAYBE	<b>B</b> <b>12</b> <b>Max</b>	<b>7.7 Ventilation</b> <i>(Baseline for New Construction and Substantial Rehab; Optional for Moderate Rehab)</i> For each dwelling unit in full accordance with the current version of ASHRAE 62.2 or 62.1 as coordinated with the adopted edition of the IECC for the State of Iowa, install: <ul style="list-style-type: none"> <li>· A local mechanical exhaust system in each bathroom [3 points if Moderate Rehab]</li> <li>· A local mechanical exhaust system in each kitchen [3 points if Moderate Rehab]</li> <li>· A whole-house mechanical ventilation system [3 points if Moderate Rehab]</li> </ul> Verify these flow rates are either within +/- 15 CFM or +/- 15% of design value. Each multifamily building ≥ 4 stories, in accordance with the current version of ASHRAE 62.2 or 62.1 as coordinated with the adopted edition of the IECC for the State of Iowa, install: <ul style="list-style-type: none"> <li>· A mechanical ventilation system for all hallways and common spaces [3 points if Moderate Rehab]</li> </ul> For all project types, in addition to the above requirements: <ul style="list-style-type: none"> <li>· All systems and ductwork installed per manufacturer’s recommendations</li> <li>· All bathroom fans ENERGY STAR-labeled and wired for adequate run-time.</li> <li>· If using central ventilation systems with rooftop fans, each fan must be direct-drive and variable-speed with speed controller mounted near the fan. Fans with design CFM 300-2000 must also have an ECM motor.</li> </ul>
<input type="radio"/> YES <input type="radio"/> NO <input type="radio"/> MAYBE	<b>B</b>	<b>7.8 Dehumidification</b> <b>Option 1:</b> Design, select, and install supplemental dehumidification equipment to keep relative humidity <60%. OR <b>Option 2:</b> Equip all dwelling units with dedicated space, drain, and electrical hook-ups for permanent supplemental dehumidification systems to be installed if needed and install interior RH monitoring equipment as described.
<input type="radio"/> YES <input type="radio"/> NO <input type="radio"/> MAYBE	<b>3</b>	<b>7.9 Construction Pollution Management</b> <b>Option 1:</b> Earn the EPA Indoor airPlus label OR <b>Option 2:</b> In all dwelling units, seal all heating, cooling, and ventilation return and supply floor ducts and returns throughout construction to prevent construction debris from entering. Flush all dwelling units after completion of construction and prior to occupancy for either 48 hours or with at least 14,000 ft <sup>3</sup> per ft <sup>2</sup> of floor area, then replace all air handling equipment filters.



<input type="radio"/> YES <input type="radio"/> NO <input type="radio"/> MAYBE	<b>3</b>	<b>7.10 Noise Reduction</b> <b>Option 1:</b> Test and demonstrate that noise levels in bedrooms meet 30 dB LAeq (continuous) and 45 dB LAmax, (single sound). OR <b>Option 2:</b> Provide a noise abatement plan specific to the site covering general noise mitigation techniques in accordance with 24 CFR 51B. OR <b>Option 3:</b> Ensure all exterior wall and party wall penetrations are sealed with acoustical sealant, all party walls and floor/ceiling assemblies have an STC rating of at least 55, and exterior windows and doors in projects near a significant exterior noise source have an STC rating of at least 35.
<b>B</b> = Baseline <b>#</b> = OPTIONAL POINT		
<input type="radio"/> YES <input type="radio"/> NO <input type="radio"/> MAYBE	<b>8</b>	<b>7.11 Active Design: Promoting Physical Activity</b> <b>Option 1:</b> Encouraging Everyday Stair Usage (buildings that include stairs as the only means to travel from one floor to another are not eligible for this option.) Provide a staircase that is accessible and visible from the main lobby and is visible within a 25-foot walking distance from any point in the lobby per the specifications listed. Place point-of-decision signage. OR <b>Option 2:</b> Activity Spaces. Provide on-site dedicated recreation space with exercise or play opportunities for adults and/or children that is open and accessible to all residents; see criterion for specifics.
<input type="radio"/> YES <input type="radio"/> NO <input type="radio"/> MAYBE	<b>10</b>   <b>7</b>	<b>7.12 Beyond ADA: Universal Design</b> <b>Optional [10 points]:</b> Implement Division 1, Best Practices, of the Iowa Green Streets Criteria Universal Design Best Practices Checklist. One point for each section implemented (i.e., Section 1 Entrance, Section 2 Circulation, Section 3 Bathrooms, etc.) up to a total of 10 points.  <b>Optional [7 points]:</b> Implement Division 2, Best Practices, of the Iowa Green Streets Criteria Universal Design Required and Bonus Best Practices Checklist. One point for each numbered item best practice to be implemented (i.e., 1.2, 3.3, 3.6, 4.3, 4.4, 6.2, 10.1) up to a total of 7 points.
<input type="radio"/> YES <input type="radio"/> NO <input type="radio"/> MAYBE	<b>8</b>	<b>7.13 Healing-Centered Design</b> Select and implement at least two of the Options with at least two different strategies listed in at least 75% units. <b>Option 1:</b> Provide an environment that promotes feelings of real and perceived safety. <b>Option 2:</b> Create flexible spaces that allow for personalization and/or manipulation to meet individual and community needs. <b>Option 3:</b> Connect residents and staff to a living landscape and the natural environment. <b>Option 4:</b> Utilize art and culture in project design and programming and promote social connectedness.
		SUBTOTAL OPTIONAL POINTS
<b>B</b> = Baseline <b>#</b> = OPTIONAL POINT		<b>8. OPERATIONS, MAINTENANCE + OCCUPANT ENGAGEMENT</b>





<input type="radio"/> YES <input type="radio"/> NO <input type="radio"/> MAYBE	<b>B</b>	<p><b>8.1 Building Operations &amp; Maintenance Manual and Plan</b> <i>(For all Multifamily, Commercial and Mixed-Use projects)</i>                  Develop a manual with thorough building operations and maintenance (O&amp;M) guidance and a complementary plan. The manual and plan should be developed over the course of the project design, development, and construction stages, and should include sections/chapters addressing the list of topics.</p>
<b>B</b> = Baseline <b>#</b> = OPTIONAL POINT		
<input type="radio"/> YES <input type="radio"/> NO <input type="radio"/> MAYBE	<b>B</b>	<p><b>8.2 Emergency Management Manual</b> <i>(For all Multifamily, Commercial and Mixed-Use projects)</i>                  Provide a manual on emergency operations targeted toward operations and maintenance staff and other building-level personnel. The manual should address responses to various types of emergencies, leading with those that have the greatest probability of negatively affecting the project. The manual should provide guidance as to how to sustain the delivery of adequate services throughout an emergency and cover a range of topics, including but not limited to:</p> <ul style="list-style-type: none"> <li>· communication plans for staff and residents</li> <li>· useful contact information for public utility and other service providers</li> <li>· infrastructure and building “shutdown” procedures</li> <li>· plan for regular testing of backup energy systems, if backup systems exist</li> </ul>
<input type="radio"/> YES <input type="radio"/> NO <input type="radio"/> MAYBE	<b>B</b>	<p><b>8.3 Occupant Manual</b>                  Provide a guide for building tenants and residents that explains the intent, benefits, use and maintenance of their building’s green features and practices. The Occupant Manual should encourage green and healthy activities per the list of topics.</p>
<input type="radio"/> YES <input type="radio"/> NO <input type="radio"/> MAYBE	<b>B</b>	<p><b>8.4 Walk-Throughs and Orientations to Property Operation</b>                  Provide a comprehensive walk-through and orientation for all residents, property manager(s), and buildings operations staff.</p>
<input type="radio"/> YES <input type="radio"/> NO <input type="radio"/> MAYBE	<b>B</b>	<p><b>8.5 Energy and Water Data Collection and Monitoring</b>                  For rental properties, upload project energy and water performance data in an online utility benchmarking platform annually for at least five years from time of construction completion per one of the four methods provided; grant IEDA view access for that period. For owner-occupied units, collect and monitor utility data in a manner that allows for easy access and review.</p>
		SUBTOTAL OPTIONAL POINTS
		TOTAL OPTIONAL POINTS



## INTEGRATIVE DESIGN

INTRODUCTION CRITERIA  
CHECKLIST

- 1 INTEGRATIVE DESIGN
- 2 LOCATION +  
NEIGHBORHOOD FABRIC
- 3 SITE IMPROVEMENT
- 4 WATER
- 5 OPERATING ENERGY
- 6 MATERIALS
- 7 HEALTHY LIVING  
ENVIRONMENT
- 8 OPERATIONS,  
MAINTENANCE  
+ OCCUPANT  
ENGAGEMENT

APPENDIX

A SUCCESSFUL INTEGRATIVE  
DESIGN PROCESS  
ENGAGES PEOPLE,  
IDENTIFIES COLLECTIVE  
PRIORITIES, AND ENSURES  
THAT SUSTAINABILITY,  
HEALTH, RESILIENCE, AND  
PLACEMAKING OBJECTIVES  
ARE MET.

# 1.1

## BASELINE INTEGRATIVE DESIGN: PROJECT PRIORITIES SURVEY

### RATIONALE

A successful integrative design process is more art than science. It also is often the determining factor in ultimately achieving a successful project. At this early phase of pre-development, it's critical for project teams to understand many facets of the development, including the residents and their needs, the community at large, and environmental stressors that affect a person or occupant's health and well-being—this is what an integrative design process can do.

Integrative design is a holistic approach to pre-development that prioritizes information gathering, understanding and prioritizing the occupant experience, and setting objectives for building performance and occupant health and comfort, as well as project coordination and buy-in from all related development stakeholders.

By seeking out readily available information and engaging in an integrative design process, teams can gain a holistic understanding of the context, place, and population they are serving. This will help teams shape their priorities to drive project decisions. This understanding can also be used to garner project support and demonstrate need and may support documentation for funding applications.

### REQUIREMENTS

Complete the Project Priorities Survey, which can be found in Appendix K. Once completed, the Project Priorities Survey will serve as a simple guide to understand the context, population, and environmental considerations that your development must address to facilitate a well-informed integrative design process.

### RECOMMENDATIONS

- Complete the Project Priorities Survey with as much of your development team as has been identified. Pre-construction coordination and goal setting ensures all development team members are aligned to specific development goals.
- The ideal time to complete the Project Priorities Survey should be determined by the design and development team. It should be completed early enough in the design phase (conceptual design or schematic design) where the completed Survey can positively influence design decisions as they are made.
- Engage relevant data sets and challenge assumptions of everyone on the development team.
- Qualitative data, especially from current or potential residents, is also a critical source of information, and can be used to confirm or counter quantitative data you may research.

## RESOURCES

- Opportunity360 Listen, Community Engagement Toolkit. Listening to the perspectives of the people in a community is critical to the change process. The tools below allow you to engage with residents, stakeholders, and community developers to better advance meaningful strategies to address the challenges in your community.  
[www.enterprisecommunity.org/opportunity360/community-engagement-toolkit](http://www.enterprisecommunity.org/opportunity360/community-engagement-toolkit)
- Opportunity360 Measurement Report. Opportunity360 measures five foundational criteria shown to have the greatest impact on how we live. The information provided by each neighborhood-level report can help us all better understand how to ensure that communities are inclusive, equitable, and thriving.  
[www.enterprisecommunity.org/opportunity360/measure](http://www.enterprisecommunity.org/opportunity360/measure)
- Enterprise Community Partners, Design Matters. This is an interactive, web-based portal that helps designers and developers co-create a better integrative design process through engaging tools and worksheets. [www.enterprisecommunity.org/solutions-and-innovation/design-leadership/designmatters](http://www.enterprisecommunity.org/solutions-and-innovation/design-leadership/designmatters)
- Enterprise Community Partners, The Success of Charrettes: Evidence in Practice for Engaging in an Integrative Design Approach (2011). [www.enterprisecommunity.org/solutions-and-innovation/green-communities/tools-and-services/charrette-toolkit](http://www.enterprisecommunity.org/solutions-and-innovation/green-communities/tools-and-services/charrette-toolkit)
- Enterprise Community Partners, Green Charrette Tools. [www.enterprisecommunity.org/solutions-and-innovation/green-communities/tools-and-services/charrette-toolkit](http://www.enterprisecommunity.org/solutions-and-innovation/green-communities/tools-and-services/charrette-toolkit). This website contains a series of tools and trainings that can help any project team develop and deliver a robust integrative design process.
- Enterprise Green Communities maintains a comprehensive registry of qualified green affordable housing technical assistance (TA) providers that are available for support on the design, construction, rehabilitation, and operations of green affordable housing. To find a Green TA provider near you, search the list found at [www.enterprisecommunity.org/solutions-and-innovation/green-communities/tools-and-services/technical-assistance-providers-database](http://www.enterprisecommunity.org/solutions-and-innovation/green-communities/tools-and-services/technical-assistance-providers-database)
- Enterprise Community Partners, Participatory Design Toolkit. This toolkit, developed by a designer working in a community development organization, offers strategies to engage and involve the community in design projects. It is packed with activities, tips, and techniques to foster dialogue and create informed design goals.  
[www.enterprisecommunity.org/resources/participatory-design-toolkit-13221](http://www.enterprisecommunity.org/resources/participatory-design-toolkit-13221)
- Participate In Design. Outlines different principals of participatory design.  
[participateindesign.org/approach/tools](http://participateindesign.org/approach/tools)
- Strive Together, Ten Principles of Authentic Community Engagement.  
[www.strivetgether.org/wp-content/uploads/2017/03/10\\_principles\\_community\\_engagement\\_2.pdf](http://www.strivetgether.org/wp-content/uploads/2017/03/10_principles_community_engagement_2.pdf)
- How Housing Matters, Nine Critical Steps for Authentic Community Engagement.  
[howhousingmatters.org/articles/nine-critical-steps-authentic-community-engagement/](http://howhousingmatters.org/articles/nine-critical-steps-authentic-community-engagement/)

## 1.2

# BASELINE INTEGRATIVE DESIGN: CHARRETTES AND COORDINATION MEETINGS

## RATIONALE

An Integrative Design process is helpful in maximizing project budget and impact through a holistic, comprehensive approach. An integrative project delivery process facilitates the design and development team's achievement of green objectives, positive health, and community outcomes throughout the development life cycle by advancing multi-benefit strategies.

Green design charrettes can be powerful opportunities to educate and align stakeholders with the goals and objectives of a project and to tap into the collective wisdom of the group. Smaller multi-disciplinary teams may also be brought together to analyze and develop integrated solutions to complex design challenges that require multiple perspectives to resolve perceived conflict, between first cost and operational costs. Pre-development is also an important moment to ensure that lessons learned through maintenance of other projects are woven into design decisions made about your current project.

The outcomes of an integrative project delivery process may include substantially lower development costs and greater health, economic, environmental, and social benefits for residents, property owners, and communities.

## REQUIREMENTS

Develop an integrative design process that works best for your project team and intentions. At minimum, project teams should develop:

- An integrative process that takes the research and learnings of the Project Priorities Survey (Criterion 1.1) and moves them into action. The process should prioritize collaborative meeting formats, such as:
  - Green charrette(s)
  - Preconstruction coordination planning meeting(s)
  - Construction coordination meeting(s)
  - Occupant/resident engagement/community meetings

These collaborative meeting formats should be used, in some combination, to:

- Productively and regularly engage occupants, residents and/or community members
- Include lessons learned from existing projects
- Identify green and resilience objectives for the project
- Complete an Iowa Green Streets Criteria Quick Reference checklist with the entire design and development team
- Coordinate pre-development research and work

- Confirm that the documents (plans, specifications, scope(s) of work) reflect the completed Iowa Green Streets Criteria Green Development Plan and checklist, as the project transitions from Design Development to Construction Document phase
- Confirm that green objectives for the project are incorporated into design
- Throughout your integrative process, as decisions about sustainability strategies are being considered, place priority on multi-benefit strategies that achieve multiple green, health and well-being, environmental resilience, and community/social resilience goals concurrently.
- As research and decisions are being made during pre-development, assign responsibility within your design and development team(s) to create accountability. When certain professionals and trades—or better still, individuals—are assigned responsibility for tasks, those tasks have a higher likelihood of being completed.

## RECOMMENDATIONS

- Consider tracking meeting minutes, attendees, topics discussed, and decisions made in an online database that is searchable. This can be a valuable resource when personnel working on projects can change over the long duration of the design and construction process.
- Include a training session for community members to be educated about the basics of green design, and its benefits and trade-offs, and be informed about the latest trends in green construction methods so that the public can provide detailed, constructive feedback to the design and development team during engagement sessions.
- Prioritize holistic goal setting. The mission statement and research developed through the Project Priorities Survey (Criterion 1.1) should be used to solidify project goals and strategies. Some questions to consider may be:
  - How can the project leverage multi-benefit strategies to holistically address climate and human resilience?
  - Does the project consider the synergies and overlap between the eight categories of the Iowa Green Streets Criteria?
  - Are equity and climate change considered throughout the decision-making process?
  - Are both life cycle and upfront costs being considered when making decisions about systems and materials?
  - Have current, or potential, occupants/residents been involved throughout the pre-development process?
  - Have they been actively engaged? Have they had a voice in the process?
- Building operators of similar projects often have key insights that are helpful when making important decisions at the pre-development phase. Have building operations and maintenance staff been consulted on systems selection? Finish materials selection? Climate concerns, connected to resilience strategies?
- Use data from your previous projects as baselines to inform your goals for your current project. For example: evaluate your portfolio energy and water consumption (per bedroom), your health needs assessment data, and your financial data, including pro-forma assumptions broken down more finely regarding operating expense categories.
- Consider creating incentives for your construction team based on the performance of various building components.

---

## RESOURCES

- Enterprise Community Partners, The Success of Charrettes: Evidence in Practice for Engaging in an Integrative Design Approach (2011).  
[www.enterprisecommunity.org/solutions-and-innovation/green-communities/tools-and-services/charrette-toolkit](http://www.enterprisecommunity.org/solutions-and-innovation/green-communities/tools-and-services/charrette-toolkit)
- Enterprise Community Partners, Green Charrette Tools. This website contains a series of tools and trainings that can help any project team develop and deliver a robust integrative design process.  
[www.enterprisecommunity.org/solutions-and-innovation/green-communities/tools-and-services/charrette-toolkit](http://www.enterprisecommunity.org/solutions-and-innovation/green-communities/tools-and-services/charrette-toolkit)
- Enterprise Community Partners, Participatory Design Toolkit. This toolkit, developed by a designer working in a community development organization, offers strategies to engage and involve the community in design projects. It is packed with activities, tips and techniques to foster dialogue and create informed design goals.  
[www.enterprisecommunity.org/resources/participatory-design-toolkit-13221](http://www.enterprisecommunity.org/resources/participatory-design-toolkit-13221)
- Enterprise Community Partners, Aging in Place Prioritization Charrette Tool. This resource, with instructions, features a prioritization matrix to help collect, organize, and prioritize aging-in- place strategies.  
[www.enterprisecommunity.org/resources/aging-place-prioritization-charrette-tool-directions-13430](http://www.enterprisecommunity.org/resources/aging-place-prioritization-charrette-tool-directions-13430)
- Whole Building Design Guide. This website describes the core elements of “whole building design,” which includes the combination of an integrative design approach and an integrative team process. This site helps users identify design objectives and organize their processes to meet those objectives.  
[www.wbdg.org/wbdg\\_approach.php](http://www.wbdg.org/wbdg_approach.php)
- The Integrative Design Guide to Green Building, Redefining the Practice of Sustainability, 7group and Bill Reed (2009). This book provides guidance to building professionals on incorporating integrative design into every phase of a project. [sevengroup.com/integrative\\_design\\_guide/](http://sevengroup.com/integrative_design_guide/)

## 1.3

# BASELINE INTEGRATIVE DESIGN: DOCUMENTATION

### RATIONALE

Projects that intentionally create accountability among project team members to meet the Enterprise Green Communities Criteria through design and construction documentation successfully implement the Criteria on-site during the construction phase. An evaluation of the pre-development process Enterprise Green Communities found that development teams that prioritized documentation of Enterprise Green Communities Criteria were 95% more likely to have those materials or methods show up in the final building.

### REQUIREMENTS

In the construction/contract documents for the project, including but not limited to drawing set and scope(s) of work, include all the information needed to properly implement the measures intended to meet Iowa Green Streets Criteria and other mission-critical design features. Include Iowa Green Streets Criteria information in your construction specifications, in Division 1 Section 01 81 13 Sustainable Design Requirements, as necessary for the general contractor to understand the requirements and how they will be verified. Ensure, and indicate, that the drawings and specifications have been generated to be compliant and meet the certification goals. See [www.enterprisecommunity.org/solutions-and-innovation/green-communities/tools-and-services/construction-specifications](http://www.enterprisecommunity.org/solutions-and-innovation/green-communities/tools-and-services/construction-specifications).

Document all Iowa Green Streets Criteria that require the general contractor, subcontractors, or consultants to comply with a particular construction phase process (e.g., Criteria 6.10 Construction Waste Management) in other construction specifications, as appropriate.

As design progresses, evaluate how the development of the documents is addressing the goals and priorities outlined earlier in the integrative design processes, specifically in the Project Priorities Survey (Criteria 1.1).

### RECOMMENDATIONS

- Incorporate all Iowa Green Streets Criteria Baseline and optional measures that the project intends to meet.
- Plans and specifications should include a performance specification, examples of products that meet the specification, the metrics used to measure compliance, and how compliance will be confirmed.
- Architectural drawings should detail the air sealing and compartmentalization approach for the building and units. Drawings should indicate specifically which materials are considered the air barrier, and expectations for the transition of that air barrier between materials on all six sides.





---

## RESOURCES

- Enterprise Community Partners, The Success of Charrettes: Evidence in Practice for Engaging in an Integrative Design Approach (2011). [www.enterprisecommunity.org/solutions-and-innovation/green-communities/tools-and-services/charrette-toolkit](http://www.enterprisecommunity.org/solutions-and-innovation/green-communities/tools-and-services/charrette-toolkit)
- Enterprise Community Partners, Green Charrette Tools. This website contains a series of tools and trainings that can help any project team develop and deliver a robust integrative design process. [www.enterprisecommunity.org/solutions-and-innovation/green-communities/tools-and-services/charrette-toolkit](http://www.enterprisecommunity.org/solutions-and-innovation/green-communities/tools-and-services/charrette-toolkit)
- Building America's Climate-Specific Guidance ([energy.gov/eere/buildings/building-america-climate-specific-guidance](http://energy.gov/eere/buildings/building-america-climate-specific-guidance)) and the Building America Solution Center ([energy.gov/eere/buildings/building-america-solution-center](http://energy.gov/eere/buildings/building-america-solution-center)) provide residential building professionals with access to expert information on hundreds of high-performance design and construction topics. They include contracting documents and specifications, installation guidance, CAD drawings, “right and wrong” photographs of installation practices, and training videos.
- Enterprise Green Communities maintains a comprehensive registry of qualified green affordable TA providers that are available for support on the design, construction, rehabilitation, and operations of green affordable housing. To find a Green TA provider near you, search the list found at [www.enterprisecommunity.org/solutions-and-innovation/green-communities/tools-and-services/technical-assistance-providers-database](http://www.enterprisecommunity.org/solutions-and-innovation/green-communities/tools-and-services/technical-assistance-providers-database)

# 1.4

## BASELINE INTEGRATIVE DESIGN: CONSTRUCTION MANAGEMENT

### RATIONALE

Communication and education of all contractors, subcontractors, and consultants are critical to ensure that the objectives and decisions made throughout the integrative design process are implemented on-site, during construction of the project.

### REQUIREMENTS

- Create, implement, and document a contractor, subcontractor, and consultant education plan to ensure that those working on-site fully understand their role in achieving the project objectives. Information to include in the education plan must include (at a minimum):
  - A summary of the Project Priorities Survey (Criterion 1.1)
  - Sustainability goals/objectives
  - Anticipated roles of each party in regard to the performance expected of the building (energy and water usage) and site

Attach and reference this training plan to construction specifications in Division 1 Section 01 81 13 Sustainable Design Requirements.

Training with contractors, subcontractors, and consultants should focus specifically on what their responsibilities are and how that work will be evaluated by the project team.

- Include a status update regarding progress towards satisfying the Iowa Green Streets Criteria as a meeting agenda item during your construction kickoff meeting and as a regular standing agenda item for weekly construction meetings.
- Include timeline estimates for performance testing and verification schedules in the overall construction schedule (and within Division 1 Section 01 81 13 Sustainable Design Requirements) to ensure that advanced coordination can be made between installation contractors and testing and verification contractors. Estimates may be used until the final testing and verification schedules are finalized.
- As the project moves from design into construction, review requirements for Criterion 8.1, Criterion 8.2 and Criterion 8.3, and begin populating those documents with relevant information (e.g., installation documents, maintenance manuals).

## RECOMMENDATIONS

- Even if no progress is made week-to-week, the standing meeting agenda item has the impact of keeping construction team members focused on satisfying the sustainability goals of the project.
- Train and educate contractors, subcontractors, and consultants to the general contractor as they begin working on-site as to the goals of the development team and the anticipated final performance of the building. Focus your training efforts on foremen or crew bosses, or whomever is managing the work on-site. Trades that should be trained vary depending on the scope of work, but often include framing contractors, electrical contractors, plumbing contractors, insulation installers, air sealing specialists, plumbing contractors, and HVAC contractors/installers.
- Add self-verification requirements for your construction team for certain project items that demand proper installation (e.g., testing of water fixtures, testing of bath fans, air sealing of air handler closets).
- Review notes and deviations—including Request for Information (RFI) approved submittals, and Architect's Supplemental Instructions (ASIs)—should be included in construction documentation. Explanations for where and why design/specifications were changed should be clearly identified throughout final documentation. This item should be included in your construction specifications in Division 1 Section 01 81 13 Sustainable Design Requirements.

## RESOURCES

- Enterprise Community Partners, Green Charrette Tools. This website contains a series of tools and trainings that can help any project team develop and deliver a robust integrative design process. [www.enterprisecommunity.org/solutions-and-innovation/green-communities/tools-and-services/charrette-toolkit](http://www.enterprisecommunity.org/solutions-and-innovation/green-communities/tools-and-services/charrette-toolkit)
- Enterprise Green Communities maintains a comprehensive registry of qualified green affordable TA providers that are available for support on the design, construction, rehabilitation, and operations of green affordable housing. To find a Green TA provider near you, search the list found at [www.enterprisecommunity.org/solutions-and-innovation/green-communities/tools-and-services/technical-assistance-providers-database](http://www.enterprisecommunity.org/solutions-and-innovation/green-communities/tools-and-services/technical-assistance-providers-database)

# 1.5

## **OPTIONAL**

**12 POINTS FOR STEPS 1-6; ADDITIONAL 3 POINTS FOR STEP 7**

# DESIGN FOR HEALTH AND WELL-BEING: HEALTH ACTION PLAN

## **RATIONALE**

Our social and physical environments account for 50%–70% of our health outcomes. Building conditions play a significant role in this context, given that people spend at least half of every day inside. Building design, construction and operations decisions impact occupant health—whether those decisions are intentionally made in respect to health or not. Thoughtful, informed decision making can make a profound difference in the health outcomes of occupants/residents.

The Health Action Plan framework, developed as part of the release of the 2015 Enterprise Green Communities Criteria, provides owners/developers a process for integrating health into design and development activities. This innovative process pairs owners/developers with public health professionals to prioritize the health needs specific to their community through data analysis and community engagement, resulting in cost-effective strategies that amplify project goals and improve factors that drive health and well-being for building users and residents. Drawing from public health methods (including Health Impact Assessments, or HIAs), the Health Action Plan framework allows project teams to identify and address important health issues. The release of the 2020 Enterprise Green Communities Criteria revises the Health Action Plan framework to reflect the experiences and recommendations of practitioners.

## **REQUIREMENTS**

Project teams will follow the Health Action Plan process starting in pre-development and continuing throughout the project life cycle (design, construction, operations). Steps 1 through 6 are required for compliance with this criterion. Step 7 may not be feasible for all teams and is therefore available for additional points. The process includes:

1. Commit to embedding health into the project life cycle
2. Partner with a public health professional
3. Collect and analyze community health data
4. Engage with community stakeholders to prioritize health data and strategies
5. Identify strategies to address those health issues
6. Create an implementation plan
7. Create a monitoring plan [available for additional points]

## ***Specific requirements for each step***

### **Step 1. Commit to Embedding Health into the Project Life Cycle**

The first step to embarking on the Health Action Plan process is to commit to taking a health-informed approach to development. This commitment undergirds all subsequent actions and should be made early, ideally during schematic design. As part of this commitment, assess where the project is in its life cycle to ensure that data collected and strategies selected can be integrated into the design, construction, and operations of the development; allocate time and funds to partner with a public health professional and engage community stakeholders; and commit to integrating feasible strategies that can improve health outcomes.

### **Step 2. Partner with a Public Health Professional**

Formally partner with a public health professional to support data collection and analysis (Step 3), community engagement (Step 4), and development of evidence-based strategies (Steps 5 & 6) to address the health needs that emerge from the Health Action Plan process. The public health professional must have expertise in:

- Accessing, analyzing, and disaggregating local public health data (including social, environmental, and economic factors contributing to health needs)
- Facilitating resident and community engagement to reveal community health priorities
- Identifying evidence-based strategies that can be utilized in the design, construction, and operations process to promote health
- If pursuing Step 7, identifying methods and metrics for monitoring impact of built environment strategies on resident health

*Consider:* Public health professionals may be public health consultants, faculty or graduate students of public health programs, staff of public health institutes or departments and/or community-based public health organizations, architects or green consultants with public health training (e.g., MPH), and/or, potentially, individuals from other types of organizations such as hospitals. The qualifications (four factors listed above) of the individual and their capacity to serve in this role for the duration of the project are of higher priority than the type of organization within which that individual is based.

In addition to the public health professional on record for the project, project teams may have opportunity to incorporate the advice and expertise of other health professionals in the Health Action Plan during Step 4, stakeholder engagement, or the formation of an advisory board to provide review and input into this process.

See Resources for a template Public Health Professional Scope of Work and a list of pre-vetted public health professionals. Consider interviewing a few candidates before selecting the final public health professional for your project.

### **Step 3. Collect and Analyze Publicly Available Community Health Data**

The public health professional, in partnership with the project team, will conduct research on resident health factors by accessing and analyzing publicly available data sources. These data sources will likely include community health assessments and plans relevant to your community conducted by organizations like not-for-profit hospitals and public health departments. Access and analyze data that is as specific to the location and demographic served by the project as possible. Analyze the data to identify the project's potential connections to health and the baseline health conditions of the people who live or are most likely to live in or utilize the building or be impacted by the project.

When possible, disaggregate the data by race, ethnicity, income, age, and/or gender. This disaggregation will reveal health disparities, a health difference linked closely to social, economic, and/or environmental disadvantage, specific to your community. Understanding health disparities, and why they are occurring, will allow the project team to develop strategies aimed to close the gaps in health outcomes between different groups in your community.

---

#### **Step 4. Engage with Community Stakeholders to Prioritize Health Data and Strategies**

The public health professional and project team will engage community stakeholders to better understand and prioritize the health issues identified during Step 3, refining what was learned in the data collection phase based on the lived experience and preferences of the impacted community. Use this information to inform potential types of design, construction, and/or operational solutions that could address those health needs.

*Consider:* When soliciting feedback on potential types of solutions, the public health professional shall frame the conversation to identify preferences for different types of interventions that would be effective, rather than focus on specific interventions themselves, as the project team will likely not be able to confirm feasibility of specifics at this point in the project life cycle. For instance, rather than asking the community stakeholders to rank their preference for specific interventions (e.g., exercise room, advanced HVAC filtration system), work toward understanding and agreement from the community stakeholders on the areas of health that are their highest priority (e.g., obesity or indoor air quality or safety) and the type (e.g., more opportunities for physical activity, improved unit-based air quality) of desired solutions associated with it.

Community stakeholders may include community members who live in or may be served directly by the project; individuals who live, work, or learn in the neighborhood surrounding the project; those who provide services or programming in the building or in the neighborhood surrounding the project; and stakeholders with expertise in the health needs of community members (e.g., public health department, hospitals). When engaging stakeholders, consider the groups disproportionately impacted by health issues in your community to ensure that their voices are represented during this outreach.

#### **Step 5. Identify Strategies to Address Those Health Issues**

Given the data and feedback collected in Steps 3 and 4, the project team will work closely with the public health professional to characterize how the project may impact—both positively and negatively—health outcomes for residents and, in turn, identify potential actions that could be implemented within the project's design, construction, or operation to enhance health-supportive features of the project and minimize potential health risks.

*Consider:* In identifying strategies, the project team and public health professional should also consider how to build in adaptability in addressing health needs as residents/occupants age in the building and as health needs change in response to our changing climate.

#### **Step 6. Create an Implementation Plan**

Based on the list of potential interventions generated in Step 5, project teams, with guidance from the public health professional, shall select strategies to implement. In identifying these actions, prioritize those that are likely to have significant effects on health, are responsive to community concerns, and are feasible to implement given time and budget constraints. Teams should consider the extent to which the actions will address health impacts of higher concern as well as the feasibility of implementation and maintenance (in terms of cost, resources, technical constraints, etc.). Note that actions may include design changes as well as targeted programming for the property. Document which strategies were selected and determine how these strategies will be implemented throughout the project life cycle (e.g., who is responsible, when will they occur).

#### **Step 7. Create a Monitoring Plan [available for additional points]**

Develop a monitoring plan to determine how the health-promoting strategies that were implemented in the project are impacting resident/occupant health and wellness over time. Tailor the monitoring plan to the goals and capacity of the project team and partners. Consider involving residents in the monitoring process, including through data collection and analysis. Share the monitoring results with residents.



### **A. Define the goal for your monitoring plan**

- Align the goal of the monitoring plan with the desired impact of the Health Action Plan for the project team and impacted residents/occupants. For instance: Does the property [improve or reduce] [highest priority health issue for residents/occupants]?
- Also consider secondary goals to serve other purposes important to the project team and impacted occupants, such as informing grant funding, innovative partnerships with the health care sector, or future project design.

### **B. Select design, operations, and health performance metrics to track over time**

- Include design and operations metrics for each of the health promoting strategies selected as part of the Health Action Plan process
- Include health metrics to assess the property in general or for each health promoting strategy
- Include additional types of metrics as needed

### **C. Determine strategies of measurement (e.g., survey, monitoring frequency of use, building checklist) for each metric that align with the project team's capacity and capabilities**

### **D. Determine the frequency of assessment for each metric**

### **E. Define the staff, residents, or partners responsible for data collection, analysis, and dissemination.**

*Design metrics* are used to determine if and how well the selected health-promoting strategies were incorporated into the project design.

*Operations metrics* are used to determine if and how well property operations practices that impact the selected health-promoting strategies are implemented.

*Health metrics* are used to determine if and how well the health of residents/occupants is impacted by the selected health-promoting strategies. Health metrics may include frequency of use, changes in behavior, occupant perception, and, when possible, health outcomes (e.g., utilization or prevalence of symptoms).

Include the health metrics that make the most sense for your situation. Rather than creating health metrics of your own, you may choose to implement the Healthy Housing Outcomes Survey located in the Resources section of this criterion. Otherwise, connect directly with the public health professional to select metrics that will illustrate impact appropriate to the time frame of the monitoring plan.

## RECOMMENDATIONS

### STEPS 1–6: SAMPLE CHART

KEY HEALTH ISSUE AND POPULATION GROUP	POTENTIAL DESIGN, CONSTRUCTION, OR PROGRAMMING INTERVENTIONS	EXAMPLES OF STRATEGIES	WAS THIS STRATEGY ELECTED? (YES/NO)	IF SELECTED, INDICATE HOW THIS STRATEGY WILL BE IMPLEMENTED	RATIONALE FOR SELECTING OR REJECTING THE EXAMPLE STRATEGY
High incidence of childhood asthma	Eliminate or reduce use of materials with asthma triggers	No carpet	Yes	All floors will be hard surface flooring	Research demonstrates the health benefits of carpet-free housing. There is also a maintenance/ operations savings, which will be used to validate the extra cost up front.
Above-average prevalence of childhood obesity	Prioritize features that promote physical activity	Street infrastructure improvements to safely accommodate users of all ages, abilities, and transportation modes	No	N/A	Our project team does not have the capacity to affect local transportation infrastructure.
Above-average prevalence of childhood obesity	Prioritize features that promote physical activity	Design perimeter of building to allow kids to run, ride bikes, and walk the full perimeter of the building	Yes	Landscaping will include trample- proof groundcover and concrete walks	This feature will provide a local, safe space for the families living in our development to run. This will keep kids close to the building, which will be considered safer by families since it is within the yard.





**STEP 7: MONITORING**

INFORMATION IDENTIFIED IN STEPS 1–6			NEW COLUMNS ADDED IN STEP 7		
POPULATION NEED	SELECTED INTERVENTION(S)	SELECTED STRATEGY	POTENTIAL PERFORMANCE METRICS	RESPONSIBLE INDIVIDUAL(S) AND/OR ORGANIZATION(S)	FREQUENCY
<p><b>High incidence of childhood asthma</b></p>	<p>Eliminate or reduce use of potential asthmagens</p>	<p>No carpet flooring</p>	<p><b>Design Metrics:</b> No carpet is specified in the project plans and specs. All flooring materials specified are hard surfaces</p> <p><b>Operations Metrics:</b> Maintain flooring per manufacturer specifications. Measure IAQ in winter and summer</p> <p><b>Health Metrics:</b> Survey questions asking residents about the number of times that they or their child have used their emergency inhaler</p>	<p><b>Design Metrics:</b> Architect to certify that no carpet was utilized in the project design/specifications. John Smith, ACME Inc., 123.456.7890</p> <p><b>Operations Metrics:</b> Property manager will engage an IAQ consultant to measure formaldehyde levels in air once each quarter. Jane Doe, Co. Inc., 234.456.5678</p> <p><b>Health Metrics:</b> Residents will be surveyed by resident services team</p>	<p><b>Design Metrics:</b> To be certified on final plan set before construction starts</p> <p><b>Operations Metrics:</b> To be bi-annually</p> <p><b>Health Metrics:</b> Annual survey</p>
<p><b>Above-average prevalence of childhood obesity</b></p>	<p>Prioritize physical activity-promoting features</p>	<p>Design perimeter of building to allow kids to run, ride bikes, and walk the full perimeter of the building</p>	<p><b>Design Metrics:</b> Landscape architect to certify specified area located on drawings</p> <p><b>Operations Metrics:</b> Monitor path for debris, snow, and disrepair</p> <p><b>Health Metrics:</b> Frequency of use and annual survey of residents about child safety concerns and self-reported frequency of use</p>	<p><b>Design Metrics:</b> Architect to certify that specs include appropriate lighting fixtures. John Smith, ACME Inc., 123.456.7890</p> <p><b>Operations Metrics:</b> Maintenance technician to walk path. Jane Doe, Co. Inc., 234.456.5678</p> <p><b>Health Metrics:</b> Residential Services Coordinator Beth Smith, 123.456.7890. Residents to be surveyed by residential services team</p>	<p><b>Design Metrics:</b> To be certified on final plan set before construction starts</p> <p><b>Operations Metrics:</b> Weekly</p> <p><b>Health Metrics:</b> Quarterly observation of use and annual survey</p>

## RESOURCES

### *Health Action Plan Resources*

- **Health Action Plan resource page.** An animated two-minute overview video of the Health Action Plan, template scope of work for public health professionals, Health Action Plan evaluation case studies, and more are included here. [www.enterprisecommunity.org/healthactionplan](http://www.enterprisecommunity.org/healthactionplan)
- **Enterprise Community Partners and Success Measures, Healthy Housing Outcomes Survey.** Developed to enable affordable housing owners to measure changes in resident health outcomes most likely to be influenced by healthy housing development. [www.enterprisecommunity.org/resources/healthy-housing-outcomes-survey-7999](http://www.enterprisecommunity.org/resources/healthy-housing-outcomes-survey-7999)

### *Neighborhood- or Community-Level Health Data Sets (most relevant for Step 3)*

- **Most not-for-profit hospitals are required to perform a community health needs assessment (CHNA) as part of the IRS regulations allowing them tax-exempt status. As part of the data review, we encourage you to pull the CHNA(s) from the local hospital(s) as an additional data resource.**
- **Enterprise Community Partners, Opportunity360 Toolkit.** Includes a Measure tool that provides census-tract-level data on key community opportunity outcomes. The Listen tool offers resources to generate community feedback and participation. [www.opportunity360.org](http://www.opportunity360.org)
- **Centers for Disease Control and Prevention, 500 Cities: Local Data for Better Health.** Data at the city and census-tract level. [www.cdc.gov/500cities/index.htm](http://www.cdc.gov/500cities/index.htm)
- **Centers for Disease Control and Prevention, Creating a Health Profile of Your Neighborhood.** Project teams can consult this document for guidance. It outlines the basic steps and provides online resources for creating a neighborhood health profile. [www.cdc.gov/healthyplaces/toolkit/sources\\_of\\_health\\_data.pdf](http://www.cdc.gov/healthyplaces/toolkit/sources_of_health_data.pdf)
- **Community Commons.** This is an interactive mapping, data, and networking tool to support organizations in their efforts to create healthy, sustainable, and equitable communities. [www.communitycommons.org](http://www.communitycommons.org)
- **County Health Rankings.** The County Health Rankings use county-level measures from a variety of state and national data sources to assess and rank the population health of nearly all counties in the U.S. This website allows users to view the rankings and to explore and download data, including statistics on length of life, self-reported general health, and a subset of health influences. [www.countyhealthrankings.org](http://www.countyhealthrankings.org)
- **University of Kansas, Work Group for Community Health and Development, “The Community Toolbox” Best Change Processes.** [ctb.ku.edu/en/best-change-processes](http://ctb.ku.edu/en/best-change-processes)
- **Robert Wood Johnson Foundation, DataHub.** This website allows users to customize state-level data on key health and health care topics and visualize facts and figures. [www.rwjf.org/en/research-publications/research-features/rwjf-datahub.html](http://www.rwjf.org/en/research-publications/research-features/rwjf-datahub.html)
- **Centers for Disease Control and Prevention, Health Statistics You Can Visualize, Customize & Share.** This website provides links to health and environmental data from 23 states and one city. [ephtracking.cdc.gov/showStateTracking.action](http://ephtracking.cdc.gov/showStateTracking.action)
- **Centers for Disease Control and Prevention, Behavioral Risk Factor Surveillance System.** This is an annual, state-by-state phone survey of self-reported health outcomes used to determine national and state disease rates. [www.cdc.gov/brfss/](http://www.cdc.gov/brfss/)

### ***Stakeholder Engagement (most relevant for Step 4)***

- **HIA Society. Guidance and Best Practices for Stakeholder Participation in Health Impact Assessments.** [hiasociety.org/resources/Documents/guide-for-stakeholder-participation.pdf](https://hiasociety.org/resources/Documents/guide-for-stakeholder-participation.pdf)
- **Society of Practitioners of the Health Impact Assessment.** Stakeholder Engagement Tools and Materials. [hiasociety.org/Stakeholder-Engagement-Tools-&-Materials](https://hiasociety.org/Stakeholder-Engagement-Tools-&-Materials)

### ***Healthy Design References***

- **Health Impact Project's cross-sector toolkit for health.** This toolkit offers a collection of health impact assessments, guides, and other research to support policymakers' and practitioners' efforts to consider health when making decisions across sectors, such as housing, planning, and education. An accompanying data interactive allows users to explore data on completed and in-progress health impact assessments (HIAs) in the U.S. [www.pewtrusts.org/healthimpactproject/toolkit](http://www.pewtrusts.org/healthimpactproject/toolkit)
- **Build Healthy Places Network Jargon Buster and MeasureUp tools** may be particularly useful in the context of Health Action Plans. [buildhealthyplaces.org/](https://buildhealthyplaces.org/)
- **Promoting Equity through the Practice of HIAs.** This document highlights strategies for and case examples of promoting equity through HIAs. [hiasociety.org/resources/Documents/HIA-Promoting-Equity.pdf](https://hiasociety.org/resources/Documents/HIA-Promoting-Equity.pdf)
- **Human Impact Partners.** [humanimpact.org/products-resources/issue-area/?filter=iss1-141](https://humanimpact.org/products-resources/issue-area/?filter=iss1-141)

Some suggested tools and resources for your use are:

- **Roles for Collaborators.** This document provides examples of different partners that might be involved in a HIAs and their roles.
- **Rapid HIA Model.** This document provides guidance for conducting a HIA within a short timeline, while maintaining a high level of stakeholder engagement.
- **Data Sources Table.** This table outlines data sources that may be useful in a Health Impact Assessment.
- **Enterprise Green Communities: Aging-in-Place Design Guidelines.** [www.enterprisecommunity.org/resources/aging-place-design-guidelines-18245](https://www.enterprisecommunity.org/resources/aging-place-design-guidelines-18245)
- **National Network of Public Health Institutes: Community Health Improvement.** This website provides webinars, case studies, and resources regarding community health assessments and community health improvement tools and techniques. [www.nnphi.org/program-areas/community-health-improvement](https://www.nnphi.org/program-areas/community-health-improvement)
- **Centers for Disease Control and Prevention, Guide to Community Preventive Services.** This guide summarizes evidence of community-level programs and policies to improve health and prevent disease based on a scientific systematic review process. [www.thecommunityguide.org/](https://www.thecommunityguide.org/)

# 1.6

## OPTIONAL 10 POINTS

# RESILIENT COMMUNITIES: MULTI-HAZARD RISK/VULNERABILITY ASSESSMENT

### RATIONALE

The implications of climate change extend beyond disasters (shocks) to gradual changes (stressors, for example: chronic flooding and more frequent extreme heat days) that put vulnerable communities at an ever-increasing risk. We live in a world that has already warmed 1 degree Celsius (1.8 degrees Fahrenheit) over pre-industrial levels. Science finds that higher temperatures are causing a range of worsening impacts and damages. Low-income communities are on the front lines of a changing climate and often have the least access to resources needed to recover from a disaster. With the increasing frequency of storms, floods, and other extreme weather events, the costs associated with not investing in resilience are rising rapidly. Investing in resilience before disaster strikes is one of the most cost-effective ways to protect residents, citizens and property while strengthening their ability to weather the increasingly severe storms ahead.

Creating building and housing projects that will perform well during disasters also protects against the gradual changes to the environment we are experiencing. But developing such projects requires careful planning. The exercise of assessing vulnerabilities and creating a plan to mitigate appropriate risks will result in greater focus on this issue. Engaging in this exercise during the integrative design process will yield input from a variety of stakeholders and help you to incorporate measures that enhance resilience throughout the project design and construction documents.

### REQUIREMENTS

Conduct a four-part assessment (social, physical, functional, strategy) to identify critical risk factors of your property and implement at least two sets of strategies to enable the project to adapt to, and mitigate, climate-related or seismic risks.

Your Multi-Hazard Risk/Vulnerabilities Assessment must:

- Prioritize a deeper evaluation of applicable hazards (e.g., wildfires, flooding, seismic) identified in the state or county hazard mitigation plan for which your project is located.
- Identify strategies that will be implemented that address, at least, the top three risk factors identified for your project.
- Ensure that these implemented strategies that have been included in the project are referenced, documented, and explained in Criterion 8.2.

Note: Criterion 1.1 requires project teams to create a generic evaluation of Climate and Environmental Resilience issues in Section 6 of the Project Priorities Survey. To earn optional points under Criterion 1.6, project teams must complete the above requirements.

## RECOMMENDATIONS

- Hold a series of facilitated charrettes and community meetings focused explicitly on identifying how the issues identified in your project's state or county hazard mitigation plan apply to your project and those residing in, working in, visiting or served by your project.
- Based on your multi-hazard/vulnerabilities assessment, identify solutions appropriate for your project, evaluate how these strategies overlap with the other criteria selected for your project and determine the best means of implementation. Strategies should be appropriate to the unique residency/users of your building. For example, seniors-only buildings may have different needs from buildings that serve primarily family populations. Also consider and prioritize social and cultural needs your project users may identify.
- Creating a safe and comfortable centralized location where residents and community members can share resources (e.g., water, food, electrical outlets) and disseminate relevant emergency information from building management is important when considering the immediate moments after an acute disruption. We also know that, during a disruption, residents/occupants tend to lean on their neighbors/co-workers for support. Creating a safe, centralized location facilitates stronger social resilience within the community.
- Enterprise's Multifamily Resilience Manual includes more than a dozen strategies and specific guidance for building property resilience in the event of an emergency. Consider incorporating one or more of these measures into your property.

## RESOURCES

- The Federal Emergency Management Agency's hazard mitigation planning resources include a Mitigation Planning Handbook, guidelines for Sustainability in Mitigation Planning, Planning Advisory Service Reports, and examples of Mitigation Activities. [www.fema.gov/hazard-mitigation-planning-resources](http://www.fema.gov/hazard-mitigation-planning-resources)
- The National Hazard Mitigation Association (NHMA). Promotes natural hazard risk reduction and climate adaptation through planning, adaptation, and mitigation. The NHMA promotes steps to reduce the risk and consequences of natural events with a special emphasis on protecting the most vulnerable populations in our communities. [nhma.info](http://nhma.info)
- The Built Environment Coalition (BEC). Develops analytical approaches, methodologies, and tools to help communities and organizations identify opportunities to improve their built environment and make informed decisions on potential investments. [www.builtenvironmentcoalition.org](http://www.builtenvironmentcoalition.org)
- The Federal Alliance for Safe Homes (FLASH). The country's leading consumer advocate for strengthening homes and safeguarding families from natural and manmade disasters. [www.flash.org](http://www.flash.org)
- Metropolitan Washington Council of Government, Climate Adaptation Planning Initiatives Report. [www.mwcog.org/uploads/pub-documents/pl5cXls20130701111432.pdf](http://www.mwcog.org/uploads/pub-documents/pl5cXls20130701111432.pdf)
- American Institute of Architects, Climate Change Adaptation Design Resources. [www.aia.org/pages/77741-design-resources-for-climate-change-adaptati](http://www.aia.org/pages/77741-design-resources-for-climate-change-adaptati)
- The Federal Emergency Management Agency's Building Vulnerability Assessment Checklist may be used as a screening tool for preliminary design vulnerability assessment. [www.fema.gov/media-library-data/20130726-1524-20490-4937/fema452\\_a.pdf](http://www.fema.gov/media-library-data/20130726-1524-20490-4937/fema452_a.pdf)
- Kaiser Permanente Hazard and Vulnerability Assessment Tool, Naturally Occurring Events. A sample Hazard Vulnerability Analysis Tool. [cchealth.org/ems/pdf/Kaiser-HVA-Tool-and-Instructions.pdf](http://cchealth.org/ems/pdf/Kaiser-HVA-Tool-and-Instructions.pdf)



- 
- California Association of Health Facilities, Hazard Vulnerability Worksheet. This may be used as a template to score and assess your project for potential mitigative actions that can reduce identified vulnerabilities. [www.calhospitalprepare.org/hazard-vulnerability-analysis](http://www.calhospitalprepare.org/hazard-vulnerability-analysis)
  - Green Building and Climate Resilience, Understanding Impacts and Preparing for Changing Conditions, University of Michigan; U.S. Green Building Council, 2011. This document identifies climate-related vulnerabilities at the regional level and prioritizes design, construction, and operation strategies that will increase resilience and facilitate climate adaptation. [www.usgbc.org/Docs/Archive/General/Docs18496.pdf](http://www.usgbc.org/Docs/Archive/General/Docs18496.pdf)
  - Enterprise Community Partners, Multifamily Resilience Manual. [www.enterprisecommunity.org/news-and-events/news-releases/multifamily-building-resilience-manual](http://www.enterprisecommunity.org/news-and-events/news-releases/multifamily-building-resilience-manual)
  - Department of Energy & Environment maintains resources on local climate projections and tools for adaptation and preparedness ([doee.dc.gov/climateready](http://doee.dc.gov/climateready)). In particular, the Resilience Opportunity Assessment Tool can help you evaluate opportunities for resilience and feasibility of solar photovoltaics for your multifamily property.
  - Urban Green, Building Resiliency Task Force Full Report, June 2013. This report provides resiliency-related recommendations for communities and buildings. [issuu.com/urbangreen/docs/btrf\\_full\\_report](http://issuu.com/urbangreen/docs/btrf_full_report)
  - Enterprise Green Communities, Ready to Respond Toolkit helps project teams complete Criterion 1.6 and provides further guidance on developing comprehensive plans to protect buildings, ensure continuity of service and engage residents/occupants on disaster preparedness. [www.enterprisecommunity.org/resources/ready-respond-strategies-multifamily-building-resilience-13356](http://www.enterprisecommunity.org/resources/ready-respond-strategies-multifamily-building-resilience-13356)

# 1.7

## **OPTIONAL** *8 POINTS*

# RESILIENT COMMUNITIES: STRENGTHENING CULTURAL RESILIENCE

### **RATIONALE**

Resident participation, cultural leadership, and community buy-in will help ensure a successful project. An inclusive process enables the project to be more reflective of community needs and benefits.

Investing in trust building with the community can also mitigate community objection and create momentum for future development processes. This will save time and resources throughout project development and once the building is in operation.

Projects that have intentionally used a more inclusive and culturally relevant development process have benefited from quicker approvals as well as lower holding costs, vacancy rates, resident/tenant turnover and unit rollover costs for owners. These projects benefit from increased sense of shared ownership over public spaces, social accountability for upkeep and safety, and sense of belonging for residents, tenants, and visitors.

An inclusive process enables the project to be more reflective of community needs and can yield the following benefits:

- Increase the financial viability and sustainability of your project.
- Build goodwill between the community and developer, mitigating community objection and creating momentum for future development processes.
- Reduce antagonism in the development process and streamline decision-making, which saves times and money and increases interest from potential occupants.
- Shift the paradigm of inequity that has determined how investments get made in communities.
- Reverse the trend of displacing residents and small businesses, which has contributed to loss of community cohesion and further gentrification and inequity.

This criterion provides guidance for developers to integrate community and building user participation in development processes so that the built environment honors cultural identities, resident voices, and community histories. This is intended to contribute to an increase in social cohesion, health, and equity for residents, tenants, and facility users.



## REQUIREMENTS

Strengthen cultural resilience through one of the options below.

### Option 1: Complete a Cultural Resilience Assessment

With residents/facility users, identify community needs and assets. Complete the Cultural Resilience Assessment worksheet as you take the following actions:

- Listen to community identified needs, assets, priorities, and insights as core inputs for the project mission.
- Ground-truth any existing data or plans with community to gain more local insight and perspective from people's lived experience and knowledge.
- Identify factors in this project that may produce and perpetuate racial inequities. Determine what adverse impacts or unintended consequences could result from this project, which racial/ethnic groups could be negatively affected, and how adverse impacts could be prevented or minimized.
- Share how these outputs impacted the project goals and strategies.

OR

### Option 2: Convene a Cultural Advisory Group

Convene and consult on a regular basis with a cultural advisory group. The advisory group must include local artists and culture bearers who give input on a range of decisions and guide the design and development team in the community planning process, ensuring the creation of spaces that are unique, reflective of resident/local cultures and representative of community values. As you convene your stakeholders, complete the Cultural Advisory Group Charter template, which specifies how to:

- Define the group's purpose, responsibilities, expectations, and incentives for participation.
- Create a process for inviting and selecting advisory group members that prioritizes a diverse range of interests, knowledge, and experience, including age, roles, and relationship to targeted resident community.
- Determine the parameters, practices, and terms with and for the cultural advisory group members' role and service in this capacity.
- Establish a process for ensuring that the advisory group's input translates into project-specific goals and decisions.

## RECOMMENDATIONS

Because equitable outcomes are a top priority, it is essential to be sensitive to those individuals/community members the project team is not hearing from and make sure they have a voice in the process.

It is critical that community residents see the development as an asset and something worth investing in, and that developers see residents as experts who know what they need. Engage residents early, and regularly thereafter, in setting priorities. Be clear about project constraints and opportunities.

Residents/targeted users of the project should be understood as community experts.

- Invite interested residents/project users to form an advisory group or small community leadership committee to regularly advise the project and include community perspective and values and to liaise and communicate between developer and project users.



- Determine a form of compensation or stipend for community leadership roles.
- Include the property staff and services coordinators in the design/goal setting.
- Give all individuals involved the ability to have a voice in the process.
- Create a space that allows participation from all in a way that elevates the voices of those less able or less heard.
- Spend time in the community prior to a large community meeting or set up individual time to meet with and hear input from community members, or to conduct one-on-one interviews and focus groups. This time could also be spent in small groups, using multiple forms of communication—verbal, written, drawn, etc.
- Input can be informal or documented, depending on what feels appropriate to the context, and if you have permission from the participants.
- Carve out staff time or hire a community outreach specialist with cultural competence to involve residents/project users and/or facilitate meetings.
- Go to where the people are.
- Messaging about the project should come from a trusted community liaison (CBO, block club, community group, cultural leader, local elected official, etc.).
- Get on the agenda of already scheduled community meetings or co-host a cultural event with a trusted community leader or organization to talk about the project ideas and collect initial feedback.
- Meet at a time and location that is convenient and accessible (typically weekday evenings or weekends) and provide a meal and childcare.

## RESOURCES

### Compilations of tools and resources

- PolicyLink, Creating Change through Arts, Culture, and Equitable Development. A policy and practice primer. [www.policylink.org/resources-tools/arts-culture-equitable-development](http://www.policylink.org/resources-tools/arts-culture-equitable-development)
- Enterprise Community Partners, Design Matters. [www.enterprisecommunity.org/solutions-and-innovation/design-leadership/designmatters](http://www.enterprisecommunity.org/solutions-and-innovation/design-leadership/designmatters)
- IDEO's field guide to human-centered design has some great tools within that could be adapted for this process. [www.designkit.org/resources/1](http://www.designkit.org/resources/1)
- Enterprise Community Partners, Made to Last. A field guide for community resilience that highlights five diverse community development organizations leveraging culture and creativity to strengthen community resilience. [www.enterprisecommunity.org/resources/made-last-field-guide-community-resilience-vol-1-8271](http://www.enterprisecommunity.org/resources/made-last-field-guide-community-resilience-vol-1-8271)
- National Endowment for the Arts, How to do Creative Placemaking. [www.arts.gov/publications/how-do-creative-placemaking](http://www.arts.gov/publications/how-do-creative-placemaking)

### Equitable Community Engagement

- Sustainable Infrastructure Scorecard—Equity and Social Justice Credits, King County, Washington. [kingcounty.gov/~media/depts/dnrp/solid-waste/green-building/documents/ESJ-credits-guidelines.ashx?la=en](http://kingcounty.gov/~media/depts/dnrp/solid-waste/green-building/documents/ESJ-credits-guidelines.ashx?la=en)
- Atlanta Community Engagement Playbook. [ourcommunity.is/engaged/](http://ourcommunity.is/engaged/)
- LISC: Authentic Community Engagement. [www.lisc.org/media/filer\\_public/d2/ea/d2ea81ee-0d8b-45e1-be55-0c1f17684e88/authentic\\_community\\_engagement\\_smart\\_suite\\_2016.pdf](http://www.lisc.org/media/filer_public/d2/ea/d2ea81ee-0d8b-45e1-be55-0c1f17684e88/authentic_community_engagement_smart_suite_2016.pdf)

# 1.8

## BASELINE FOR NEW CONSTRUCTION RESIDENTIAL. OPTIONAL FOR ALL OTHER PROJECTS. RESILIENT STRUCTURES

### RATIONALE

Establishing a safe room within a structure can provide protection to occupants from the dangers of tornadoes and extreme wind events.

### REQUIREMENTS

#### Baseline – New Construction Residential (without a basement)

Construct a safe room to protect against wind forces and wind debris from events such as a tornado. Follow the guidance in the applicable publication; Taking Shelter from the Storm: Building a Safe Room for Your Home or Small Business (FEMA 320) or Design and Construction Guidance for Community Shelters (FEMA 361).

#### Optional [10 points] – All Other Projects

Construct a safe room to protect against wind forces and wind debris from events such as a tornado. Follow the guidance in the applicable publication; Taking Shelter from the Storm: Building a Safe Room for Your Home or Small Business (FEMA 320) or Design and Construction Guidance for Community Shelters (FEMA 361).

“Home is everything.  
Home is a place where  
you can be yourself.  
Home is a place where  
you feel protected.”

Resident of Enterprise Green  
Communities property

### RECOMMENDATIONS

Work with local emergency management officials on project design and to identify potential safe room funding sources

### RESOURCES

- FEMA publication, Residential Safe Rooms: Background and Research.  
[www.fema.gov/emergency-managers/risk-management/safe-rooms/resources](http://www.fema.gov/emergency-managers/risk-management/safe-rooms/resources)
- FEMA Safe Rooms.  
[www.fema.gov/safe-rooms](http://www.fema.gov/safe-rooms)
- National Storm Shelter Association  
[nssa.cc/](http://nssa.cc/)
- FEMA publication, Tornado Protection: Selecting Refuge Area in Buildings.  
[www.fema.gov/media-library/assets/documents/2246?id=1563](http://www.fema.gov/media-library/assets/documents/2246?id=1563)

## LOCATION + NEIGHBORHOOD FABRIC

LOCATING THE PROJECT IN A NEIGHBORHOOD WITH EXISTING INFRASTRUCTURE, TRANSPORTATION AND SERVICES ENHANCES LIVABILITY, LEADS TO MORE RESOURCE-EFFICIENT DEVELOPMENT OF LAND, SAVES ENERGY, AND INCREASES THE VITALITY OF THE COMMUNITY.

### INTRODUCTION CRITERIA CHECKLIST

- 1 INTEGRATIVE DESIGN
- 2 LOCATION + NEIGHBORHOOD FABRIC
- 3 SITE IMPROVEMENT
- 4 WATER
- 5 OPERATING ENERGY
- 6 MATERIALS
- 7 HEALTHY LIVING ENVIRONMENT
- 8 OPERATIONS, MAINTENANCE + OCCUPANT ENGAGEMENT

### APPENDIX

## 2.1

# BASELINE SENSITIVE SITE PROTECTION

### RATIONALE

Protecting fragile and scarce environmental resources minimizes negative impacts on valuable ecosystems. Designating sensitive lands into Ecological Resource Protection Zones (ERPZs) and limiting development in these areas decreases the impact that development has on fragile ecosystems and reduces the risks of flooding due to climate change.

### REQUIREMENTS

All projects must:

1. **Protect floodplain functions** (e.g., storage, habitat, water quality) by limiting new development within the 100-year floodplain of all types of watercourses.
2. **Conserve and protect aquatic ecosystems**, including wetlands and deepwater habitats that provide critical ecosystem functions for fish, other wildlife, and people.
3. **Protect ecosystem function** by avoiding the development of areas that contain habitat for plant and animal species identified as threatened or endangered.
4. **Conserve the most productive agricultural soils** by protecting prime farmland, unique farmland, and farmland of statewide or local importance.

If your site contains any of these ecologically sensitive features (floodplains; aquatic ecosystems, including wetlands; habitat for threatened or endangered species; prime farmland), follow the Requirements under that subheading.

An ERPZ requires boundaries that are identified and mapped on site plan(s) during the pre-development phase. Areas that fall inside the perimeter of an ERPZ must be treated sensitively, as described throughout the Iowa Green Streets Criteria, to ensure that there is no disturbance, disruption, or damage of: 1) floodplains; 2) aquatic ecosystems, 3) wildlife habitats; and 4) prime farmland. Not every development will have an ERPZ. A development that has an ERPZ will not necessarily have each of the four ERPZ types represented.

## ERPZ DOCUMENTATION SAMPLE

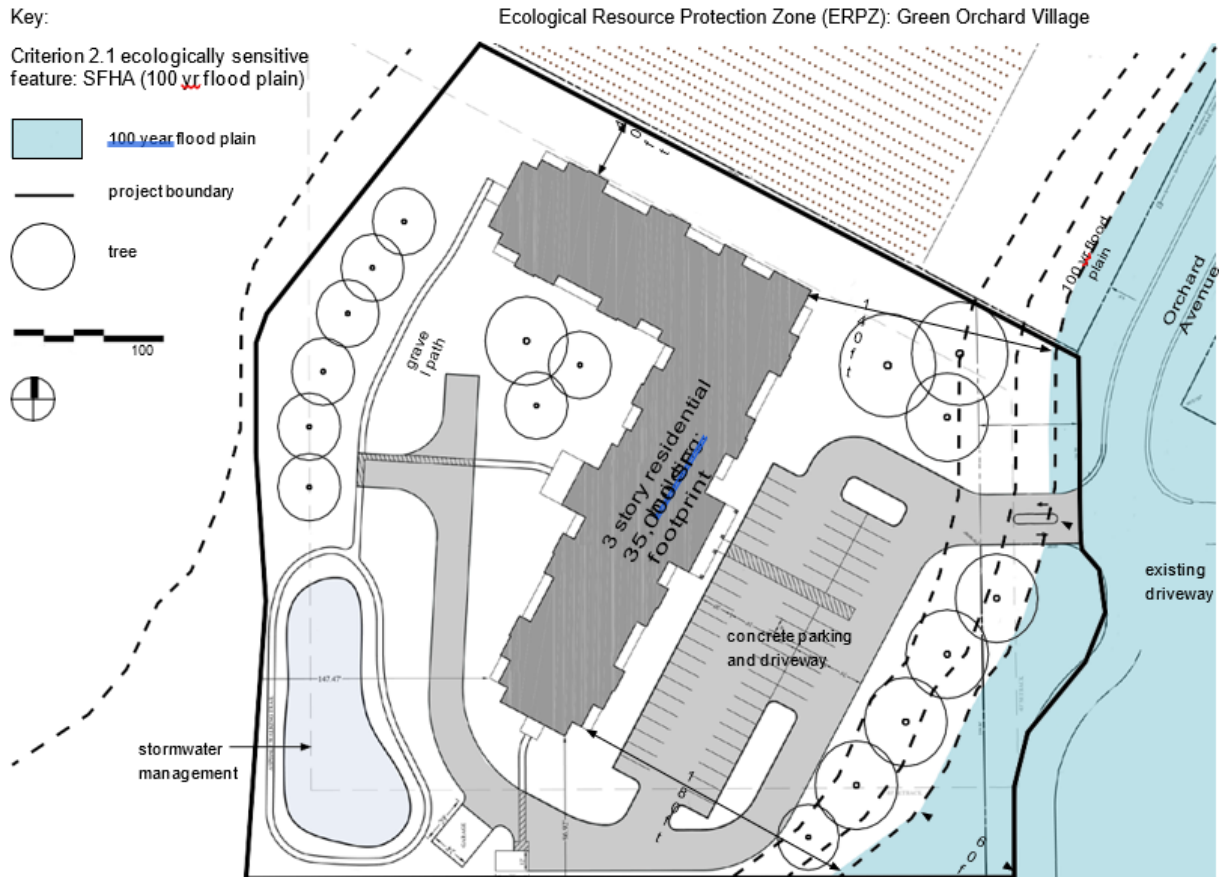

### 1. Protect floodplain functions

Protect floodplain functions (e.g., storage, habitat, water quality) by limiting new development within the 100-year floodplain of all types of watercourses. To determine if you're in a Special Flood Hazard Area (SFHA), refer to the FEMA Flood Map Center (<https://msc.fema.gov/portal/home>) or other local/state agency, as appropriate.

All projects must document the location of the 100-year floodplain as identified by FEMA on the Flood Insurance Rate Map (FIRM) as part of an ERPZ. See sample ERPZ documentation above:

#### New Construction – Minimize development in floodplains:

- Do not develop on a site that contains any SFHA as identified by FEMA on the FIRM, or local/state entity as appropriate.

#### Rehabilitation – Maintain or improve existing floodplain conditions:

- Projects built on land that is within the SFHA as identified by FEMA on the FIRM, must be designed to meet the ASCE 24 Flood Resistant Design and Construction standard.
- Ensure that any development or redevelopment activities within the floodplain will mitigate and improve existing floodplain conditions (maintain or increase existing floodplain storage, improve water quality, implement flood-resilient design).
- Do not raise topographical elevations in flood zones.

## 2. *Protect aquatic ecosystems*

All projects must document the full geographic extent of any aquatic ecosystems, including isolated wetlands, located within the project boundary as part of an ERPZ. (See sample ERPZ documentation on previous page.)

Aquatic ecosystems include wetlands and deepwater habitats, and are classified as:

- Marine (tidal wetlands, shorelines, mudflats, reefs)
- Estuarine (bays, lagoons, marshes)
- Riverine (streams, rivers [associated floodplains and their riparian buffer])
- Lacustrine (lakes, ponds [associated shorelines and their riparian buffer])
- Palustrine (non-tidal wetlands, seeps, springs, vernal pools, seasonal wetlands)

Identifying and delineating aquatic ecosystems is detailed by the U.S. Army Corps of Engineers. Other boundaries of aquatic ecosystems are defined by ordinary high-water mark (OHWM).

**New Construction.** Do not build within 100 feet of any of the wetlands or deepwater habitats identified in the ERPZ.

**Rehabilitation.** Maintain or improve existing aquatic ecosystems:

- Do not extend the building, built structures, roads, or parking areas into the ERPZ, beyond where they already exist.
- Develop restoration plans for wetland and deepwater habitats within the ERPZ.

## 3. *Conserve habitat for any species on federal or state threatened or endangered lists*

As part of the pre-development design process, identify whether the site is in the range of habitats for any plant or animal species on U.S. federal or state threatened or endangered lists. If the site hosts any threatened or endangered plant or animal species, conduct a habitat assessment for each identified species.

**All Projects.** Sites that feature habitats for any species on federal or state threatened or endangered lists must:

- Designate the full extent of habitats for threatened and endangered plant and animal species on the site as an ERPZ and do not extend the building, built structures, roads, or parking areas into the ERPZ. (See sample ERPZ documentation on previous page.)
- Minimize disturbances within the ERPZ during construction. If construction activities permanently disrupt the habitat of threatened or endangered animal habitats, follow the guidance of responsible state (or local) agencies on how to best address.

#### 4. Limit development on farmland (only for New Construction projects)

Prime farmland is defined by the U.S. Department of Agriculture (USDA) in the United States Code of Federal Regulations, Title 7, Volume 6, Parts 400–699, Section 657.5 or by the USDA's Natural Resources Conservation Service (NRCS) soil survey.

If farmland soils are present on-site, consider relocating the project to an alternative site. If developing on an alternative site is not possible:

- Designate the full extent of prime farmland soils on the site as an ERPZ (see sample ERPZ documentation above). Minimize development and disturbance of prime farmland. Note the percentage of prime farmland that is developed.
- If more than 20% of the prime farmland noted in the ERPZ is developed, the project must purchase a permanent agricultural conservation easement on land with comparable, productive farmland soils for every acre of prime farmland developed, 1:1.

### RECOMMENDATIONS

- Operations and Maintenance plans (Criterion 8.1) should include section(s) describing ongoing management activities required to protect the integrity of the floodplain functions.
- Many states have specific protocols for evaluating sites for endangered animals and plants. Be sure to consult with your state (or local) codes or other requirements when evaluating the wildlife habitats on your site.
- When endangered animal species are present on-site, make efforts to commence construction and maintenance activities during seasons when the animal species are not present.

### RESOURCES

- U.S. Departments of Homeland Security, FEMA Flood Map Service Center. <https://msc.fema.gov/portal/home>
- U.S. Army Corps of Engineers, Regional Supplements to Corps Delineation Manual. [www.usace.army.mil/Missions/Civil-Works/Regulatory-Program-and-Permits/reg\\_supp/](http://www.usace.army.mil/Missions/Civil-Works/Regulatory-Program-and-Permits/reg_supp/)
- U.S. Department of Agriculture, Natural Resources Conservation Service—Soil Survey. [www.nrcs.usda.gov/wps/portal/nrcs/detailfull/soils/survey/?cid=nrcs142p2\\_053369](http://www.nrcs.usda.gov/wps/portal/nrcs/detailfull/soils/survey/?cid=nrcs142p2_053369)
- U.S. Department of Agriculture, Wetland Restoration, Enhancement, and Management (2003). [www.nrcs.usda.gov/Internet/FSE\\_DOCUMENTS/nrcs143\\_010838.pdf](http://www.nrcs.usda.gov/Internet/FSE_DOCUMENTS/nrcs143_010838.pdf)
- U.S. Department of the Interior, Fish and Wildlife Service—Endangered Species (plants and animals): [www.fws.gov/endangered/](http://www.fws.gov/endangered/).  
For an interactive online map of critical habitat for threatened and endangered species: [fws.maps.arcgis.com/home/webmap/viewer.html?webmap=9d8de5e265ad4\\_fe09893cf75b8dbfb77](http://fws.maps.arcgis.com/home/webmap/viewer.html?webmap=9d8de5e265ad4_fe09893cf75b8dbfb77)
- U.S. Department of Agriculture, A Technical Guide for Monitoring Wildlife Habitat (2013). [www.fs.fed.us/research/publications/gtr/gtr\\_wo89/gtr\\_wo89.pdf](http://www.fs.fed.us/research/publications/gtr/gtr_wo89/gtr_wo89.pdf)
- Federal Geographic Data Committee, Classification of Wetlands and Deepwater Habitats of the United States. [www.fgdc.gov/standards/projects/wetlands/nwcs-2013](http://www.fgdc.gov/standards/projects/wetlands/nwcs-2013)
- Farmland Information Center. [www.farmlandinfo.org](http://www.farmlandinfo.org)
- American Farmland Trust. [farmland.org](http://farmland.org)

## 2.2

# BASELINE FOR NEW CONSTRUCTION CONNECTIONS TO EXISTING DEVELOPMENT AND INFRASTRUCTURE

### RATIONALE

Locating a project within an existing neighborhood and in proximity to existing infrastructure encourages more resource-efficient development of land, conserves energy, adds to the vitality of the overall community, and safeguards a community during significant weather events. Ensuring that pedestrian and cycling infrastructure is included encourages safe, active transportation, which can improve health by increasing daily physical activity.

### REQUIREMENTS

- Locate the project on a site that is within or contiguous to existing development (at least 25% of the site perimeter borders currently developed land) and that has access to existing road, water, and sewers infrastructure.
- Connect the project to the existing pedestrian network by creating new roads with sidewalks, providing sidewalks on existing streets, or providing all-weather pathways to link the project to transit stops, public or civic spaces, open spaces, and adjacent development.
- For sites over 5 acres, provide connections to the adjacent street network at least every 800 linear feet along site perimeter.
- Tie all planned bike paths/lanes on your site to existing bike paths or lanes that intersect your site in ways that are safe, accessible, and clearly identified.

### RECOMMENDATIONS

- Provide enhanced pedestrian crossings at intersections using elements such as curb extensions, medians, crosswalk count-down clocks, daylighting, detectable warning strips, street treatments (e.g., different color or texture pavement in crosswalks), or sidewalk expansion. On streets with large blocks, consider mid-block pedestrian crossings.
- Dedicated pedestrian and bicycle paths are important even on dead-end streets.
- If bicycle lanes or paths run through or adjacent to your site, consider adding bicycle storage for residents and visitors.
- Design engaging and safe sidewalk experiences appropriate for expected pedestrian flows and uses. Include benches and shade trees for rest and shade.



---

## RESOURCES

- Task Force on Community Preventive Services, The Community Guide—What Works to Promote Health. [www.thecommunityguide.org/](http://www.thecommunityguide.org/)
- Center for Active Design, Active Design Guidelines. Includes a chapter on urban design (Chapter 2) highlighting best practices for sidewalk design to encourage their vibrant use, including features like trees, lighting, and wayfinding. [centerforactivedesign.org/guidelines/](http://centerforactivedesign.org/guidelines/)
- Center for Active Design, Healthy Housing for All. [centerforactivedesign.org/healthy-housing-for-all](http://centerforactivedesign.org/healthy-housing-for-all)
- NYC Department of Health and Mental Hygiene, Active Design Supplement: Shaping the Sidewalk Experience (2013). [www1.nyc.gov/assets/doh/downloads/pdf/environmental/sidewalks-experience.pdf](http://www1.nyc.gov/assets/doh/downloads/pdf/environmental/sidewalks-experience.pdf)
- NYC Department of Health and Mental Hygiene. Active Design Supplement: Active Design Promoting Safety (2013). [www1.nyc.gov/assets/doh/downloads/pdf/environmental/promoting-safety.pdf](http://www1.nyc.gov/assets/doh/downloads/pdf/environmental/promoting-safety.pdf)
- The Community Preventive Services Task Force. Environmental and Policy Approaches to Increase Physical Activity, Street-Scale Urban Design Land Use Policies. [www.thecommunityguide.org/findings/physical-activity-built-environment-approaches](http://www.thecommunityguide.org/findings/physical-activity-built-environment-approaches)
- Smart Growth America, Complete Streets. [www.smartgrowthamerica.org/complete-streets](http://www.smartgrowthamerica.org/complete-streets)
- Resilient City Urban Design Principles. A resilient post-carbon community, which reorients city-life to the pedestrian scale (a 500-mile radius), must focus its efforts on creating several local destinations, which attract a critical mass of users and activities. [www.resilientcity.org/index.cfm?id=11928](http://www.resilientcity.org/index.cfm?id=11928)

## 2.3

# BASELINE FOR NEW CONSTRUCTION COMPACT DEVELOPMENT

## RATIONALE

Compact development encourages more resource-efficient development of land, conserves energy and supports demand for transit, neighborhood retail and community cohesion. Compact development also correlates with walking behavior and physical activity through active transportation. For communities that want to promote active transportation and a healthy lifestyle, compact development is critical to success.

## REQUIREMENTS

### *FOR RESIDENTIAL PROJECTS*

At a minimum, build to the residential density (dwelling units/acre) of the census block group where the project is located. Find the density of your census block group by typing your project address into the Center for Neighborhood Technology “Residential Density of a Location” calculator found at [apps.cnt.org/residential-density](https://apps.cnt.org/residential-density).

In Rural/Tribal/Small Town locations that do not have zoning requirements: Build to a minimum net density of 5 units per acre for single-family houses; 10 units per acre for multifamily buildings, single and two-story; and 15 units per acre for multifamily buildings greater than two stories.

Notes:

- Net density calculations do not include land that is set aside for future building phases or development. For multi-phased projects, the project net density should include only the portion of the parcel that is being used for that particular phase.
- Any acreage maintained as permanently protected open space per Criteria 2.6 and 2.7 may be deducted from total project acreage to determine project density.

### *FOR COMMERCIAL PROJECTS*

The Project architect or designer must complete the density calculation as defined below and certify its correctness. The project applicant must provide documentation from the applicable local jurisdiction indicating that the applicable density requirements provided below are permitted on the project site. The minimum floor-area ratio (FAR) for new construction must be 0.5. The floor-area ratio (FAR) is the density of nonresidential land use, exclusive of parking, measured as the total nonresidential building floor area divided by the total buildable land area available for nonresidential structures. For example, on a site with 10,000 square feet of buildable land area, a FAR of .5 would be 5,000 square feet of building floor area. On the same site, a FAR of 1.5 would be 15,000 square feet.

### *FOR MIXED USE PROJECTS WITH COMMERCIAL AND RESIDENTIAL*

Mixed use projects containing both residential and non-residential uses may choose either density option above.

---

## RECOMMENDATIONS

To determine if your project qualifies as Rural/Tribal/Small Town, reference the definitions included in the Appendix J.

## RESOURCES

- Congress for the New Urbanism. This nonprofit organization provides tools and resources for promoting walkable, neighborhood-based development as an alternative to sprawl. [www.cnu.org](http://www.cnu.org)
- Smart Growth America. This website outlines smart growth principles, provides a guide through smart growth terms and technical concepts, and hosts a searchable catalogue of reports, websites, tools, and case studies. [smartgrowthamerica.org/](http://smartgrowthamerica.org/)
- Resilient City Urban Design Principles. A resilient post-carbon community, which reorients city life to the pedestrian scale (a 500-mile radius), must focus its efforts on creating several local destinations, which attract a critical mass of users and activities. [www.resilientcity.org/index.cfm?id=11928](http://www.resilientcity.org/index.cfm?id=11928)
- Urban Land Institute. This nonprofit organization promotes the responsible use of land to enhance the total environment. ULI's online bookstore includes numerous publications regarding compact and higher-density development. [www.uli.org](http://www.uli.org)

## 2.4

### OPTIONAL 5 OR 7 POINTS

## INCREASED COMPACT DEVELOPMENT

### RATIONALE

Compact development encourages more resource-efficient development of land, conserves energy and supports demand for transit, neighborhood retail, and community cohesion. See Rationale for Criterion 2.3.

### REQUIREMENTS

#### FOR RESIDENTIAL PROJECTS

Exceed the residential density (dwelling units/acre) of the census block group in which your project is located. Find the density of your census block group by typing your project address into the Center for Neighborhood Technology “Residential Density of a Location” calculator found at [apps.cnt.org/residential-density/](https://apps.cnt.org/residential-density/).

In Rural/Tribal/Small Towns that do not have zoning requirements, build to a minimum net density of 7.5 units per acre for single-family houses; 12 units per acre for multifamily buildings, single and two-story; and 20 units per acre for multifamily buildings greater than two stories. *[5 points]*

EXCEED THE CNT RESIDENTIAL DENSITY	OPTIONAL POINTS
2x	5 points
3x	7 points

#### FOR COMMERCIAL PROJECTS

The Project architect or designer must complete the density calculation as defined below and certify its correctness. The project applicant must provide documentation from the applicable local jurisdiction indicating that the applicable density requirements provided below are permitted on the project site. The minimum floor-area ratio (FAR) for new construction must be 0.8.

#### FOR MIXED USE PROJECTS WITH COMMERCIAL AND RESIDENTIAL

Mixed use projects containing both residential and non-residential uses may choose either density option above.

### RECOMMENDATIONS

See Recommendations for Criterion 2.3.

### RESOURCES

See Resources for Criterion 2.3.

# 2.5

## BASELINE FOR NEW CONSTRUCTION PROXIMITY TO SERVICES AND COMMUNITY RESOURCES

### RATIONALE

Locating housing in proximity to neighborhood services, including grocery stores, community centers, health services, and some retail shops, reduces the need to travel, thus reducing monthly living costs and improving health by encouraging walking or biking. Additionally, proximity and access to active recreation facilities such as parks, playgrounds, and other exercise amenities are associated with increased physical activity and contribute to a healthy lifestyle.

Residents, occupants and project users with services within a close, safe, accessible physical proximity will fare better during natural disasters in the event of a loss of automobile access or other major events when gasoline and public transportation may be limited.

### REQUIREMENTS

Demonstrate that your project is within a 0.5-mile walk distance of at least four, or a 1-mile walk distance of at least seven, resources identified below.

Each “service” type may not be counted more than twice. For example, if there are five banks within the required distance, only two may be counted.

#### SERVICES AND COMMUNITY RESOURCES

FOOD ACCESS	HEALTH & WELLNESS	EDUCATION & CULTURE	MOBILITY	CIVIC & COMMUNITY FACILITIES	RETAIL	SERVICES
<ul style="list-style-type: none"> <li>· Farmers market</li> <li>· Full-service grocery store</li> <li>· Other food store with produce</li> <li>· Restaurant, café, diner</li> </ul>	<ul style="list-style-type: none"> <li>· Pharmacy</li> <li>· Medical clinic or office that treats patients</li> <li>· Gym, health club, exercise studio</li> <li>· Public pool</li> <li>· Skating rink</li> <li>· Sport court/field</li> <li>· Public park</li> </ul>	<ul style="list-style-type: none"> <li>· Public library</li> <li>· Place of worship</li> <li>· Educational facility (including K–12 school, university, adult education center, vocational school, community college)</li> <li>· Cultural arts facility (e.g., museum, performing arts space, concert venue)</li> </ul>	<ul style="list-style-type: none"> <li>· Public transportation (e.g., bus stop, ride share, on-call transit)</li> <li>· Bike share/scooter docking station</li> </ul>	<ul style="list-style-type: none"> <li>· Community or recreation center, potentially including performance space</li> <li>· Police or fire station</li> <li>· Post office</li> <li>· Senior center</li> <li>· Emergency shelter</li> </ul>	<ul style="list-style-type: none"> <li>· Clothing store or department store selling clothes</li> <li>· Hardware store</li> </ul>	<ul style="list-style-type: none"> <li>· Bank (with teller hours)</li> <li>· Hair care</li> <li>· Laundry, dry cleaner</li> <li>· Adult or senior care (licensed)</li> <li>· Childcare (licensed)</li> <li>· Social services center</li> </ul>

## RECOMMENDATIONS

- In conversations with existing (or potential) residents or building occupants or users and using other assessment tools like the Enterprise Opportunity Report (Opportunity360), identify the most needed services and community resources in your area.
- Make the pedestrian experience safe and comfortable. Consider using some of the following techniques to make pedestrian paths more enjoyable and accessible: tactile curb warning ramps, additional pedestrian-scale lighting, clearly marked crosswalks, corner bulb outs, sidewalk benches, street trees/plantings, and pedestrian crossing signals.
- City, municipal, and county governments (e.g., local planning department, health department) can serve as valuable resources to better understand community amenities.

## RESOURCES

- State of Place. “State of Place quantifies why people are drawn to live, work, and play in places - based on 290+ urban, street-level amenities.” [www.stateofplace.co/](http://www.stateofplace.co/)
- Walkscore. [www.walkscore.com/](http://www.walkscore.com/)
- Google Maps offers a function to demonstrate walk distance. On Google Maps, go to “Directions” and select “Walk Directions” to obtain this information. [www.google.com/maps](http://www.google.com/maps)
- Safe Routes to School National Partnership. This network of more than 300 nonprofit organizations, government agencies, schools, and professionals works to advance the Safe Routes to School (SRTS) movement in the United States. SRTS can provide a variety of important benefits to children and their communities, including increasing physical activity, reducing traffic congestion, improving air quality, and enhancing neighborhood safety. [www.saferoutespartnership.org/home](http://www.saferoutespartnership.org/home)
- Resilient City Urban Design Principles. A resilient post-carbon community, which reorients city life to the pedestrian scale (a 500-mile radius), must focus its efforts on creating several local destinations, which attract a critical mass of users and activities. [www.resilientcity.org/index.cfm?id=11928](http://www.resilientcity.org/index.cfm?id=11928)
- The National Association of Area Agencies of Aging (n4a). This resource can be used to find aging-in-place service providers in your area. [www.n4a.org/](http://www.n4a.org/)
- U.S. Department of Health and Human Services, U.S. Administration on Aging, Eldercare Locator. This resource can be used to find home- and community-based service providers in your area. [eldercare.acl.gov/Public/Index.aspx](http://eldercare.acl.gov/Public/Index.aspx)
- Consider using a technology like TransitScreen in your building’s common space(s) to provide real-time transportation information to building residents and staff. [transitscreen.com](http://transitscreen.com)
- University of Washington, College of Built Environments, Department of Architecture. Professor Anne Vernez-Moudon’s papers on walkability. [arch.be.uw.edu/people/anne-vernez-moudon/](http://arch.be.uw.edu/people/anne-vernez-moudon/)

## 2.6

### **BASELINE FOR NEW CONSTRUCTION RURAL/TRIBAL/SMALL TOWN PRESERVATION OF AND ACCESS TO OPEN SPACE FOR RURAL/TRIBAL/ SMALL TOWN**

#### **RATIONALE**

Open space is more than just a land asset for development; it is an amenity that attracts and welcomes the broader community. Access to safe open space and other natural resources improves quality of life, enhances opportunities for physical activity and social interaction/connection, and provides the opportunity to better understand the natural ecosystem and regional identity.

#### **REQUIREMENTS**

##### ***Option 1***

Locate the project within a 0.25 mile walk distance of dedicated, public open space that is a minimum of 0.75 acres and is open and accessible to all building users. A minimum of 80% of the public open space must be non-paved.

OR

##### ***Option 2***

Set aside a minimum of 10% (minimum of 0.25 acre) of the total project acreage as permanent open space that is open and accessible to all building users. A minimum of 80% of the open space must be non-paved.

Notes (for all options):

- When calculating open space, be sure to deduct buildings, private outdoor areas, streets/roadways and vehicle parking from your total site area.
- Green roofs can be used in open space calculations if the roof area is accessible to all residents.
- Land that is set aside for future development cannot be included as open space in these calculations.

---

## RECOMMENDATIONS

- To determine if your project qualifies as Rural/Tribal/Small Town, reference the definitions in the Appendix J.
- Be sure to consider security and maintenance of all open spaces included on-site.
- Design building massings to enhance nearby parks, plazas, and open spaces.
- Open spaces should be safe and designed to promote active use by residents. Features such as active bike and walking trails/paths, lighting, seating options, native plantings and recreation facilities make open spaces a community amenity.
- Open spaces should complement the cultural preferences of the local population and accommodate people of all ages.

## RESOURCES

- U.S. Environmental Protection Agency, Smart Growth and Open Space Conservation. [www.epa.gov/smartgrowth/openspace.htm](http://www.epa.gov/smartgrowth/openspace.htm)
- The Trust for Public Land. Creates parks and protects land for people, ensuring healthy, livable communities for generations to come. [www.tpl.org/](http://www.tpl.org/)
- The Trust for Public Land, ParkScore Index. A rating system developed to measure how well U.S. cities are creating parks. [www.tpl.org/parkscore](http://www.tpl.org/parkscore)



## 2.7

### OPTIONAL 6 POINTS MAXIMUM

## PRESERVATION OF AND ACCESS TO OPEN SPACE

### RATIONALE

See Rationale for Criterion 2.6.

### REQUIREMENTS

#### Option 1

Locate the project within a 0.25-mile walk distance of dedicated, accessible public open space that is a minimum of 0.75 acres. A minimum of 80% of the public open space must be non-paved. *[4 points]*

OR

#### Option 2

Set aside a percentage of the total project acreage as permanent open space that is open and accessible to all project users. A minimum of 80% of the open space must be non-paved.

PERCENTAGE OF OPEN SPACE SET ASIDE	NUMBER OF OPTIONAL POINTS
25%	2 points
35%	4 points
45% + submitted written statement of preservation/conservation policy for set-aside land (for 15 years)	6 points

Notes (for all options):

- When calculating open space, be sure to deduct buildings, private outdoor areas, streets/roadways, and vehicle parking from your total site area.
- Green roofs can be used in open space calculations if the roof area is accessible to all residents.
- Land that is set aside for future development cannot be included as open space in these calculations.

### RECOMMENDATIONS

See Recommendations for Criterion 2.6.

### RESOURCES

See Resources for Criterion 2.6.

## 2.8

### OPTIONAL 2 OR 3 POINTS

## ACCESS TO TRANSIT

### RATIONALE

Projects located near transit reduce a resident's or project user's need to own or rely upon a car, thereby eliminating or lowering the costs of auto ownership. Transit use and biking reduces consumption of fossil fuel and related emissions of air pollutants and carbon dioxide. In addition, locating near high-frequency transit typically allows project users or residents to access major employment centers, and can provide opportunities for increased physical activity through active transportation, improving health. Bicycle facilities can significantly increase the area served by public transit, as distances too long to walk are often easily accessible by bicycle.

### REQUIREMENTS

#### ***Fixed Route Services***

Provide a schedule specifying fixed stop(s) relating to points being requested and a Google map using walking directions to show location of proposed property and location to one or more bus stops within .50 (1/2) mile. If using latitude and longitude because an address is not available, the starting point should be located on the entrance driveway within the property's boundary to the nearest bus stop.

#### ***Fixed Route Service***

Fixed route bus service available within .5 (1/2) mile walking distance of the property in which the bus stops at least twenty (20) times per weekday. *[3 points]*

Fixed route bus service available withing .5 (1/2 mile) walking distance of the property in which the bus stops at least ten (10) times per weekday. *[2 points]*

#### ***Dial-a-Ride Services***

Provide the name of the transit provider and documentation of regularly scheduled hours and days of operation. Transit must be available to the general public.

#### ***Dial-A-Ride Communities without Fixed Route Service***

Rides are scheduled for pick up at your door or by the curb from their residence to a location of choice. *[2 points]*

---

## RECOMMENDATIONS

Work with your local transit provider to identify nearby transit stops and to plan for provision of transit service to your new development.

Many cities and counties provide bicycle trail and route maps for free download on their websites.

## RESOURCES

- Google Maps offers a function to demonstrate walk distances and to identify bicycle trail and route maps. On Google Maps, go to “Get Directions” and select “Walking” or “Bicycling,” as applicable, to obtain this information. [www.google.com/maps](http://www.google.com/maps)
- Consider using a technology like TransitScreen in your building’s common space(s) to provide real-time transportation information to building residents and staff. [transitscreen.com/](http://transitscreen.com/)
- Victoria Transportation Policy Institute. This independent research organization provides consulting and publicly available research about solutions to emerging transportation issues, such as transportation demand management. [www.vtppi.org](http://www.vtppi.org)
- National Center for Mobility Management, Profiles of Innovative Rural Vanpool Programs. This resource describes several exceptional vanpool programs around the country.
- The City of Oakland California, Engineering and Construction—Bikeway Types. This resource is helpful to better understand the differences between Class I, Class II and Class IV bike lanes. [www2.oaklandnet.com/government/o/PWA/o/EC/s/BicycleandPedestrianProgram/OAK024595](http://www2.oaklandnet.com/government/o/PWA/o/EC/s/BicycleandPedestrianProgram/OAK024595)
- National Association of City Transportation Officials, Bike Lanes. [nacto.org/cities-for-cycling/design-guide/bike-lanes/](http://nacto.org/cities-for-cycling/design-guide/bike-lanes/)

## 2.9

### OPTIONAL 2-8 POINTS

# IMPROVING CONNECTIVITY TO THE COMMUNITY

## RATIONALE

Connections to adjacent development and public, open spaces promote recreational walking, biking, and alternative means of commuting as well as other healthy lifestyle choices. Safe and accessible connections to amenities and open space can reduce isolation and increase equity by making it easier for residents to access community amenities, including transit. Research shows that low-income communities and communities of color often do not have access to these benefits, and this has led to lower levels of physical activity and high rates of chronic diseases, as well as limited access to quality jobs. Increasing access to safe, complete sidewalks, bike paths, open spaces and community amenities is a step toward reducing inequities created by our built environment.

## REQUIREMENTS

Improve access to community amenities through at least one of the measures below. To earn optional points under this criterion, projects achieve at least 2 points.

### *Incentivize Biking Mobility*

- Provide outdoor bicycle racks that are accessible for visitors and residents. [1 point]
- Provide secure, lockable, sheltered, and accessible bicycle storage. Provide at least one bicycle parking space for every residential unit and for every 2,000 square feet of gross floor area for commercial projects. Post signage directing to bicycle parking areas and programs. [2 points]
- Provide bicycles and equipment (e.g., helmets, locks, tire pumps, maintenance equipment) for resident/tenant use. [4 points]
- Promote use of, and access to, one or more bicycle-share/micro-mobility (scooter) programs within 0.25-mile of the building. Bicycles and scooters need to be accessible to occupants at all hours. Maps to the nearest bike station and scooter docking facility should be posted in a visible location within a common area in the building and included in the Occupant Manual (Criterion 8.3). [2 points]
- Provide residents and building occupants with discounted bicycle-share/micro-mobility (scooter) memberships for a period of at least 12 months. [2 points]
- Provide project users with free bicycle-share memberships for a period of at least 12 months. [4 points]

### ***Improving Access***

- Provide project users with discounted transportation passes for a period of at least 12 months. [2 points]
- Provide residents/project users with free transportation passes for a period of at least 12 months. [4 points]
- Include car-share services (parking) on property. [1 point]
- Provide all eligible residents/project users with discounted car-share memberships for a period of at least 12 months. [2 points]
- Provide a minimum of 50% of eligible residents/project users with free car-share memberships for a period of at least 12 months. [4 points]

### **RECOMMENDATIONS**

- When considering enhancing access to alternative modes of transportation, gather community input to learn what they would see as benefiting their community.
- Safety should be encouraged when considering opportunities for biking, walking, driving, and parking. Consider promoting designs that encourage slow-speed, low-volume roadways, thereby enhancing pedestrians' and bikers' safety.
- Provide orientation materials and maps to the nearest bus, transit stations, and car-share or bike-share facilities (general orientation materials are acceptable for floating car- or bike-share services). Information about these amenities should be posted in a visible location in a common area in the building and included in the Occupant Manual (Criteria 8.3).
- Consider offering a credit for residents/project users to try their local car-share or bike-share service (if available). Contact the provider of these services to see if they would like to offer a discount or credit to encourage use.
- Incorporate street trees and furniture such as benches, trash receptacles, and bicycle racks to create an active streetscape.
- For ease of use, bicycle storage is ideally incorporated on the ground floor with direct roll-in access that is separate and distinct from automobile access. Push-button doors make roll-in access even more convenient for riders, especially during inclement conditions.
- Provide bicycle storage for staff as well as residents.
- Make bicycle and pedestrian routes to parks and public spaces safe and visible.
- Provide shade for bicycle and pedestrian routes to protect residents from heat island effect and extend usage hours.
- Conduct an assessment to determine most likely routes of pedestrian and bicycle use when laying out paved pathways/sidewalks from the project to the surrounding neighborhood. Build the pathways/sidewalks where there is visible evidence of pedestrian and bicycle use.
- To encourage pedestrian activity, minimize vehicular curb cuts on streets with heavy foot traffic; construct curb extensions along sections of the sidewalk that tend to attract greater pedestrian congestion and that are close to pedestrian crossings.
- Dedicated pedestrian and bicycle paths are important even on dead-end streets.
- Install street features that have been shown to effectively calm traffic, including curb extensions, medians, roundabouts, and raised speed-reducers.

---

## RESOURCES

- NYC Departments of City Planning, Health and Mental Hygiene, and Design and Construction. Active Design Supplement: Shaping the Sidewalk Experience (2013). [www1.nyc.gov/assets/planning/download/pdf/plans-studies/active-design-sidewalk/active\\_design.pdf](http://www1.nyc.gov/assets/planning/download/pdf/plans-studies/active-design-sidewalk/active_design.pdf)
- Robert Wood Johnson Foundation, Active Living Research. [activelivingresearch.org/](http://activelivingresearch.org/)
- Transportation for America, The Scenic Route: A primer on creative placemaking in transportation. [www.americansforthearts.org/sites/default/files/Creative-Placemaking-Web.pdf](http://www.americansforthearts.org/sites/default/files/Creative-Placemaking-Web.pdf)
- Task Force on Community Preventive Services, The Community Guide: What Works to Promote Health. [www.thecommunityguide.org/resources](http://www.thecommunityguide.org/resources)
- Task Force on Community Preventive Services, The Community Guide: Street-Scale Urban Design Land Use Policies. [www.thecommunityguide.org/sites/default/files/PA-Street-Scale-Archive.pdf](http://www.thecommunityguide.org/sites/default/files/PA-Street-Scale-Archive.pdf)
- PolicyLink report on research and recommendations for Healthy Equitable Transportation Policy. [www.policylink.org/sites/default/files/HEALTHTRANS\\_FULLBOOK\\_FINAL.PDF](http://www.policylink.org/sites/default/files/HEALTHTRANS_FULLBOOK_FINAL.PDF)

## 2.10

### OPTIONAL 5 POINTS MAXIMUM

## PASSIVE SOLAR HEATING/COOLING

### RATIONALE

The use of passive solar design minimizes need for mechanical heating, lowers cooling loads, and increases access to natural daylight. Passive solar heating, cooling-load avoidance strategies and a knowledge of prevailing winds are valuable in protecting the well-being of building occupants during extended power outages or interruptions in heating fuel.

### REQUIREMENTS

Design and build project with passive solar design, orientation, and shading that meets the following guidelines.

PROJECT TYPE	POTENTIAL POINTS	REQUIREMENTS
New Construction Stand-alone building	5	Meet all guidelines
New Construction Projects with multiple buildings	2	25% of the buildings meet all guidelines
	3	50% of the buildings meet all guidelines
	4	75% of the buildings meet all guidelines
	5	90% of the homes meet all guidelines
Rehabs Moderate or Substantial	3	All new windows must comply with the glazing type guidelines, by Climate Zone (Guideline 1)
	2	All south-facing elevations must comply with shading guidelines, by Climate Zone (Guideline 4)

## GUIDELINES

### *Glazing Types*

At a minimum, provide windows that are ENERGY STAR Certified, meet the requirements of Section 5.1 and are appropriate to the climate zone per IEDA's Window and Exterior Door Selection Guide, [iowaeda.com/userdocs/programs/cdbg-hsg-window-exterior-door.pdf](http://iowaeda.com/userdocs/programs/cdbg-hsg-window-exterior-door.pdf).

### *Orientation, Glazing Placement and Shading*

1. Building orientation. Orient the building so that the longer side faces within 15 degrees of north–south.
2. Glazing. Climate Zones 1–3: The glazing area on the north- and south-facing façades should be 50% greater than the sum of the glazing areas on the east- and west-facing walls; Climate Zones 4–7: The glazing area on the south-facing façade should be 30% greater than the sum of the glazing areas on the east-, west- and north-facing façades.
3. Shading. For south-facing windows, follow the shading requirements in the following table and the map in the Appendix G.

### *Requirements for Shading*

To find your Climate Zone, see IECC Climate Zone Map in the Appendix G. As of August 2019, those requirements are as listed:

CLIMATE ZONE (IECC CLIMATE MAP)	PERCENTAGE OF WINDOW THAT NEEDS TO BE SHADED BY JUNE 21
1, 2	95%
3	75%
4 except Marine	75%
4 Marine, 5, 6, 7, 8	50%

## RECOMMENDATIONS

- Interior spaces requiring the most lighting and heating should be along the south face of the building.
- Include a narrow floor plate (less than 40 feet), single-loaded corridors and an open floor plan to optimize daylight and natural ventilation by accommodating the natural ventilation of prevailing winds.
- Thermal Massing, Climate Zones 2–7:
  - Locate a material with high thermal mass on the southern portion of the house where sunlight hits during the heating season.
  - Materials with thermal mass include brick, concrete, stone, water and any other high-density material.
- Passive cooling strategies:
  - Plant deciduous shade trees at the south façades.
  - Maximize cross ventilation by installing operable windows at the leeward and windward sides of the building.
  - Install light-colored roofing or coat existing roofs with light-colored elastomeric coatings.



---

## RESOURCES

- U.S. Department of Energy, Building Technologies Office, Passive Solar Heating and Cooling. [energy.gov/energysaver/articles/tips-passive-solar-heating-and-cooling](https://www.energy.gov/energysaver/articles/tips-passive-solar-heating-and-cooling)
- 2018 IECC Climate Zones Map. A detailed map that shows Climate Zones zoomed into each state and county as well as the basic 2018 IECC Building Code requirements for each Climate Zone (see the Appendix G).
- U.S. Department of Energy, National Renewable Energy Laboratory, “Passive Solar Design for the Home,” Report #DOE/GO-102001-1105, February 2001. [www.nrel.gov/docs/fy01osti/27954.pdf](http://www.nrel.gov/docs/fy01osti/27954.pdf)
- U.S. Department of Energy, Passive Solar Design. [www.energy.gov/energysaver/energy-efficient-home-design/passive-solar-home-design](https://www.energy.gov/energysaver/energy-efficient-home-design/passive-solar-home-design)
- Passive Solar Architecture, by David Bainbridge and Ken Haggard, Chelsea Green Publishing, 2011.

## 2.11

### OPTIONAL 10 POINTS

## ADAPTIVE REUSE OF BUILDINGS

### RATIONALE

The reuse of existing structures reduces landfill waste, reduces the need for new materials, and reduces pressure to develop undeveloped land. Adaptive reuse techniques extend the useful life of existing structures. Preserving and adapting existing buildings can help reinforce the unique sense of history of your community by retaining known built forms.

### REQUIREMENTS

Rehabilitate and adapt an existing structure. Design the project to adapt, renovate, or reuse at least 50% of the existing structure and envelope (includes exterior skin and framing and excludes window assemblies and non-structural roofing).

Projects with multiple buildings are eligible for optional points in this criterion so long as one of the buildings is being renovated and adaptively reused.

### RESOURCES

- Iowa Brownfield/Grayfield Tax Credit Program promotes the economic health of communities by reducing environmental potential hazards, cleaning up eyesores, creating new jobs and boosting tax revenue. [iowaeda.com/Regulatory/brownfield](http://iowaeda.com/Regulatory/brownfield)
- Iowa Brownfield Redevelopment Program provides technical assistance and potentially financial assistance for select projects. [www.iowadnr.gov/Environmental-Protection/Land-Quality/Contaminated-Sites/Brownfields](http://www.iowadnr.gov/Environmental-Protection/Land-Quality/Contaminated-Sites/Brownfields)
- U.S. Environmental Protection Agency, Brownfields Cleanup and Redevelopment Program provides grants and technical assistance to communities, states, tribes and others to assess, safely clean up and sustainably reuse contaminated properties. [www.epa.gov/brownfields](http://www.epa.gov/brownfields)
- Center for Community Progress provides assistance to communities to help turn vacant spaces into vibrant places. [www.communityprogress.net](http://www.communityprogress.net)
- State of Place's predictive software can assist communities in making wise investments to create walkable, livable and smarter places. [www.stateofplace.co](http://www.stateofplace.co)
- National Trust for Historic Preservation, Preservation Leadership Forum. Untapped Potential: Strategies for Revitalization and Reuse. [forum.savingplaces.org/viewdocument/untapped-potential-strategies-for](http://forum.savingplaces.org/viewdocument/untapped-potential-strategies-for)
- Municipal Research and Services Center of Washington, Infill Development Strategies for Shaping Livable Neighborhoods. This site contains an overview of strategies for encouraging and implementing infill development patterns. <http://mrsc.org/Home/Explore-Topics/Planning/Development-Types-and-Land-Uses/Infill-Development-Completing-the-Community-Fabric.aspx>



- 
- Center for Community Progress. This website provides information, resources, tools and assistance to support vacant property revitalization efforts. [www.communityprogress.net](http://www.communityprogress.net)
  - Eight Strategies for Cities Trying to Promote Adaptive Reuse of Buildings (June 2018). [brownfieldlistings.com/blog/post/eight-strategies-for-cities-trying-to-promote-adaptive-reuse-of-buildings](http://brownfieldlistings.com/blog/post/eight-strategies-for-cities-trying-to-promote-adaptive-reuse-of-buildings)
  - 10 Principles for ReUrbanism: Reuse and Reinvestment in the 21st Century. [forum.savingplaces.org/blogs/forum-online/2016/09/07/ten-principles-for-reurbanism-reuse-and-reinvestment-in-the-21st-century](http://forum.savingplaces.org/blogs/forum-online/2016/09/07/ten-principles-for-reurbanism-reuse-and-reinvestment-in-the-21st-century)

## 2.12

### OPTIONAL 6 POINTS

## ACCESS TO FRESH, LOCAL FOODS

### RATIONALE

Access to fresh produce offers healthy food options for residents, and purchase of fresh produce directly from farmers demystifies the cycle of food production. This measure also supports local economic development that increases the economic value and production of farmlands and community gardens. An ability to obtain local food offers important resilience benefits should major U.S. agricultural areas in the Midwest and California be threatened, for instance.

### REQUIREMENTS

#### *Option 1: Neighborhood Farms and Gardens*

Provide permanent space for food growing within the project site that is equal or greater in size to 10 square feet per dwelling unit for 50% of the dwelling units. Provide watering systems, secure storage space for tools, and safe access for residents to the gardening spaces. Ensure that the gardens are built and maintained in a manner to minimize pests through nontoxic methods such as Integrated Pest Management practices. Ensure that the food-growing space is managed by an entity that includes residents in its decision-making, such as a resident council/committee or homeowners' association.

OR

#### *Option 2: Community-Supported Agriculture*

Offer a specified location within the project boundaries for delivery of community-supported agriculture (CSA) or fresh food share program shares for residents, project staff, and surrounding community members, as appropriate. Shares must be delivered to the specified delivery point on a regular schedule at least twice a month for at least four months of the year.

OR

#### *Option 3: Proximity to Farmers Market*

Locate the project's geographic center within a 0.5-mile walk distance of an existing or planned farmers market that will operate at least once a week for at least five months of the year, or for a length of time proportional to the growing season for the project's vicinity. A planned farmers market must have firm commitments from vendors that the market will meet all of the above requirements and be in full operation by the time there is 50% occupancy of the project's dwelling units.

## RECOMMENDATIONS

- For projects pursuing Option 1, consider bringing in an individual or a group (e.g., a master gardener or a garden club) to work with the residents to establish the garden and maintain productivity.
- For projects pursuing Option 1, consider allocating additional square footage for support areas for community gardening (i.e., pathways, sheds, storage areas).
- Grow and/or plant foods that have cultural connection for residents—either familiar or traditional foods—and/or allow residents to decide what to grow. Plantings may also include food-bearing shade trees and ornamental shrubs.
- Encourage fresh food providers, including those who organize farmers markets and run food cooperatives (co-ops), to accept Electronic Benefit Transfer (EBT) and Supplemental Nutrition Assistance Program (SNAP).
- Incorporating cooking classes for residents into your resident engagement program (see Category 8: Operations, Maintenance + Occupant Engagement) is an excellent way to incentivize residents to eat healthy and prepare meals with fresh foods. Cooking classes are a fun and creative way to raise awareness and understanding of cultural diversity in a place, as well as a way to build community/ social cohesion within a development.

## RESOURCES

- Iowa Department of Agriculture and Land Stewardship Farmers Market Directory. [iowaagriculture.gov/agricultural-diversification-market-development-bureau/horticulture-and-farmers-markets](http://iowaagriculture.gov/agricultural-diversification-market-development-bureau/horticulture-and-farmers-markets)
- Iowa Community Supported Agriculture (CSA) Directory [www.extension.iastate.edu/ffed/iowa-csa-directory](http://www.extension.iastate.edu/ffed/iowa-csa-directory)
- Local Harvest. This website offers a search function to find farmers markets, family farms and other sources of local, sustainably grown food in a given area. [www.localharvest.org](http://www.localharvest.org)
- U.S. Department of Agriculture, National Agricultural Library, Food and Nutrition Information Center, Community Food Systems. This website links to dozens of publications, programs and other sites. [fnic.nal.usda.gov/](http://fnic.nal.usda.gov/)
- U.S. Department of Agriculture, Economic Research Service. The USDA, Treasury Department and HHS have defined a “food desert” as a census tract with a substantial share of residents who live in low-income areas that have low levels of access to a grocery store or healthy, affordable food retail outlet. Use this resource to determine if your project is located in a food desert. [www.ers.usda.gov/data-products/food-access-research-atlas/go-to-the-atlas.aspx](http://www.ers.usda.gov/data-products/food-access-research-atlas/go-to-the-atlas.aspx)
- Centers for Disease Control and Prevention, Community Food Assessment. The purpose of a community food assessment (CFA) is to determine the locations and incidence of food deserts—that is, areas with limited access to healthy and fresh food—and inform decision-makers of those areas that need intervention. [www.cdc.gov/healthyplaces/healthtopics/healthyfood/community\\_assessment.htm](http://www.cdc.gov/healthyplaces/healthtopics/healthyfood/community_assessment.htm)
- The Grocery Gap, Who Has Access to Healthy Food and Why it Matters. The Food Trust and PolicyLink, 2016. [thefoodtrust.org/uploads/media\\_items/grocerygap.original.pdf](http://thefoodtrust.org/uploads/media_items/grocerygap.original.pdf)
- Enterprise Community Partners, Fresh, Local Food Access Toolkit. This toolkit, which is designed to provide step-by-step instructions and resources to implement a fresh food access model that meets the Enterprise Green Communities Access to Fresh, Local Food Criteria, best addresses the needs of your development, and leverages the assets of your organization and neighborhood. [www.enterprisecommunity.org/resources/fresh-local-food-access-toolkit-new-york-14222](http://www.enterprisecommunity.org/resources/fresh-local-food-access-toolkit-new-york-14222)

## 2.13

### OPTIONAL 8 POINTS

# ADVANCED CERTIFICATION: SITE PLANNING, DESIGN AND MANAGEMENT

### RATIONALE

Project teams that have certified projects to these advanced site standards have taken steps to minimize the environmental impact of land development practices and emphasize themes of responsible land use, smart growth, urbanism and green building.

### REQUIREMENTS

Locate building(s) within a community that is certified in one the following programs:

- LEED for Neighborhood Development
- LEED for Cities and Communities
- Living Community Challenge
- SITES

### RESOURCES

- U.S. Green Building Council, LEED for Neighborhood Development. This page has links to the LEED-ND rating system, a project checklist, and information on certification.  
[www.usgbc.org/leed#rating](http://www.usgbc.org/leed#rating)
- LEED for Cities and Communities. This page has a good breakdown of how the program works and how to certify, and a list of cities already registered to become a LEED City or Community.  
[new.usgbc.org/leed-for-cities](http://new.usgbc.org/leed-for-cities)
- Living Community Challenge. This page brings you to key resources of the program.  
[living-future.org/lcc/resources/#key-resources](http://living-future.org/lcc/resources/#key-resources)
- SITES. This page provides SITES certification overview and links to resources.  
[www.sustainablesites.org/certification-guide](http://www.sustainablesites.org/certification-guide)

## 2.14

### OPTIONAL 6 POINTS MAXIMUM

# LOCAL ECONOMIC DEVELOPMENT AND COMMUNITY WEALTH CREATION

### RATIONALE

Building projects can offer opportunities to directly enhance lives and quality of life in a community when they include physical space to accommodate various programs for learning, job skill development, and other social interactions. Numerous studies have documented the ways in which affordable housing projects have positive economic impacts on their surrounding neighborhoods. In some cases, small business focused economic development can help mitigate displacement of local-owned businesses, retaining employment opportunities.

### REQUIREMENTS

#### ***Option 1: Local Hiring Preference [2 points]***

Demonstrate that a local preference for construction employment and subcontractor hiring was part of your bidding process.

Notes:

- “Local preference” is defined as preference for any individual who resides within 25 miles of the project site.
- Indian Preference can be solely that, without a miles-to-project requirement.

AND/OR

#### ***Option 2: Local Employment [3 points]***

Demonstrate that you achieved at least 20% local employment.

To determine the percentage of local employment, calculate:

$(\text{Total \# of hours worked by local individuals} / \text{Total \# of hours on the project}) \times 100 = \% \text{ of local employment}$

Notes:

- If sweat equity hours were used to complete some of the labor for the project, those hours are eligible and should be included in the above calculation.
- “Local employment” is defined as any individual who resides within 25 miles of the project site.
- Indian Preference can be solely that, without a miles-to-project requirement.

AND/OR

***Option 3: Physical Space for Business, Nonprofits and/or Skill and Workforce Education [3 points]***

Provide physical space for business, nonprofits, and/or skills and workforce education. Points can be achieved by incorporating one of the strategies below:

- Providing space to conduct job skills training for building tenants and community. This training could focus on a variety of topics, including but not limited to, computer training, resume building, financial skills training, or other similar jobs skills training. If training is to be completed with internal staff, provide a 12-month training curriculum and outreach plan. If training is to be completed by a third-party provider, provide evidence of at least a two-year contract for these services.

OR

- Providing reduced-cost space for educational institutions and/or public education, demonstrated through signed leases.

OR

- Providing mixed-use space specifically to local/small businesses or nonprofits to accommodate economic development, demonstrated through signed leases. Local and small business must meet prevailing national definitions (i.e., no national chains, even if they are locally owned franchises or registered B Corporations).

OR

- Asset Development: Providing on-site financial services and asset development to tenants and community. This could be through annual tax assistance (e.g., EITC, free tax filing), savings programs (IDAs, financial literacy), or affordable lending (payday loan alternatives). A Community Development Financial Institution (CDFI) office or satellite in the facility would qualify for these points.

## **RECOMMENDATIONS**

If providing physical space for business, nonprofits, and/or skill and workforce education, prioritize leasing to tenants that would bolster the building and become neighborhood assets.

For instance, if your project has access to bike routes or trails, leasing space to a bicycle workshop or cooperative (co-op) would be one way to promote bicycle use and provide a valuable amenity to tenants and the community at large. Innovative bike programming may teach people how to ride bicycles, mentor people through using bicycles safely for everyday needs (e.g., winter biking), let people check out bicycles, teach bicycle maintenance, and more.

Commercial and/or educational spaces should have doors or direct access to the street at grade. At a minimum, commercial/educational space should have visual connections to the outdoors.



---

## RESOURCES

- Section 3 of the Housing and Urban Development Act of 1968, Overview. [iowaeda.com/cdbg/management-guide](http://iowaeda.com/cdbg/management-guide)
- Enterprise Community Partners, New Market Tax Credit (NMTC). NMTC applications factor in number of jobs created and living-wage jobs during and after construction and can serve as a valuable resource for understanding the impacts of local hiring. [www.enterprisecommunity.org/financing-and-development/new-markets-tax-credits](http://www.enterprisecommunity.org/financing-and-development/new-markets-tax-credits)
- National Cooperative Highway Research Program. More information on local (city, county) hiring preferences. [onlinepubs.trb.org/onlinepubs/nchrp/nchrp\\_LRD\\_59.pdf](http://onlinepubs.trb.org/onlinepubs/nchrp/nchrp_LRD_59.pdf)
- Slow Money, Principles for local investment. <https://slowmoney.org/principles>
- 1% for the Planet. Connects businesses, consumers, and nonprofits, empowering all of us to drive big, positive change. [www.onepercentfortheplanet.org/](http://www.onepercentfortheplanet.org/)

## 2.15a

### **BASELINE FOR NEW CONSTRUCTION AND SUBSTANTIAL REHABILITATION PROJECTS IN RURAL/TRIBAL/SMALL TOWN LOCATIONS**

## **ACCESS TO BROADBAND: BROADBAND READY**

### **RATIONALE**

Building owners have the opportunity to build pathways for future installation of broadband, significantly reducing barriers to connectivity for building users. Improving internet connectivity in rural locations is critical to ensuring that residents have access to opportunities such as access to programs, telemedicine, and job opportunities, and helps to narrow the digital divide between urban and rural communities.

### **REQUIREMENTS**

Design and build or retrofit the property to incorporate broadband infrastructure so that when broadband service comes to a community, the property can be easily connected. Include a network of mini-ducts or conduits throughout the building, extending from the expected communications access point to each network termination point in the building. Internet service (and its ongoing service fee) is not required.

Include:

- Conduit from the property line (expected broadband access point) to the utility room
- Conduit from the utility room through risers and/or other infrastructure and leads to the expected network termination points in each dwelling unit and common space

### **RECOMMENDATIONS**

- Broadband conduit would follow the same path as telephone and cable TV conduit.
- If broadband is provided elsewhere in your community, consult with local service providers to determine more precise specifications for the type of cable preferred, to more specifically ensure that your property is able to connect in future.
- Fiber connections and equipment are typically located in a dedicated electrical or telecom closet, often on a low floor in the building with access to riser spaces.
- Power and HVAC services will be helpful if the service provider plans to install active electronics in the closet.
- In occupied buildings undergoing a rehabilitation, conduit placement can be challenging. However, there are many alternative ways of making pathways for broadband infrastructure, including placing cables above drop ceilings or moldings, mounting small cables on wall surfaces, or running cables up the outsides of buildings into individual units. Fiber optic cables can be very small, and in many cases, the visual impact can be small.

## RESOURCES

- Connected Nation Iowa. <https://connectednation.org/iowa/>
- Federal Register, Narrowing the Digital Divide Through Installation of Broadband Infrastructure in HUD-funded New Construction and Substantial Rehabilitation of Multifamily Rental Housing. [www.federalregister.gov/d/2016-30708](http://www.federalregister.gov/d/2016-30708)
- Become Broadband Ready. A toolkit of practices and a first-stop resource for any community seeking strategies and solutions to connect its residents. [nextcenturycities.org/becoming-broadband-ready/](http://nextcenturycities.org/becoming-broadband-ready/)
- Broadband Communities. Guidelines to help building owners provide spaces, pathways and cables that service providers can use to deliver fiber optic services. [www.bbcmag.com/multifamily-broadband/making-a-building-fiber-ready](http://www.bbcmag.com/multifamily-broadband/making-a-building-fiber-ready)
- Next Century Cities, Webinar: Connecting Residents in Low-Income Housing. [www.youtube.com/watch?v=r3CZBIFHszU](http://www.youtube.com/watch?v=r3CZBIFHszU)
- City of Austin, Texas, Telecommunications and Regulatory Affairs, Digital Inclusion Strategy. [www.austintexas.gov/digitalinclusion](http://www.austintexas.gov/digitalinclusion)
- City of Kansas City, Missouri, Digital Equity Strategic Plan. [data.kcmo.org/api/file\\_data/7a21a1bd-39de-4e0f-a0d1-1cebed868033?filename=Digital%252520Equity%252520Strategic%252520Plan%252520DRAFT%2525203.0.pdf](http://data.kcmo.org/api/file_data/7a21a1bd-39de-4e0f-a0d1-1cebed868033?filename=Digital%252520Equity%252520Strategic%252520Plan%252520DRAFT%2525203.0.pdf)
- National Digital Inclusion Alliance, Digital Inclusion Resources. [www.digitalinclusion.org/resources/](http://www.digitalinclusion.org/resources/)
- National Digital Inclusion Alliance, The Digital Inclusion Coalition Guidebook. [www.coalitions.digitalinclusion.org/](http://www.coalitions.digitalinclusion.org/)
- United States Department of Commerce, National Telecommunications and Information Administration: Five Digital Inclusion Trends in the United States. [www.ntia.doc.gov/blog/2018/five-digital-inclusion-trends-united-states?utm\\_campaign=Newsletters&utm\\_source=sendgrid&utm\\_medium=email](http://www.ntia.doc.gov/blog/2018/five-digital-inclusion-trends-united-states?utm_campaign=Newsletters&utm_source=sendgrid&utm_medium=email)
- EveryoneOn, Low-Cost Internet Service & Affordable Devices. [www.everyoneon.org/lowcost-offers](http://www.everyoneon.org/lowcost-offers)
- Purdue University, Gauging Household Digital Readiness. [pcrd.purdue.edu/files/media/gauging-household-digital-readiness.pdf](http://pcrd.purdue.edu/files/media/gauging-household-digital-readiness.pdf)

## 2.15b

### OPTIONAL

*FOR RURAL/TRIBAL/SMALL TOWN | 6 POINTS*

## ACCESS TO BROADBAND: CONNECTIVITY

### RATIONALE

Improving internet connectivity in rural locations is critical to ensuring residents have access to opportunities such as access to programs, telemedicine, and job opportunities, and helps to narrow the digital divide between urban and rural communities.

### REQUIREMENTS

Ensure that all units and common amenity spaces in the property have broadband internet service provided at no cost to tenants with at least a speed of 25 megabits per second for downloading and 3 megabits per second for uploading (25/3).

“The community is really a ‘come together’ kind of community. People are about each other ...We care about how we live.”

Resident of Enterprise Green Communities property

### RECOMMENDATIONS

- Provide digital skills training for the property’s tenants, either directly or through partnerships with local anchor and/or civic institutions.
- Locate within 0.5 mile of schools and libraries, as these are often the first facilities in a community to receive broadband access through the E-Rate program mentioned below.

### RESOURCES

- Public Library Association, Digital Literacy. [www.ala.org/pla/initiatives/digitalliteracy](http://www.ala.org/pla/initiatives/digitalliteracy)
- E-Rate helps schools and libraries obtain affordable broadband. [www.fcc.gov/general/e-rate-schools-libraries-usf-program](http://www.fcc.gov/general/e-rate-schools-libraries-usf-program)

## SITE IMPROVEMENT

### INTRODUCTION CRITERIA CHECKLIST

- 1 INTEGRATIVE DESIGN
- 2 LOCATION +  
NEIGHBORHOOD FABRIC
- 3 SITE IMPROVEMENT
- 4 WATER
- 5 OPERATING ENERGY6  
MATERIALS
- 7 HEALTHY LIVING  
ENVIRONMENT
- 8 OPERATIONS,  
MAINTENANCE  
+ OCCUPANT  
ENGAGEMENT

### APPENDIX

LOW-IMPACT DEVELOPMENT PRINCIPLES MINIMIZE THE SITE'S ENVIRONMENTAL FOOTPRINT, PROTECT SENSITIVE ECOSYSTEMS, AND REDUCE INFRASTRUCTURE COSTS ASSOCIATED WITH STORMWATER MANAGEMENT.



# 3.1

## BASELINE ENVIRONMENTAL REMEDIATION

### RATIONALE

An environmental site assessment determines the potential environmental liabilities associated with property acquisition and ownership.

### REQUIREMENTS

Determine whether there are any hazardous materials present on-site by conducting either 1) a Phase I Environmental Site Assessment, 2) a Tier II Environmental Review Assessment per HUD funding requirements, 3) an environmental site assessment approved by HUD through the Part 50 or Part 58 process, or 4) an environmental assessment approved by USDA through the 1970 process, and any additional required assessments.

If an environmental site assessment reveals any hazardous materials, mitigate these contaminants before proceeding with development.

### RESOURCES

- U.S. Department of Housing and Urban Development, HUD Exchange Orientation to Environmental Reviews. This site hosts information about both Part 50 and Part 58 environmental review. [www.hudexchange.info/environmental-review/orientation-to-environmental-reviews/#overview](http://www.hudexchange.info/environmental-review/orientation-to-environmental-reviews/#overview)
- U.S. Department of Agriculture, Rural Development, Environmental Guidance. [www.rd.usda.gov/publications/environmental-studies/environmental-guidance](http://www.rd.usda.gov/publications/environmental-studies/environmental-guidance)



## 3.2

# BASELINE MINIMIZATION OF DISTURBANCE DURING STAGING AND CONSTRUCTION

### RATIONALE

Controlling erosion and sedimentation during site development keeps valuable topsoil on-site to reduce stormwater runoff and the sedimentation and pollution of local waterways that may be caused by construction debris. Protecting healthy soils during construction and remediating compaction minimizes the adverse effects of construction activities—compacted soils are less able to absorb water, resist plant root penetration, and lack the porosity needed for adequate aeration.

### REQUIREMENTS

For sites larger than one acre, implement U.S. Environmental Protection Agency (EPA)'s National Pollutant Discharge Elimination System (NPDES)'s Stormwater Discharges from Construction Activities guidance, or local requirements, whichever is more stringent.

For sites with an area equal to or less-than one acre, complete the following:

- Stockpile and protect high-quality topsoil from erosion, for reuse.
- Control the path and velocity of runoff with silt fencing or comparable measures.
- Protect ERPZs, on-site storm sewer inlets, watercourses and water bodies with straw bales, silt fencing, silt sacks, rock filters, or comparable measures.
- Provide swales to divert surface water from hillsides.
- Identify and protect significant, high value trees during construction (healthy tree with a diameter at breast height greater than 6"). Install tree protection fencing outside the critical root zone.
- If soil in a sloped area is disturbed during construction, use tiers, erosion blankets (geotextile mats), compost blankets, filter socks and berms, or some comparable approach, to keep soil stabilized.



## RECOMMENDATIONS

- Minimize mass site grading and keep grading footprint as small as possible; protect undisturbed soils from compaction during construction process.
- Create and implement an erosion, sedimentation, and pollutant control plan, commonly referred to as a stormwater pollution prevention plan (SWPPP) or erosion and sedimentation control plan (ESC) for all construction activities associated with the project. Plan should conform to the EPA's Construction General Permit or local erosion and sedimentation control standards and codes, whichever is more stringent. The plan should list the best management practices (BMPs) employed and describe how the BMPs accomplish the following objectives:
  - Prevent loss of soil during construction by stormwater runoff or wind erosion, including protecting topsoil by stockpiling or covering for reuse.
  - Prevent and reduce sediment discharges into storm conveyances, receiving waters, or other public infrastructure components or systems.
  - Prevent polluting the air with dust and particulate matter.
  - Prevent runoff and infiltration of other pollutants from construction sites (e.g., thermal pollution, concrete wash, fuels, solvents, hazardous chemical runoff, high or low pH discharges, pavement sealants) and ensure proper disposal of all construction related materials.
  - Protection of existing sounds (prevent compaction; implement mitigation/restoration)
  - Protection of existing trees
  - Protection of existing vegetation
- Critical root zone, or CRZ, is defined as the area of soil where roots required for future tree health and survival are located. This area can also be defined as a circle with a minimum radius of 1' for every 1" in trunk diameter at 4.5" above ground.
- High-quality topsoil is any topsoil that is suitable for planting. Consult a landscape architect, civil engineer, or your state university cooperative extension about the quality of soils on-site, before determining which soils are suitable for reuse on-site. In general, high-quality topsoils feature organic matter, appropriate pH levels, and nutrients.
- Support a net-zero waste site and minimize down-cycling of materials by diverting, reusing, or recycling construction and demolition materials to avoid disposal in landfills or combustion in incinerators.

## RESOURCES

- Iowa DNR Wastewater Permitting. [www.iowadnr.gov/Environmental-Protection/Water-Quality/NPDES-Wastewater-Permitting](http://www.iowadnr.gov/Environmental-Protection/Water-Quality/NPDES-Wastewater-Permitting)
- Iowa Stormwater Education Partnership stormwater pollution prevention plan information. [iowastormwater.org/regulations/swppps/](http://iowastormwater.org/regulations/swppps/)
- U.S. Environmental Protection Agency, Stormwater Discharge from Construction Activities. [www.epa.gov/npdes/stormwater-discharges-construction-activities](http://www.epa.gov/npdes/stormwater-discharges-construction-activities)
- U.S. Environmental Protection Agency, National Pollutant Discharge Elimination System. [www.epa.gov/npdes](http://www.epa.gov/npdes)
- Texas A&M Forest Service, Best Management Practices for Tree Protection. [isatexas.com/wp-content/uploads/2015/11/BMPs-Tree-Protection.pdf](http://isatexas.com/wp-content/uploads/2015/11/BMPs-Tree-Protection.pdf)
- EnviroCert International, Inc. Use the International Registry of Certified Professionals in Environmental Specialties to find erosion and sedimentation control professionals in your state. [envirocertintl.org/](http://envirocertintl.org/)





## 3.3

### **BASELINE** *IF PROVIDING LANDSCAPING* **ECOSYSTEM SERVICES/LANDSCAPE**

#### **RATIONALE**

Ecosystem services are the functions provided by the living landscape. Soil and vegetation absorb and purify stormwater to protect receiving water bodies. Trees create shade, protect from wind, and help to regulate the climate. Plants capture particulate matter and sequester carbon to help moderate climate and reduce air pollution. Native and adaptive plants are more resistant to naturally occurring disease, insects, drought, low levels of nutrients and major storm events, while reducing or eliminating the need for fertilizers, pesticides, herbicides, and irrigation. Research suggests that the incorporation of natural elements in the built environment can generate ecosystem services to protect and improve a community's quality of life and resiliency to climate change.

#### **REQUIREMENTS**

If providing plantings, all plantings (trees, shrubs, and groundcover, including grasses) should be native or climate-appropriate (adapted) to the region. All new plantings must be appropriate to the site's soil and microclimate. Do not introduce any invasive plant species. All disturbed areas should be planted, seeded or xeriscaped.

#### **RECOMMENDATIONS**

- Minimize mass site grading and keep grading footprint as small as possible; protect undisturbed soils from compaction during construction process.
- Consult a landscape architect or your local arborist during the integrative design process to identify appropriate areas for landscaping and shading.
- Consider developing a soils management plan to: identify, protect, and reuse high-quality site soils; to identify disturbed soils; and to outline a soil restoration process.
- Provide adequate horticultural soil volume for new tree plantings. Reference the ANSI A300 standards as managed by the Tree Care Industry Association for more details.
- When removing invasive species, be careful that your removal and transferring of invasive plant material limits site disruption and does not compact soil.
- Consider the proximity of plantings to your building, especially in areas prone to fires. Reducing or eliminating flammable material in a defined perimeter around your structure can be an effective mitigation technique in areas prone to wildfires.
- In areas where water shortages are common, consider xeriscaping, a landscaping strategy that uses drought-resistant plants to significantly reduce or eliminate the need for irrigation.
- Integrate the landscape plans with the stormwater management plan to provide drainage, maximize stormwater absorption, and direct water to plantings to reduce the need for irrigation.



- While turf may be appropriate for some landscaping, such as for play areas, it should be minimized wherever possible. Turf grass is resource intensive due to irrigation and mowing requirements. The cumulative effects of regular mowing contribute to air and noise pollution. Applications of chemical fertilizers, and herbicides contribute to pollution of waterways and can adversely affect native habitat.
- The project team should strive to use only organic and nontoxic fertilizers, pesticides, herbicides, fungicides, and pre-emergents.
- Where possible, create walking pathways and seating to encourage pedestrian activity. Establishing a tree canopy, especially along pathways and gathering areas like seating, is important to creating a welcoming, comfortable public space.
- If possible, existing invasives should also be mitigated/removed. Local cooperative extensions often maintain best practices for mitigation.
- Provide visually appealing environments along paths of travel with visually interesting landscaping (e.g., a variety of colors, textures, and flowering times).
- Ensure that the expected heights of plants adjacent to pedestrian walkways or seating areas are appropriate to maintain visibility into and out of the corridor in order to facilitate a safe and secure environment.
- If possible, limit turf or high-water-using species to 20% of the total landscape area, as suggested by the City of Santa Monica (Calif.) Landscape Standards.

## RESOURCES

- ReScape California. This California nonprofit educates about and advocates for a regenerative, whole systems approach to landscaping that works in harmony with the natural environment. Find ReScape qualified professionals, tools, and the ReScape Rating System for multifamily landscapes that have an irrigated area of 2,500 or more. [rescapeca.org/rated-landscapes/process/](https://rescapeca.org/rated-landscapes/process/)
- Native Plant Information Network. This site, maintained by the Lady Bird Johnson Wildflower Center, includes a database of native wildflowers, plants, and landscapes throughout North America. The website also includes a National Suppliers Directory. [www.wildflower.org/explore/](http://www.wildflower.org/explore/)
- Tree Care Industry Association, ANSI A300 Standards. [www.tcia.org/TCIA/Build\\_Your\\_Business/A300\\_Standards/A300\\_Standards.aspx?WebsiteKey=b9a41e1f-978d-4585-9172-c411c78c5c14](http://www.tcia.org/TCIA/Build_Your_Business/A300_Standards/A300_Standards.aspx?WebsiteKey=b9a41e1f-978d-4585-9172-c411c78c5c14)
- Northeast Organic Farming Association (NOFA) of Connecticut, NOFA Standards for Organic Land Care. These standards were developed to promote a sustainable ecological landscaping system that promotes and enhances biodiversity, biological cycles, and soil biological activity. [www.organiclandcare.net/sites/default/files/nofa\\_organic\\_land\\_care\\_standards\\_6thedition\\_2017\\_opt.pdf](http://www.organiclandcare.net/sites/default/files/nofa_organic_land_care_standards_6thedition_2017_opt.pdf)
- City of Seattle, Seattle Public Utilities. Seattle maintains many helpful resources concerning sustainable, natural care of plants and lawns, including information on planting selection, installation, and maintenance. [www.seattle.gov/utilities/businesses-and-key-accounts/landscapes/lawns-plants-and-trees](http://www.seattle.gov/utilities/businesses-and-key-accounts/landscapes/lawns-plants-and-trees)
- U.S. Department of Agriculture, National Invasive Species Information Center. As part of the USDA's National Agricultural Library, NISIC serves as a reference gateway to information, organizations, and services about invasive species. [www.invasivespeciesinfo.gov/plants/main.shtml](http://www.invasivespeciesinfo.gov/plants/main.shtml)
- U.S. Department of Agriculture, Agricultural Cooperative Extension System. Lists of local drought-tolerant plants may be available from local USDA Agricultural Cooperative Extension System offices, as well as through numerous online resources. [nifa.usda.gov/cooperative-extension-system](http://nifa.usda.gov/cooperative-extension-system)



- 
- U.S. Forest Service, “Celebrating Wildflowers.” This site has extensive information on native gardening, selecting appropriate native plants and invasive plant species, and has basic instructions for restoration and native landscaping projects. [www.fs.fed.us/wildflowers/](http://www.fs.fed.us/wildflowers/)
  - City of Santa Monica, Office of Sustainability and the Environment: Landscape Standards Overview. [www.smgov.net/departments/ose/](http://www.smgov.net/departments/ose/)
  - U.S. Department of Agriculture, Forest Service, Northern Research Station. Nowak, David J., Tree Planting to Improve Air Quality (2002). [www.nrs.fs.fed.us/units/urban/local-resources/downloads/Tree\\_Air\\_Qual.pdf](http://www.nrs.fs.fed.us/units/urban/local-resources/downloads/Tree_Air_Qual.pdf)
  - University of Arizona Cooperative Extension, Xeriscape Plant Listing. [cals.arizona.edu/yavapai/anr/hort/xeriscape/](http://cals.arizona.edu/yavapai/anr/hort/xeriscape/)



## 3.4

### **BASELINE**

*FOR NEW CONSTRUCTION PROJECTS*

### **BASELINE**

*FOR REHAB PROJECTS IF LAND DISTURBED IS  $\geq$  1,000 SQUARE FEET*

## **SURFACE STORMWATER MANAGEMENT**

### **RATIONALE**

Reducing or eliminating stormwater runoff through design and management techniques increases on-site filtration, reduces total suspended solids (TSS) and other pollutants from entering waterways and reduces soil erosion. From a resiliency standpoint, minimizing stormwater runoff and storm sewer flows also helps reduce downstream flooding—an important concern with more intense storms predicted in the future. Water storage and nutrient collection processes reduce the need for irrigation and contribute to forming a healthier ecological community within the landscape.

### **REQUIREMENTS**

Utilize green infrastructure practices such as permeable pavements, bioretention cells/rain gardens, rain water harvesting, green roofs, soil quality restoration and native plants to infiltrate, evapotranspire, capture and reuse the water quality volume (runoff from up to 1.25" of rain per 24 hours) to maintain or restore natural hydrologies. Green infrastructure practices utilized shall follow the design specifications, if available, in the Iowa Stormwater Management Manual. Provide owner a green infrastructure maintenance plan.

Project design teams shall consult with Iowa Department of Agriculture and Land Stewardship (IDALS) Urban Conservation Program Team on project stormwater management designs at beginning of design, 30%, 60%, 90%, and final design. Prior to going to project bid, the Recipient will secure and upload to [www.iowagrants.gov](http://www.iowagrants.gov) the Milestones Checklist (Appendix I) signed by an IDALS team member confirming stormwater management designs meet the requirements of the Iowa Stormwater Management Manual.

Have the project or site designer take and email pictures to [greenstreets@iowaeda.com](mailto:greenstreets@iowaeda.com) of installation and completion of stormwater management practices. Medians, where needed, should be seen as opportunities for installing infiltration-based green infrastructure practices. The use of raised medians is discouraged and should be avoided.

### **RECOMMENDATIONS**

- Seek out contractors that are certified Rainscapers through the Iowa Stormwater Education Partnership. [iowastormwater.org/?s=rainscaper](http://iowastormwater.org/?s=rainscaper)
- Improve the water-retention capacity of the soil by increasing the organic matter content of the soil through the addition of compost or other organic soils.
- Projects may retain precipitation volume through any combination of the following techniques: on-site infiltration, evapotranspiration, water reuse, and cisterns.



- Implement runoff-reduction strategies (e.g., biofiltration through plantings, soils). These strategies also improve water quality.
- Evaluate the discharge volumes and rates to ensure that they do not increase the natural rate of erosion in receiving waterways or negatively affect a receiving waterway’s ecological flows or natural groundwater replenishment rates and volumes.
- Implement strategies to reduce precipitation runoff volumes, peak flows, and pollutant discharges.
- Use rainwater-harvesting systems to reduce precipitation runoff volumes and rates. Design rainwater harvesting and use systems to maintain the ecological flows of receiving waters and historical groundwater recharge rates.
- Make use of innovative, low-impact techniques such as disconnected downspouts, permeable paving, swales, retention basins, rain gardens, green roof, rain barrels to convey, capture, infiltrate, and/or reuse stormwater.
- Minimize impervious areas (surfaces that do not allow stormwater infiltration), including roofs, driveways, sidewalks, and streets, or use porous materials for such areas. Water-permeable materials include pervious interlocking concrete paving blocks, concrete grid pavers, perforated brick pavers, and compacted gravel.
- Provide a visual reminder that storm sewer inlets connect to area waterways and groundwater storages, use a plaque, tile, painted, or pre-cast message such as “No Dumping. Drains to [name of water source].” If project is unable to label storm inlets due to jurisdictional constraints, the project team must provide documentation.

## RESOURCES

- Iowa Stormwater Education Partnership. [iowastormwater.org/](http://iowastormwater.org/)
- Iowa Department of Agriculture and Land Stewardship Urban Conservation Program. [iowaagriculture.gov/field-services-bureau/urban-conservation](http://iowaagriculture.gov/field-services-bureau/urban-conservation)
- Iowa Stormwater Management Manual. [www.iowadnr.gov/Environmental-Protection/Water-Quality/NPDES-Storm-Water/Storm-Water-Manual](http://www.iowadnr.gov/Environmental-Protection/Water-Quality/NPDES-Storm-Water/Storm-Water-Manual)
- U.S. Environmental Protection Agency, Storm Drain Marking. [water.epa.gov/polwaste/npdes/swbmp/Storm-Drain-Marking.cfm](http://water.epa.gov/polwaste/npdes/swbmp/Storm-Drain-Marking.cfm)
- U.S. Environmental Protection Agency, Low-Impact Development: An Integrated Design Approach. [nepis.epa.gov/Exe/tiff2png.cgi/20004JX4.PNG?-r+75+-g+7+D%3A%5CZYFILES%5CINDEX%20DATA%5C00THRU05%5CTIFF%5C00000138%5C20004JX4.TIF](http://nepis.epa.gov/Exe/tiff2png.cgi/20004JX4.PNG?-r+75+-g+7+D%3A%5CZYFILES%5CINDEX%20DATA%5C00THRU05%5CTIFF%5C00000138%5C20004JX4.TIF)
- U.S. Environmental Protection Agency, Low-Impact Development. [www.epa.gov/nps/urban-runoff-low-impact-development](http://www.epa.gov/nps/urban-runoff-low-impact-development)
- University of Arizona Cooperative Extension, Xeriscape Plant Listing. [ag.arizona.edu/yavapai/anr/hort/xeriscape/](http://ag.arizona.edu/yavapai/anr/hort/xeriscape/)
- Low Impact Development and Sustainable Stormwater Management, by Thomas Cahill, John Wiley & Sons, 2012. [www.wiley.com/en-us/Low+Impact+Development+and+Sustainable+Storm+water+Management-p-9780470096758](http://www.wiley.com/en-us/Low+Impact+Development+and+Sustainable+Storm+water+Management-p-9780470096758)
- Porous Pavements: Integrative Studies in Water Management and Land Development, by Bruce Ferguson, CRC Press, 2005.



## 3.5

### **OPTIONAL** *10 POINTS*

### **BASELINE**

*FOR IOWA GREEN STREETS CERTIFICATION PLUS*

## **SURFACE STORMWATER MANAGEMENT: CHANNEL PROTECTION VOLUME**

### **RATIONALE**

See Rationale for Criterion 3.4.

### **REQUIREMENTS**

#### ***REHAB PROJECTS DISTURBING <1,000 SQUARE FEET***

For building rehabilitation projects disturbing < 1,000 square feet, follow the requirements in Criterion 3.4

#### ***NEW CONSTRUCTION AND REHAB PROJECTS DISTURBING ≥1,000 SQUARE FEET***

Utilize green infrastructure practices such as permeable pavements, bioretention cells/rain gardens, rain water harvesting, green roofs, soil quality restoration and native plants to infiltrate, evapotranspire, capture, and reuse the channel protection volume (runoff from approximately 2.5" of rain per 24 hours) to maintain or restore natural hydrologies.

### **RECOMMENDATIONS**

See Recommendations for Criterion 3.4.

### **RESOURCES**

See Resources for Criterion 3.4.



## 3.6

### **BASELINE**

*(IF PERMANENT IRRIGATION IS UTILIZED)*

## **EFFICIENT IRRIGATION AND WATER REUSE**

### **RATIONALE**

On average, outdoor water use accounts for about 40 percent of residential water use. Native landscapes or carefully selected plantings can tolerate no irrigation once established, even in dry periods.

### **REQUIREMENTS**

Provide permanent irrigation only with reclaimed water source(s), such as harvested rainwater, greywater, air conditioning condensate, etc. Design and install an efficient irrigation system equipped with a WaterSense labeled weather-based irrigation controller (WBIC). Watering tubes for trees are allowed for an establishment period of two years. Irrigation systems already in existence onsite are grandfathered in.

### **RECOMMENDATIONS**

For grandfathered in irrigation systems, a minimum of 50 percent of the site's irrigation should reuse water from one of the following resources:

- treated greywater
- rainwater, collected from the roof or site
- water from a municipal recycled water system

Follow the Best Management Practices from the Irrigation Association, which include:

- Consider future needs such as expansion of the system to accommodate further development.
- Consider using non-potable water sources:
  - Captured rainwater
  - Reclaimed water
  - Recycled wastewater
  - Recycled greywater
  - Air-conditioner condensate
  - Blowdown water from boilers and cooling towers
  - Water treated and conveyed by a public agency specifically for non-potable uses
- Avoid the use of potable water for landscape irrigation; consider “xeriscaping,” a landscaping strategy that uses drought-resistant plants to significantly reduce or eliminate the need for irrigation.
- Design and install an efficient irrigation system equipped with a WaterSense labeled weather-based irrigation controller (WBIC). [www.epa.gov/watersense/irrigation-controllers](http://www.epa.gov/watersense/irrigation-controllers)



- Do not exceed manufacturer's sprinkler spacing recommendations.
- Design system so sprinklers operate within manufacturer recommended operating pressure.
- Use matched precipitation rate sprinklers (+/- 5 percent) within a zone.
- Size the zone control valve so that flow through the valve is within the manufacturer's stated flow range and so that pressure loss does not exceed 10% of static pressure.
- Install valves either above grade or below grade in a valve box large enough to service or access.
- Valve box location should consider safety and aesthetics of the site, along with long-term durability of the valve box.

Develop a proactive maintenance plan to ensure the integrity of the irrigation system. As the plants mature, the irrigation system may require adjustments.

## RESOURCES

- City of Santa Monica, Office of Sustainability and the Environment, Landscape Standards Overview. [www.smgov.net/Departments/OSE/Categories/Landscape/Landscape\\_Requirements.aspx](http://www.smgov.net/Departments/OSE/Categories/Landscape/Landscape_Requirements.aspx)
- American Society of Landscape Architects (ASLA). ASLA is the national professional association representing landscape architects. Their site provides information about members, products, services, publications, and events. [www.asla.org/](http://www.asla.org/)
- U.S. Environmental Protection Agency, WaterSense®. This site provides information on the EPA WaterSense labeling program for water-efficient landscape irrigation products, plus tips and recommendations for water-efficient irrigation. Follow the link to Weather- or Sensor-Based Irrigation Control Technologies for related information on high-efficiency irrigation controllers. [www.epa.gov/watersense/](http://www.epa.gov/watersense/)
- U.S. Environmental Protection Agency, Water-Smart Landscapes. This manual provides information about reducing water consumption through creative landscaping techniques. [www.epa.gov/watersense/water-smart-landscape-design](http://www.epa.gov/watersense/water-smart-landscape-design)
- American Water Works Association, WaterWiser®, The Water Efficiency Clearinghouse. This clearinghouse provides articles, reference materials and papers on all forms of water efficiency. [www.awwa.org/waterwiser/](http://www.awwa.org/waterwiser/)
- University of Arizona Cooperative Extension, Xeriscape Plant Listing. [ag.arizona.edu/yavapai/anr/hort/xeriscape/](http://ag.arizona.edu/yavapai/anr/hort/xeriscape/)
- Irrigation Association:
  - Landscape Irrigation Best Management Practices: [www.irrigation.org/IA/Advocacy/Standards-Best-Practices/Landscape-Irrigation-BMPs/IA/Advocacy/Landscape-Irrigation-BMPs.aspx](http://www.irrigation.org/IA/Advocacy/Standards-Best-Practices/Landscape-Irrigation-BMPs/IA/Advocacy/Landscape-Irrigation-BMPs.aspx)
  - Irrigation Audit Guidelines: [www.irrigation.org/IA/Resources/Technical-Resources/Irrigation-Auditing/Audit-Guidelines/IA/Resources/Audit-Guidelines.aspx](http://www.irrigation.org/IA/Resources/Technical-Resources/Irrigation-Auditing/Audit-Guidelines/IA/Resources/Audit-Guidelines.aspx)
  - Historical and current evapotranspiration (ET<sub>o</sub>) data: [www.irrigation.org/IA/Resources/Tools-Calculators/ET-Resources/IA/Resources/ET-Resources.aspx?hkey=576c5d0f-fee5-415f-b325-2ea2a95083fb](http://www.irrigation.org/IA/Resources/Tools-Calculators/ET-Resources/IA/Resources/ET-Resources.aspx?hkey=576c5d0f-fee5-415f-b325-2ea2a95083fb)





## 3.7

### **OPTIONAL**

**6 POINTS (FOR GRANDFATHERED IN IRRIGATION SYSTEMS)**

## **EFFICIENT IRRIGATION AND WATER REUSE**

### **RATIONALE**

See Rationale for Criterion 3.6.

### **REQUIREMENTS**

Projects with an existing grandfathered in irrigation system in Criterion 3.6 must meet the Baseline requirement below. For all projects, temporary irrigation to establish new trees and plantings is allowed for a period of two years.

A minimum of 50% of the site's irrigation should reuse water from one, or multiple, of the following sources:

- treated greywater
- captured rainwater, collected from the roof or site
- water from a municipal recycled water system specifically treated for non-potable uses
- air-conditioning condensate
- blowdown water from boilers and cooling towers

### **RECOMMENDATIONS**

See Recommendations for Criterion 3.6.

### **RESOURCES**

See Resources for Criterion 3.6.

“Their pride of living here, and how they take care of the building and watch out for each other; I’ve never seen anything like it.”

Partner of Enterprise Green Communities

WATER

INTRODUCTION CRITERIA  
CHECKLIST

- 1 INTEGRATIVE DESIGN
- 2 LOCATION +  
NEIGHBORHOOD FABRIC
- 3 SITE IMPROVEMENT
- 4 WATER
- 5 OPERATING ENERGY
- 6 MATERIALS
- 7 HEALTHY LIVING  
ENVIRONMENT
- 8 OPERATIONS,  
MAINTENANCE  
+ OCCUPANT  
ENGAGEMENT

APPENDIX

WATER QUALITY AND  
CONSERVATION PRACTICES  
IMPACT OUR HEALTH  
AND WELL-BEING, PROPERTY  
OPERATING EXPENSES, AND A  
LIMITED PRECIOUS RESOURCE.

## 4.1

# BASELINE WATER-CONSERVING FIXTURES

### RATIONALE

Water conservation translates into direct utility savings for tenants and building owners and lowers infrastructure costs associated with stormwater management and water treatment facilities. Reduced water pressure saves water, conserves energy and helps ensure proper operation of fixtures and appliances.

### REQUIREMENTS

#### *RESIDENTIAL*

Install water-conserving fixtures in all units and any common facilities with the following specifications:

- Toilets: WaterSense-labeled and 1.28 gpf (gallons per flush) or less, or dual-flush toilets, or pressure-assisted toilets
- Urinals: WaterSense-labeled and 0.128 gpf maximum
- Showerheads: WaterSense-labeled and 1.75 gpm (gallons per minute) or less
- Kitchen faucets: 1.8 gpm or less (WaterSense label not available)
- Lavatory faucets: WaterSense-labeled and 1.5 gpm or less

#### *NON-RESIDENTIAL*

Install water-conserving fixtures in all units and any common facilities with the following specifications:

- Toilets: WaterSense-labeled and 1.28 gpf (gallons per flush) or less, OR dual-flush toilets, OR pressure-assisted toilets 1.6 gpf maximum
- Urinals: WaterSense-labeled and 0.128 gpf maximum
- Showerheads: WaterSense-labeled and 1.75 gpm (gallons per minute) or less
- Kitchen faucets: 1.8 gpm or less (WaterSense label not available)
- Lavatory faucets: WaterSense-labeled and 0.5 gpm or less at 60 psi

#### *AND*

For all single-family homes and all dwelling units in buildings three stories or fewer, supply pressure may not exceed 60 PSI and should be controlled by pressure regulator if necessary. Piping for fire sprinkler systems is excluded from this requirement and should comply with state and local codes and regulations as well as manufacturer specifications.

## RECOMMENDATIONS

- Certain existing fixtures, such as bathroom faucets, can be retrofitted with aerators rather than be replaced to reduce water flow to the requisite level. Note that WaterSense labeled aerators are available and recommended.
- Dual-flush toilets have an average flow rate calculated and provided by the manufacturer. However, if you are not able to locate this information on the packaging, use a 2:1 ratio for low-volume flush to high-volume flush to determine the average flow rate.

For example, with a dual-flush toilet that has a 0.8 low-volume flush and a 1.6 high-volume flush, the calculation to determine the average would be:

$$\frac{(0.8 \text{ gpf} \times 2) + (1.6 \text{ gpf} \times 1)}{3} = 1.067 \text{ gpf}$$

- For senior projects, consider using single-flush toilets that meet the criterion flow rates rather than dual-flush toilets. Feedback from past Enterprise Green Communities projects suggests that senior populations may be unsure of the dual-flush technology, which may lead to difficulty in operating the toilets in an effective and appropriate way.

## RESOURCES

- Products and services that have earned the WaterSense label have been certified to be at least 20% more efficient than the baseline, without sacrificing performance. For instance, not all toilets—even high-efficiency toilets—operate equally well. Poor performance can lead to the need for multiple flushes, creating higher than anticipated water consumption. To correct for this, the EPA’s WaterSense program certifies toilets that achieve water efficiency and operational effectiveness. Information on WaterSense products and services is available at [www.epa.gov/watersense](http://www.epa.gov/watersense).
- Maximum Performance (MaP™) Testing. The MaP testing project was initiated in 2003 to test toilet models’ performance. This testing protocol simulates real-world use to help consumers identify high-efficiency toilets that not only save water but also work well. The current MaP testing report provides performance information on 470 toilet models. This site provides access to the complete listings of the tested toilets. [www.map-testing.com](http://www.map-testing.com)
- U.S. Environmental Protection Agency, WaterSense Resource Manual for Building WaterSense®. WaterSense Labeled Homes and the WaterSense Water Budget Tool, which may be used to predict project water consumption. [www.epa.gov/watersense/homes](http://www.epa.gov/watersense/homes)
- Two performance-based home modeling tools which result in a 0-100 score are: HERSH2o ([www.resnet.us/](http://www.resnet.us/)) and Water Efficiency Rating Score (WERS) ([www.wers.us/](http://www.wers.us/))

## 4.2

# OPTIONAL **BASELINE** 6 POINTS MAXIMUM FOR IOWA GREEN STREETS CERTIFICATION PLUS ADVANCED WATER CONSERVATION

### RATIONALE

Water conservation translates into direct utility savings for tenants and building owners and lowers infrastructure costs associated with stormwater management and water treatment facilities.

### REQUIREMENTS

Reduce total indoor water consumption by at least 30% compared to the baseline indoor water consumption chart below. Any new toilet, showerhead, and/or lavatory faucet that is installed in the project must be WaterSense certified, in addition to the project's total indoor water consumption meeting the minimum 30% improvement threshold.

The Enterprise Green Communities Water Calculator is available to calculate and compare your project per-person per-day indoor water consumption to the baseline water consumption chart below (adapted from: LEED v4.1 Water Use Reduction Calculator). When making your comparison, assume that the baseline project has the same type of fixtures as your project in question. For instance, if your project does not include dishwashers, do not include dishwasher water consumption in your baseline project calculation for comparison.

PERCENTAGE OF REDUCTION IN TOTAL INDOOR WATER CONSUMPTION	NUMBER OF OPTIONAL POINTS
30%	3 points
40%	4 points
50%	5 points
60%	6 points

#### BASELINE INDOOR WATER CONSUMPTION (per person per day)

FIXTURE	BASELINE FLUSH OR FLOW RATE	ESTIMATED FIXTURE USAGE	ESTIMATED WATER USAGE
Shower (per compartment)	2.5 gpm	6.15 minutes	15.4 gallons
Lavatory, kitchen faucet	2.2 gpm	5.0 minutes	11 gallons
Toilet	1.6 gpf	5.05 flushes	8 gallons
Clothes washer	8.4 WF* top loading and 4.7 WF front loading	0.37 cycles @ 3.5 ft <sup>3</sup>	13.2 gallons top loading 7.4 gallons front loading
Dishwasher	5.0 gpc standard and 3.5 gpc small	0.1 cycles	0.5 gallons standard and 0.4 gallons small

\*WF = Water Factor

### RECOMMENDATIONS

See Recommendations for Criterion 4.1.

### RESOURCES

See Resources for Criterion 4.1.

## 4.3

### **BASELINE AND OPTIONAL** *11 POINTS MAXIMUM* **WATER QUALITY**

#### **RATIONALE**

The quality of drinking water in the U.S. is regulated tightly and, according to the American Association for the Advancement of Science, remarkably safe. However, there are homes with people at high risk, vulnerable populations with frequent exposure to sources of lead. For instance, “lead-free” plumbing fixtures were permitted to contain up to 8% lead by weight until 2014. Today the allowable threshold for that label (which all new plumbing fixtures are required to achieve) is 0.25%. Lead pipes were banned in new systems in 1986, and yet, according to a study by the American Water Works Association, nearly a third of U.S. water systems still contained lead service lines in 2016. Properties that are served by private wells are particularly likely to have lead in drinking water. No level of lead exposure is safe, and exposure can lead to long-term learning and behavioral problems.

Legionnaires’ disease is less common, and most healthy people who are exposed to Legionella do not get sick. However, adults 50 years or older, current or former smokers, and people with a weakened immune system or chronic disease are at increased risk, if exposed.

Also consider the interplay between water conservation and quality—low flow fixtures may inadvertently exacerbate water quality degradation if water is allowed to age in a system and pipes are not “right-sized” to prevent excessive stagnation.

#### **REQUIREMENTS**

**Baseline for Substantial Rehabs of buildings built before 1986. Optional for all other building types.**

*[3 points]*

Replace lead service lines. Determine whether a lead service line (LSL) connects the drinking water main under the street with the building. To determine if the service line is lead, contact the utility company for guidance and inspect the line where it enters the property. See [www.lslr-collaborative.org/intro-to-lsl-replacement.html](http://www.lslr-collaborative.org/intro-to-lsl-replacement.html) for additional guidance. If an LSL is present, replace it before or while replacing the water heater. Follow American National Standards Institute (ANSI) /American Water Works Association (AWWA) C810-17 Standard when replacing the LSL. Full LSL replacement evolves elimination of lead pipe from a water main up to the interior plumbing of the building.

**Baseline for multifamily buildings with either a cooling tower, a centralized hot water system, or more than 10 stories in height.**

Develop a Legionella water management program within Criterion 8.1. Include keeping hot water above 140°F until the point of use and strategies to ensure that water does not stagnate in unused pipe sections or vacation locations.

**Optional, all project types. [8 points]**

Test water from dwelling unit faucets for water quality and remediate as indicated below. For testing bottles and instructions, contact an EPA approved lab. Find labs near you via this site, [www.epa.gov/dwlabcert/contact-information-certification-programs-and-certified-laboratories-drinking-water#state-labs](http://www.epa.gov/dwlabcert/contact-information-certification-programs-and-certified-laboratories-drinking-water#state-labs), or by calling the Safe Drinking Water Hotline at 1-800-426-4791 for the address and phone number of your state laboratory certification officer to find certified labs near you.

- Test water from dwelling unit faucets for the presence of lead. If results are above 0, install NSF/ANSI 58 or NSF/ANSI 53 filters in all units and replace these over time per manufacturer's instructions. If lead results are above 10 ppb, replace all fixtures with NSF 61 certified fixtures. Particularly recommended for rehabs of buildings built before 2014 and in all buildings served by private wells.
- In all buildings served by private wells, also test water from dwelling unit faucets for the following and remediate as indicated:
  - Nitrates. If results are above 50 mg/L (or above 11 mg/L for nitrogen), install an ion exchange or reverse osmosis water treatment system and test annually to make sure the problem is controlled.
  - Arsenic. If results are above 0.01 mg/L, follow remediation guidance from your local health department.
  - Coliform bacteria, to indicate whether or not E. coli is present. If coliform bacteria is above 0 CFU/100 mL total coliforms (including E. coli), notify all residents not to drink water unless it is boiled it for at least one minute at a rolling boil, longer if at high altitudes. Disinfect the well according to procedures recommended by your local health department. Monitor your water periodically after disinfection to make certain that the problem does not recur. If the contamination is a recurring problem, investigate the feasibility of drilling a new well or install a point-of-entry disinfection unit, which can use chlorine, ultraviolet light. or ozone.

**RECOMMENDATIONS**

- Some water utilities and municipalities offer financial incentives for replacing lead service lines; check with your local agencies.
- For all properties—new construction as well as rehab—ensure that water is flushed regularly, rather than risking long periods of time between when water enters the system and when it is used. When water stagnates, quality may degrade considerably. As water ages in a system, disinfectant residual will decay, reducing chlorine residuals. This may lead to increased corrosion in copper and lead pipes and increased microbial regrowth, including Legionella. The less that water is allowed to age in a system, whether through thoughtful plumbing system design and/or flushes with municipal water, the less likely these issues are to occur. Note that each tap in the property will have a different stagnation rate, depending on use, and a different risk profile, depending on pipe and fixture materials. Consider design and testing carefully for each use of water in the property.
- All community water systems prepare a Consumer Confidence Report for their customers by July 1 of each year. Contact your water utility to receive a copy of their latest report. [www.epa.gov/ccr](http://www.epa.gov/ccr)
- Install and regularly replace individual filtration systems.
- 13% of the U.S. population receives drinking water from private wells and are not required by federal or state government to remediate quality issues if found, if those wells serve fewer than 100 people. See the National Center for Water Quality Research for guidelines. <https://ncwqr.org/water-testing/well-water-testing/>

## RESOURCES

- U.S. Environmental Protection Agency, National Primary Drinking Water Regulations. [www.epa.gov/ground-water-and-drinking-water/national-primary-drinking-water-regulations](http://www.epa.gov/ground-water-and-drinking-water/national-primary-drinking-water-regulations)
- Find National Science Foundation filters for reducing lead levels: [info.nsf.org/Certified/DWTU/listings\\_leadreduction.asp?ProductFunction=053%7cLead+Reduction&ProductFunction=058%7cLead+Reduction&ProductType=&submit2=Search](http://info.nsf.org/Certified/DWTU/listings_leadreduction.asp?ProductFunction=053%7cLead+Reduction&ProductFunction=058%7cLead+Reduction&ProductType=&submit2=Search)
- Water Filtration Database, Building Clean. An initiative of BlueGreen Alliance Foundation, with various resources created for the affordable housing community. The Water Filtration Database enables searches of 450+ water filters by contaminant filtered and the point-of-use application (below counter, countertop, pitcher, and faucet-mounted). [buildingclean.org/building/products/water-filtration](http://buildingclean.org/building/products/water-filtration)
- Purdue University, Center for Plumbing Safety. Designed to provide information to people who drink water in buildings, as well as building construction, plumbing, water utility, education, and public health sectors. [engineering.purdue.edu/PlumbingSafety](http://engineering.purdue.edu/PlumbingSafety)
- Virginia Tech. Recent research on preventing potential unintended negative water quality impacts through water conservation. [aceee.org/sites/default/files/pdf/conferences/hwf/2017/Rhoads\\_Session3D\\_HWF17\\_2.27.17.pdf](http://aceee.org/sites/default/files/pdf/conferences/hwf/2017/Rhoads_Session3D_HWF17_2.27.17.pdf) and [aceee.org/sites/default/files/pdf/conferences/hwf/2017/Rhoads\\_Session2D\\_HWF17\\_2.27.17.pdf](http://aceee.org/sites/default/files/pdf/conferences/hwf/2017/Rhoads_Session2D_HWF17_2.27.17.pdf)
- Michigan State University Extension Service, Guidelines on testing for water quality. [www.canr.msu.edu/news/testing\\_drinking\\_water\\_for\\_lead\\_in\\_homes](http://www.canr.msu.edu/news/testing_drinking_water_for_lead_in_homes)
- National Survey of Lead Service Line Occurrence, Journal of the American Water Works Association. [awwa.onlinelibrary.wiley.com/doi/abs/10.5942/jawwa.2016.108.0086](http://awwa.onlinelibrary.wiley.com/doi/abs/10.5942/jawwa.2016.108.0086)
- Drexel University. Project understanding the interplay between water conservation and water quality, evaluating the impacts of new technologies, and new operational strategies. [building-water.org/](http://building-water.org/)
- Lead Service Line Replacement Collaborative. A joint effort of 27 national public health, water utility, environmental, labor, consumer, housing, and state and local governmental organizations to accelerate full removal of the lead pipes providing drinking water to millions of American homes. Includes an online toolkit to help communities voluntarily develop and implement lead service line removal programs. [www.lslr-collaborative.org/](http://www.lslr-collaborative.org/)
- American Association for the Advancement of Science, Lead in U.S. Drinking Water. Excellent overview of the lead problem, health effects, and rules, regulations, and resources. [www.sciline.org/evidence-blog/lead-drinking-water](http://www.sciline.org/evidence-blog/lead-drinking-water)
- Centers for Disease Control and Prevention, Lead: [www.cdc.gov/nceh/lead/](http://www.cdc.gov/nceh/lead/)
- Centers for Disease Control and Prevention, Legionella: [www.cdc.gov/legionella/about/causes-transmission.html](http://www.cdc.gov/legionella/about/causes-transmission.html)  
ASHRAE Standard 188: [www.ashrae.org/technical-resources/bookstore/ansi-ashrae-standard-188-2018-legionellosis-risk-management-for-building-water-systems](http://www.ashrae.org/technical-resources/bookstore/ansi-ashrae-standard-188-2018-legionellosis-risk-management-for-building-water-systems)
- Private Well Class. A free program that uses a combination of online and in-person methods to boost knowledge and competence of the individual well owner as well as the thousands of dedicated environmental health, cooperative extension and water well professionals who serve well owners day to day. The program is a collaboration between the Rural Community Assistance Partnership (RCAP) and the Illinois State Water Survey at the University of Illinois Urbana-Champaign, with funding from the U.S. Environmental Protection Agency. [privatewellclass.org/](http://privatewellclass.org/)
- RCAC. Supports rural communities through financing, trainings and TA on water infrastructure issues, including compliance with the Safe Drinking Water Act and Clean Water Act. [www.rcac.org/](http://www.rcac.org/)



- 
- The California Department of Water Resources, Wells. Provides guidance on well construction.  
<https://water.ca.gov/Programs/Groundwater-Management/Wells>
  - U.S. Environmental Protection Agency, Potential Well Water Contaminants and their Impacts.  
[www.epa.gov/node/83209/view](http://www.epa.gov/node/83209/view)
  - U.S. Environmental Protection Agency, Arsenic in your Drinking Water:  
<https://nepis.epa.gov/Exe/ZyPDF.cgi?Dockey=60000E1E.txt>  
and Arsenic in Drinking Water Point-of-Use and Point-of-Entry Treatment:  
<https://cfpub.epa.gov/safewater/arsenic/arsenicradeshow/arsenic.cfm?action=Point-of-Entry>

## 4.4

### **OPTIONAL** **4 POINTS**

# MONITORING WATER CONSUMPTION AND LEAKS

## **RATIONALE**

In some cases, leaks may be the largest driver of project water consumption. Properly installed water-using fixtures, equipment, and appliances should not leak. However, over time, leaks may occur and should be resolved.

Monitoring water consumption by fixture, dwelling unit, or riser allows more nuanced understanding and management of water consumption than the typical whole-building meter.

## **REQUIREMENTS**

Conduct pressure-loss tests and visual inspections to determine if there are any leaks; fix any leaks found. Visual inspections shall include checking for leaks at all accessible, visible water supply connections, and valves for water-using fixtures, appliances, and equipment.

Install an advanced water monitoring and leak detection system capable of identifying and shutting water off during anomalous water use events, or install a device to separately monitor water consumption in each of the following areas of the project:

- Choose one from these three options:
  - A cold branch off the apartment line riser for each dwelling unit
  - A cold-water riser and domestic hot water/cold water feed for each building
  - Every toilet in the project has technology that allows remote monitor readings
- Common project laundry facilities, if such facilities exist
- Boiler makeup water, if such boiler exists
- Outdoor water consumption
- Water consumption in any non-residential spaces of the project, where the property owner is responsible for water utilities

## RECOMMENDATIONS

- Note that for single-family homes with only one water supply to the home, the inspector will attach a pressure gauge to an outside faucet, take a reading and then shut off the municipal water supply to the house. After several minutes, the inspector will determine if the pressure has dropped. A loss of pressure indicates an unseen leak. For homes with more than one water supply or without an outdoor faucet, inspectors will attach a pressure gauge to the cold-water faucet for the washing machine hookup or other cold-water faucet and take the pressure reading. Conducting a pressure-loss test on dwelling units in multifamily buildings will vary based on the plumbing system design.

Dwelling units that are supplied through a single line with a shut-off can be tested at any point of use. The pressure loss test can most easily be done here at a washer hookup or at any fixture using an adapter. For buildings that use riser pipe layouts, the test is simplest at the whole building level.

- As a first step, when designing the plumbing system for a multifamily building, consider supplying each unit with a single pipe source and stubbing out for a meter to facilitate individual unit submetering. This will reduce costs associated with having to install multiple meters/monitors for several points of use attached to a single riser pipe.
- When selecting equipment that is best suited for accurately measuring water use in each unit, note that water use within individual units will fluctuate between low and peak flows depending on the unit's occupancy and the time of day. We recommend positive displacement meters but consult with the meter or monitor manufacturer to select an appropriately sized device for the application. The building's and the individual units' size, function, fixture types, usage, occupancy, and peak population will influence minimum and maximum flow rates and proper sizing.
- Note that improper installation can lead to metering/monitoring inaccuracies. In general, we recommend installing meters and/or monitors in an accessible location to allow for reading and repair and in a location protected from potential damage. And, to ensure uniform flow entering and exiting the meter or monitor, we recommend locating the monitoring device where there is sufficient length of straight pipe before and after the device. Consider installing a strainer to prevent debris and sediment from entering the meter/monitor and causing reading inaccuracies.
- We recommend that in-line meters or monitors meet AWWA standards and include a pulse output (1 pulse per gallon is desirable). Note that some vendors package water monitors with a remote data monitoring system. Other vendors offer only monitors or only remote data monitoring systems; these may be paired. And note that remote data monitoring systems come in a variety of forms: some are wireless and others require that they be hard-wired. With either type, typically the water consumption data is sent from each meter/monitor to a datalogger inside the building, which passes it on to a website where it can be reviewed and downloaded. In cases where staff do not have time to review data for dozens of submeters/monitors, the website can be programmed to send out a text or email alarm when a leak is suspected. Because it is easy to set up alarms, it is not necessary to dedicate an employee or outside firm to monitor the water data, but it is desirable and should be considered. We recommend consulting with the property owner and operations staff to determine whether a remote monitoring system is appropriate for the property.

- Note that in-line meters/monitors should be installed by a licensed plumber. We recommend a press-it pipe joining system instead of sweated joints for these installations, if also allowed by the manufacturer. Such a system saves labor costs and permits otherwise impossible installations. Remote data-gathering systems are often installed by a controls or telecom contractor or, more expensively, by a licensed electrician. We recommend care in ensuring that every meter/monitor is installed so that it may be easily accessed for repairs or for manual reading (should that become necessary)—meters/monitors in cramped or inaccessible locations frequently are ignored or forgotten. Experience shows that domestic water systems frequently include long pipe runs without any shut-off capability, which make future repairs more difficult and/or disruptive. We recommend installing a few extra well-placed isolation valves. Similarly, in new construction in particular, we recommend designers prioritize placing pipes in accessible locations when possible, either by exposing them or placing them behind an easily removable access door or chase. Pipes in an easily removable chase are generally easier to repair and inspect and may be isolatable enough to eliminate water damage from a pipe burst or joint leak. We also recommend considering additional electrical outlets in basements to allow for the installation of the data gathering system described here.

## RESOURCES

- Alliance for Water Efficiency, Submetering Introduction, 2010. [www.allianceforwaterefficiency.org/submetering.aspx](http://www.allianceforwaterefficiency.org/submetering.aspx)
- American Water Works Association, Information and articles on submetering. [www.awwa.org](http://www.awwa.org)
- California Apartment Association, Articles on submetering. [www.caanet.org](http://www.caanet.org)
- California Water Efficiency Partnership, Articles on submetering. [calwep.org/](http://calwep.org/)
- U.S. Environmental Protection Agency, WaterSense labeled New Homes. [www.epa.gov/watersense/new\\_homes/](http://www.epa.gov/watersense/new_homes/)

## 4.5

### OPTIONAL 4 POINTS

# EFFICIENT PLUMBING LAYOUT AND DESIGN

## RATIONALE

Efficiently designed hot water delivery systems reduce the amount of time it takes hot water to reach a fixture, saving both water and energy. Approximately 10%–15% of the energy use associated with the hot water delivery system is wasted in distribution losses, waiting for hot water to arrive at the point of use.

## REQUIREMENTS

To minimize water loss from delivering hot water, the hot water delivery system shall store no more than 0.5 gallons of water in any piping/manifold between the fixture and the water heating source or recirculation line.

To account for the additional water that must be removed from the system before hot water can be delivered, no more than 0.6 gallons of water shall be collected from the fixture before a 10°F rise in temperature is observed.

Recirculation systems must be demand-initiated. Systems that are activated based solely on a time and/or temperature sensor do not meet this requirement.

Ensure that your project is still meeting all relative local codes and requirements. Codes such as the 2018 Universal Plumbing Code and 2017 WE-Standard employ “right-sized” plumbing techniques that supersede and automatically comply with this requirement.

## RECOMMENDATIONS

- Effective and efficient distribution of hot water requires a whole-system approach and can be challenging to many builders. Considering the hot water delivery system early in the design phase and carefully following a plumbing design can deliver superior homes and reduced installation costs.
- A hot water distribution system with less stored water in its piping will waste less water and energy. The length of piping between the water heater and each fixture, the pipe diameter, and piping material can all have a great cumulative impact on the efficiency of hot water delivery.
- Insulation of hot water pipes can improve the efficiency of a hot water distribution system. Insulation of hot water pipes reduces the rate of heat loss and can deliver water that is 2°F to 4°F hotter than uninsulated pipes can. Pipe sleeves made with polyethylene or neoprene foam with thicknesses of either ½ or ¾ inch are the most commonly used insulation. The pipe sleeve inside diameter should match the diameter of the pipe for a close fit. Securing insulation every one to two feet using tape, wire, or cable tie will also help to fit insulation close to the pipe. Insulation should be used along the entire length of hot water pipes, including elbows and joints, but should be kept 6 inches away from the flue of gas water heaters. Insulation performs better with an R-value of R-3.0 or greater.
- Consider central core plumbing, and/or multiple stacked central core plumbing layout, locating the water heater very close to hot water fixtures. Avoid dead legs at all costs.

---

## RESOURCES

- U.S. Environmental Protection Agency, Report an Environmental Violation, Hot Water Volume Tool. This editable tool allows project teams to design their plumbing system with a variety of materials to minimize waste in delivery.  
[www.epa.gov/sites/production/files/2017-02/ws-homes-hot-water-volume-tool.xlsm](http://www.epa.gov/sites/production/files/2017-02/ws-homes-hot-water-volume-tool.xlsm)
- U.S. Environmental Protection Agency, WaterSense Labeled New Homes—Hot Water Delivery Systems. [www.epa.gov/watersense/watersense-labeled-homes-hot-water](http://www.epa.gov/watersense/watersense-labeled-homes-hot-water)
- U.S. Environmental Protection Agency, Guide for Efficient Hot Water Delivery Systems.  
[www.epa.gov/sites/production/files/2017-01/documents/ws-homes-hot-water-distribution-guide.pdf](http://www.epa.gov/sites/production/files/2017-01/documents/ws-homes-hot-water-distribution-guide.pdf)
- Plumbing Systems & Design, Hot-Water Distribution Systems Part 1, Gary Klein, Mar/Apr 2004.

## 4.6

### OPTIONAL 6 POINTS MAXIMUM

## NON-POTABLE WATER REUSE

### RATIONALE

Rainwater and greywater reuse strategies reduce the need for municipal water supplies and sewage treatment. This is also an important resilience strategy, as it offers some level of protection and stability against drought or interruptions in water supply.

### REQUIREMENTS

Harvest, treat, and reuse rainwater and/or greywater to meet a portion of the project's non-potable water needs. Install backflow preventers or other methods of cross-connection protection at any junctions with the greywater systems.

To achieve optional points, provide the defined percentage of the project's non-potable water needs which will not be met with a potable water source—instead, through rainwater and/or greywater.

TOTAL NON-POTABLE WATER NEEDS SUPPLIED BY NONPOTABLE SOURCES (RAINWATER AND/OR GREYWATER)	NUMBER OF OPTIONAL POINTS
10%	3 points
20%	4 points
30%	5 points
40%	6 points

### RECOMMENDATIONS

- Work closely with local and state public health officials on system design for harvested water reuse in buildings.
- In some cases, employing rainwater and greywater harvesting, treatment and reuse can provide all a project's water needs. However, use is subject to state and local regulations and special requirements, and in some jurisdictions these systems may not be allowed. Check with your local building code officials for requirements.
- Non-potable water recommended for residential application can be provided by harvested rainwater using rain barrels or cisterns or by obtaining reclaimed water from the municipality. Rainwater and reclaimed water do not meet potable water standards and therefore have limited use applications. These water sources can supply water for non-spray irrigation and other outdoor water needs during periods of drought but are never suitable for human consumption. Proper signage should be displayed on the structure to caution users that the water source is non-potable.
- Rainwater can be harvested from impervious surfaces such as roofs and carried via gutters and downspouts to a storage tank or cistern where it can be treated or filtered for potable uses. Untreated rainwater may be used for non-potable uses.
- Greywater may be stored and treated for non-potable uses such as toilet flushing and irrigation.

---

## RESOURCES

- CSA B805/ICC 805, Rainwater Harvesting Systems. Applies to the design, installation, and operation of rainwater harvesting systems for potable and non-potable applications. [shop.iccsafe.org/csa-b805-18-icc-805-2018-rainwater-harvesting-systems.html](http://shop.iccsafe.org/csa-b805-18-icc-805-2018-rainwater-harvesting-systems.html)
- The San Francisco Rainwater Harvesting Manual. Offers design and operations guidance for non-potable residential uses. [www.sfwater.org/Modules/ShowDocument.aspx?documentID=8897](http://www.sfwater.org/Modules/ShowDocument.aspx?documentID=8897)
- American Water Works Association, WaterWiser®: The Water Efficiency Clearinghouse. This clearinghouse provides articles, reference materials, and papers on water recycling, greywater, and rainwater reuse. [www.awwa.org/waterwiser/](http://www.awwa.org/waterwiser/)
- International Living Building Institute, Achieving Water Independence in Buildings. This downloadable publication explains water reuse systems and regulatory barriers and provides information for those wishing to explore the possibilities of water reuse in buildings and to reform limiting regulation. [living-future.org/wp-content/uploads/2016/11/Achieving\\_Water\\_Independence\\_in\\_Buildings.pdf](http://living-future.org/wp-content/uploads/2016/11/Achieving_Water_Independence_in_Buildings.pdf) as well as <https://living-future.org/research/>



## 4.7

### OPTIONAL 8 POINTS

# ACCESS TO POTABLE WATER DURING EMERGENCIES

## RATIONALE

During power outages, access to water for drinking and sanitation needs is often one of the greatest challenges. During a power failure, buildings using electric pumps lose their supply of potable water.

## REQUIREMENTS

Provide residents/building occupants with ready access to potable water in the event of an emergency that disrupts normal access to potable water. Choose one of the following options:

### *Option 1*

In buildings where on-site electrical pumps are used to transport water to upper floors, provide tenants with access to potable water at a location where containers can be filled and brought to apartments/offices. Ensure that this access point is located above flood level and that it may be accessed safely and relatively easily in times of power loss (e.g., a public restroom on a lower floor).

OR

### *Option 2*

Provide stored potable water that can be used during times of emergency totaling 10 gallons per resident/occupant per day for a minimum of four days. Note potability as well as storage size and weight considerations.

OR

### *Option 3*

Provide a drilled well with a means for pumping water when the electric grid is down (e.g., hand pump, portable generator serving pump, gravity-flow spring).

## RECOMMENDATIONS

- In many cities, pressure typically brings water up to the fifth or sixth floor of taller buildings, with pumps used to deliver water to higher floors. If the power grid fails and backup generators are not connected to water pumps or if they fail, tenants should have access to a place in a common room to fill containers with potable water. This could be a centrally accessible corridor or utility closet. Specifics will vary by project.
- In more rural areas that rely on on-site water rather than municipal water, advanced, modern hand pumps can provide a resilient water supply.
- Harvested rainwater or pumped water can be stored on top of buildings, in utility space in buildings, or in separate water tanks.
- For properties that use roof-top tanks to maintain pressure, it may be possible to utilize these tanks as a source during emergencies with proper controls and access.

“Being able to afford your bills ... as you grow older, this becomes more and more important.”

Resident of Enterprise Green Communities property

## RESOURCES

- NYC Building Resiliency Task Force Report. [http://urbangreencouncil.org/sites/default/files/2013\\_brtf\\_fullreport.pdf](http://urbangreencouncil.org/sites/default/files/2013_brtf_fullreport.pdf)
- Enterprise Green Communities, Ready to Respond Toolkit. Includes more than a dozen strategies and specific guidance for building property resilience in the event of an emergency, including access to potable water. [www.enterprisecommunity.org/resources](http://www.enterprisecommunity.org/resources)

## OPERATING ENERGY

INTRODUCTION CRITERIA  
CHECKLIST

- 1 INTEGRATIVE DESIGN
- 2 LOCATION +  
NEIGHBORHOOD FABRIC
- 3 SITE IMPROVEMENT
- 4 WATER
- 5 OPERATING ENERGY
- 6 MATERIALS
- 7 HEALTHY LIVING  
ENVIRONMENT
- 8 OPERATIONS,  
MAINTENANCE  
+ OCCUPANT  
ENGAGEMENT

## APPENDIX

ALONG THE “PATH TO ZERO,”  
REDUCING THE AMOUNT  
OF ENERGY REQUIRED TO  
OPERATE THE BUILDING  
AND MOVING TO CLEAN  
ENERGY SOURCES PROVIDES  
ENVIRONMENTAL BENEFITS,  
IMPROVES CONDITIONS  
FOR RESIDENT HEALTH AND  
COMFORT, AND IMPACTS  
PROPERTY OPERATING  
EXPENSES.

# 5.1

## BASELINE BUILDING PERFORMANCE REQUIREMENTS

### RATIONALE

To achieve high-performance building construction, lower operating costs, quality indoor air, and improved comfort; attention to detail and building science best practices must be applied in concert with high quality equipment.

### REQUIREMENTS

All project types covered by Criterion 5.1a – 5.1d shall follow the building performance requirements below:

- Energy Performance Ratings;
- Air Barrier and Insulation Inspection Component Guide;
- Energy Performance Table;
- Thermal Envelope;
- Insulation;
- Windows, Doors, Water Heaters, Ventilation;
- Lighting;
- Sampling Protocol; and
- High Performance Construction Best Practices (see Appendix G – Air Sealing Key Points)

### ENERGY PERFORMANCE RATINGS

ITEM	MINIMUM REQUIRED
Residential New Construction	Home Energy Rating System (HERS) Index $\leq$ 61, (HERS) Index $\leq$ 56 required for Disaster Recovery Housing Projects.
Residential Substantial Rehabilitation	HERS Index $\leq$ 80, HERS Index $\leq$ 100 if building was built before 1980 and walls are made only of brick/masonry.
Residential Moderate Rehabilitation	HERS Index $\leq$ 80, HERS Index $\leq$ 100 if building was built before 1980.
Commercial New Construction	Projects must exceed the performance of the current state of Iowa adopted Energy Code at the time of local submittal for plan review by at least 10 percent.
Commercial Substantial Rehabilitation	Projects must exceed the performance of the current state of Iowa adopted Energy Code at the time of local submittal for plan review by at least 10 percent.
Commercial Moderate Rehabilitation	Projects must exceed the performance of the current state of Iowa adopted Energy Code at the time of local submittal for plan review.

ITEM	MINIMUM REQUIRED
Residential and Commercial Mixed-Use Buildings	<p>Residential units must meet applicable residential requirements above and rest of Criterion 5.1-5.1d.</p> <p>Commercial area of the project must meet the applicable commercial building requirements above and rest of Criterion 5.1-5.1d</p> <p>Projects greater than 100,000 cubic feet of heated or cooled interior space must complete the Iowa required Energy Review Form identified in Code of Iowa chapter 103A.19(6).</p>

### **AIR BARRIER AND INSULATION INSPECTION COMPONENT GUIDE**

COMPONENT	CRITERIA
Air barrier and thermal barrier	Exterior thermal envelope insulation for framed walls is installed in substantial contact and continuous alignment with building envelope air barrier. Breaks or joints in the air barrier are filled or repaired. Air-permeable insulation is not used as a sealing material.
Ceiling	Air barrier in any dropped ceiling/soffit is substantially aligned with insulation and any gaps are sealed.
Walls	Corners and headers are insulated; junction of foundation and sill plate is sealed.
Windows and doors	Space between window/door jambs and framing is sealed. No stuffing of fiberglass insulation is allowed.
Rim joists	Rim joists are insulated and include an air barrier following included reference to best practice example.
Floors (including above-garage cantilevered floors)	Insulation is installed to maintain permanent contact with the area it is. Insulating Air barrier is installed at any exposed edge of insulation
Crawl space walls	Insulation is permanently attached to walls. No poly or vinyl faced insulation. Follow included reference to best practice example. Exposed earth in unvented crawl spaces is covered with Class I vapor barrier with overlapping joints taped.
Shafts, penetrations	Duct shafts, utility penetrations, knee walls, and flue shafts opening to exterior or unconditioned spaces are sealed.
Narrow cavities	Batts in narrow cavities are cut to fit, or narrow cavities are filled with sprayed/blown insulation. Narrow cavities are defined as 4 inches wide or less.
Garage separation	Air sealing is provided between the garage and conditioned spaces and door assembly meets fire code.
Recessed lighting	Recessed light fixtures are airtight, ICAT rated, & sealed to drywall. Exception—fixtures in conditioned space. Use LED flush mount lighting instead of recessed fixtures.
Plumbing and wiring	Insulation is placed between the exterior wall and the pipes.  Batt insulation is cut to fit around wiring and plumbing, or sprayed/blown insulation extends behind piping and wiring
Shower/tub exterior wall	Showers and tubs on exterior walls have insulation and an air barrier separating them from the exterior wall

COMPONENT	CRITERIA
Electrical/phone box	Air barrier extends behind boxes or air-sealed-type boxes are installed on exterior walls
Common wall	Air barrier is installed in common wall between dwelling units and air infiltration is treated like an exterior wall. Common walls need to be considered as an exterior wall for air sealing.
HVAC register boots	HVAC register boots that penetrate building envelope are sealed to subfloor or drywall.
Attic Doors & Hatches (from conditioned to unconditioned spaces)	Attic access (except unvented attic), knee-wall door, or drop-down stair is insulated and sealed or in conditioned space. Gasketed/barrier of a minimum of 18" tall/minimum of R-40 rigid foam on scuttle top. Must include fire rated assembly.
Fireplace	Fireplace walls include an air barrier. Wood-burning fireplaces shall have gasketed doors & outdoor combustion air/insulated/blocked & sealed.

### ENERGY PERFORMANCE TABLE

ITEM	MINIMUM REQUIRED
Cooling	Proper Sizing (Manuals D, J, & S Required) – matched to code and using modeling software appropriate to project type – commercial/residential. Modeling must be completed by ACCA approved software. Use current addition (not including spreadsheets and abridged versions) – <a href="http://www.acca.org/standards/approved-software">www.acca.org/standards/approved-software</a> . Seek out ENERGY STAR Most Efficient recognized equipment.
Electric, Forced-air, central air conditioners	16 SEER/EER 13.0
Electric, Forced-air, air-source heat pumps	16 SEER/EER 13.0
Electric, ground-source heat pumps (closed loop)	18 EER
Electric, ground-source heat pumps (open loop)	18 EER
Mini-Split Heat Pump	15 SEER/EER 12.5/HSPF 8.5
Heating	Proper Sizing (Manual D, J & S Required) - Seek out ENERGY STAR Most Efficient recognized equipment.
Natural gas, forced-air furnaces	96 AFUE
Natural gas, boilers	90 AFUE
Electric, Forced-air, air-source heat pumps	9 HSPF
Electric, ground-source heat pumps (closed loop)	4 COP
Electric, ground-source heat pumps (open loop)	4 COP
Ground-source heat pump & boiler piping insulation	Insulated to a minimum of R-3



ITEM	MINIMUM REQUIRED
HVAC System Performance	Complete/pass current version of ENERGY STAR Certified Homes or MFNC HVAC System Quality Installation Contractor Checklist and ENERGY STAR Certified Homes HVAC System Quality Installation Rater Checklist. For commercial projects utilize commissioning agent to develop a commissioning plan appropriate for the building systems designed for the project.
HVAC Installation Space	HVAC equipment needs to be installed in an easily accessible space for maintenance and repair.
Thermostat	Install a programmable communicating thermostat (Smart Thermostat). A whole building or dwelling unit thermostat that can be monitored and controlled remotely. The thermostat shall include the capability to set back or temporarily operate the system and provide remote access to maintain zone temperatures of not less than 55°F to not greater than 85°F. Digital control system can be utilized for commercial systems and coordinated with commissioning plan.
Ductwork – Sheet metal ducts (supply & return) and joints – insulated to R-8 in unconditioned spaces/sealing each joint using mastic and/ or UL 181 approved tapes or sealants	All ductwork should be installed in conditioned spaces. If ductwork is located outside conditioned space, then ductwork shall be tested for 4% or less tested duct leakage to unconditioned spaces.

### ***THERMAL ENVELOPE***

ITEM	MINIMUM REQUIRED
Thermal Envelope	Infiltration levels must be equal to or less than 3 ACH50 determined by using a blower door test. The project must pass a thermal bypass inspection checklist performed by a third-party Energy Rater certified by RESNET or Building Performance Institute. The following must be sealed & or blocked with an air barrier: All joints, seams & penetrations/windows, doors & skylights/openings between window & door assemblies & jambs & framing/utility penetrations/dropped ceiling or chases adjacent to the thermal envelope/knee walls/walls & ceilings between units/attic access openings/rim joist junction/other sources of infiltration (must use rigid blocking). For knee walls, follow prescriptive energy code or Energy Star guidance if knee wall is 1' or less. For commercial projects include envelope commissioning in the commissioning agent's scope and written plan

## INSULATION

ITEM	MINIMUM REQUIRED
Ceiling	R-49 – Raised Heel Truss with minimum 14” heel height. For commercial projects and residential projects with low-sloped “flat” roofs, roof/ceiling assemblies shall be insulated above the sheathing/decking to eliminate need for ceiling cavity insulation.
Wood Frame Wall	Zone 5 = Minimum of R-13 cavity + R-5 continuous rigid exterior foam. Zone 6 = Minimum of R-20 cavity  + R-5 or R-13 cavity + R-10 continuous rigid exterior foam insulation.
Mass Frame Wall	Zone 5 = R-13/17, Zone 6 = R-15/20
Floor, above unheated space	Minimum R-30 (must fill cavity depth)
Basement Wall (entire)	Zone 5 & 6 = R-15/19
Rim Joist	R-19 + 5 continuous rigid exterior foam
Slab Edge Insulation	For slabs on grade in CZ4-8, 100% of slab edge insulated to $\geq$ R-5 at the depth specified by the 2009 IECC and aligned with the thermal boundary of the walls.
Under Slab Insulation	For under slab insulation install a minimum of R-10 of rigid foam under at least the outer 4’ of slab perimeter and minimum of R-5 under rest of slab. Include capillary break and vapor barrier as detailed in criterion 6.8.
Crawl Space	R-15 continuous/R-19 cavity (must be conditioned / crawl space floor covered with minimum 10 mil poly)
Thermally Isolated Sunrooms	Min. R-24 in ceilings/min. R-13 in side walls

## WINDOWS, DOORS, WATER HEATERS, VENTILATION

ITEM	MINIMUM REQUIRED
Windows ENERGY STAR (must have NFRC sticker for residential windows)	$U \leq 0.27$ / SHGC any; $U = 0.28$ / SHGC $\geq 0.32$ ; $U = 0.29$ / SHGC $\geq 0.37$ ; $U = .30$ / SHGC $\geq 0.42$
Doors	R-5
Water Heaters	Water heater needs to be installed in an easily accessible space for maintenance and repair. Natural gas water heaters must be power vented.
Natural gas, up to 60 gallons	.67 EF and ENERGY STAR qualified
Natural gas, 60-80 gallons	.85 TE and ENERGY STAR qualified
Natural gas tankless	.82 EF and ENERGY STAR qualified
Natural gas condensing	90% TE and ENERGY STAR qualified
Electric	.95 EF and ENERGY STAR qualified
Electric Heat Pump	2.0 EF or greater and ENERGY STAR qualified
Hot Water Piping	Hot water piping shall be insulated to a minimum of R-3 or per state of Iowa adopted version of the International Energy Conservation Code, whichever is more stringent.
Mechanical Ventilation	Required to be balanced and tested to meet current edition of ASHRAE 62.2 (residential), ASHRAE 62.1 (commercial)





## **LIGHTING**

ITEM	MINIMUM REQUIRED
Recessed Lighting	Shall be sealed & ICAT-rated & labeled to meet ASTM E 283 & gasketed. Use LED flush mount lighting instead of recessed fixtures.
High-Efficiency Lamps	All lighting shall be LED.

## **SAMPLING PROTOCOL**

Sampling of units is allowed per Residential Energy Services Network (RESNET) technical requirement section 602. Units can be sampled in groups of seven. Sample groups (sets) are comprised of units at the same stage of construction (i.e., pre-drywall, final inspection) within 30 days of each other.

In order to qualify for sample testing, seven units must be inspected without incidence of failure, otherwise referred to as the qualifying sample set. Following the sample testing, remaining units are tested one in seven (one tested unit representing six untested or sampled units).

Managing Failures: Initial failures are managed by testing an additional two units in the sample set. Following this, if additional failures occur in one of two of those additional units the remainder of the sample set or group must be tested. If three additional failures occur within a 90-day period, 100% of that inspection type will need inspection for a minimum of seven units (ex. failure in blower door testing, etc.). Alternatively, the builder may conduct and submit a root cause analysis to determine a solution to resume sampling procedures.

Thermal inspections cannot be sampled. Every unit must receive an inspection to ensure the thermal enclosure, air barrier and insulation criteria have been achieved. This is to be verified by the third-party energy rating firm using the current ENERGY STAR “Thermal Enclosure System Rater Checklist.”

### HIGH PERFORMANCE CONSTRUCTION BEST PRACTICES

The following images are provided as recommended best practices to achieve a high-performance energy envelope that will assist the project meeting the energy performance requirements listed above. See additional images for best practices for air sealing key points in Appendix G.

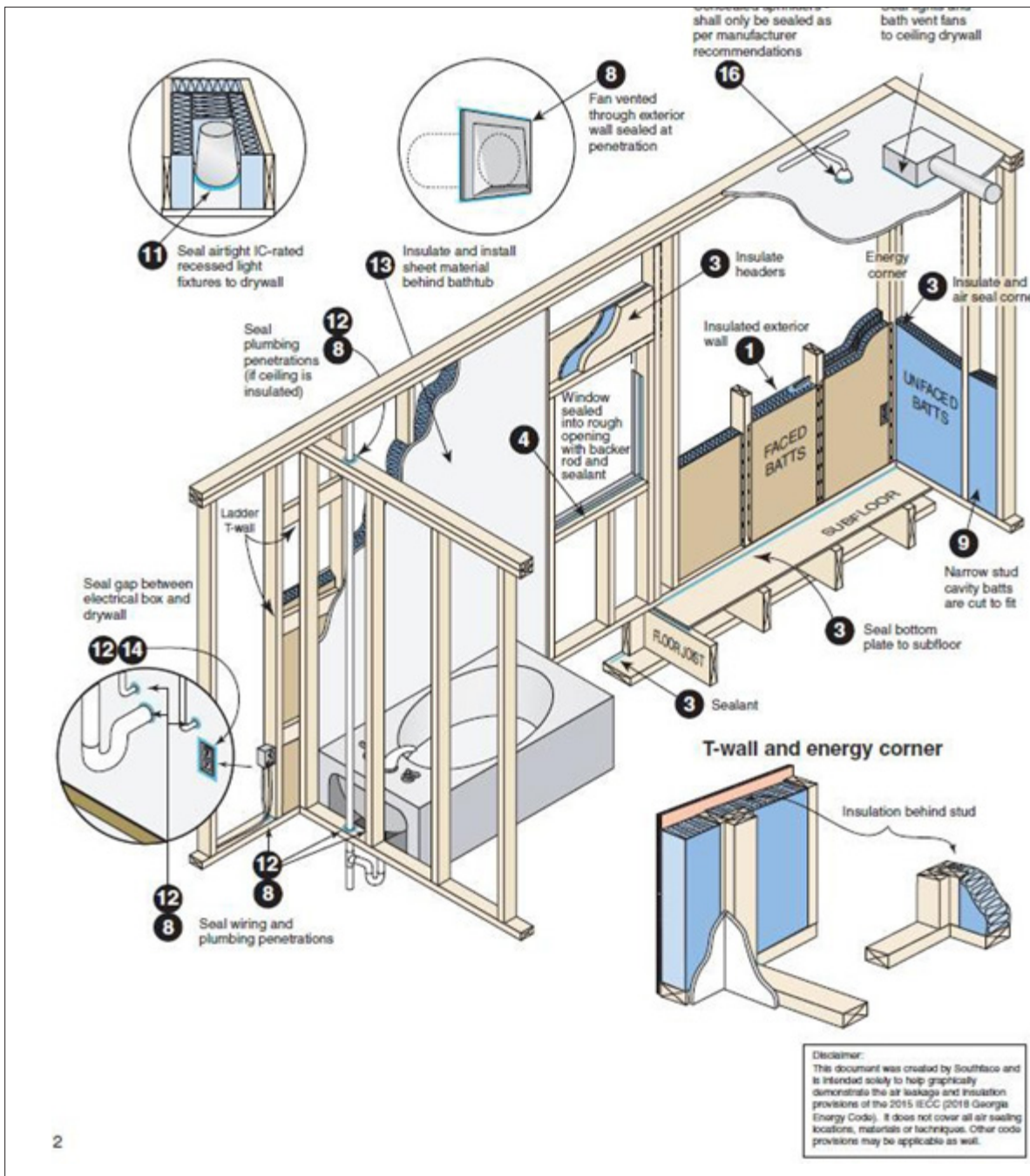

Disclaimer: This document is intended solely to help graphically demonstrate the air leakage provisions of section 402.4 of the 2012 IECC. It does not cover all air sealing locations or techniques. Other code provisions may be applicable as well.

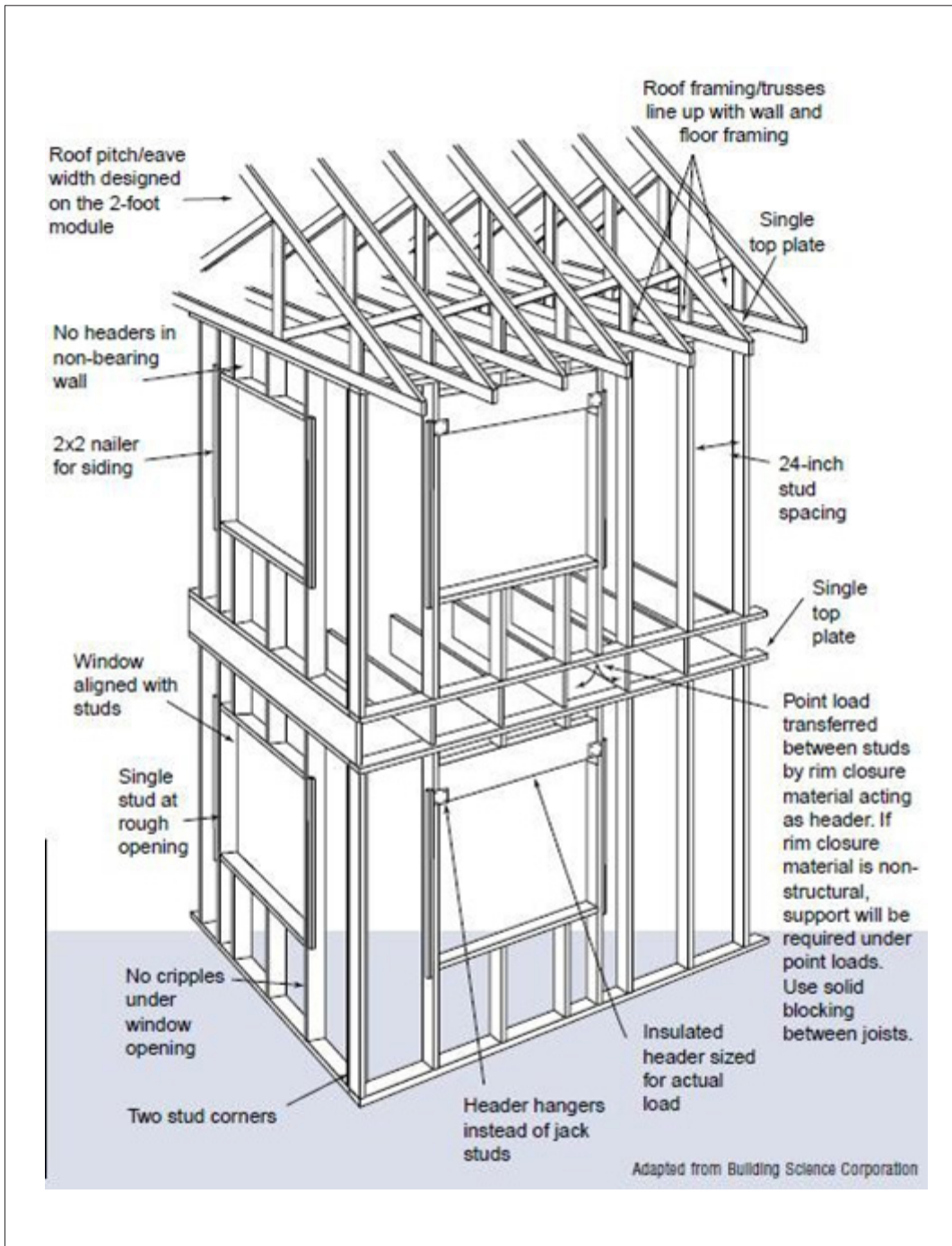

Advanced Framing

[www.nrel.gov/docs/fy01osti/26449.pdf](http://www.nrel.gov/docs/fy01osti/26449.pdf)

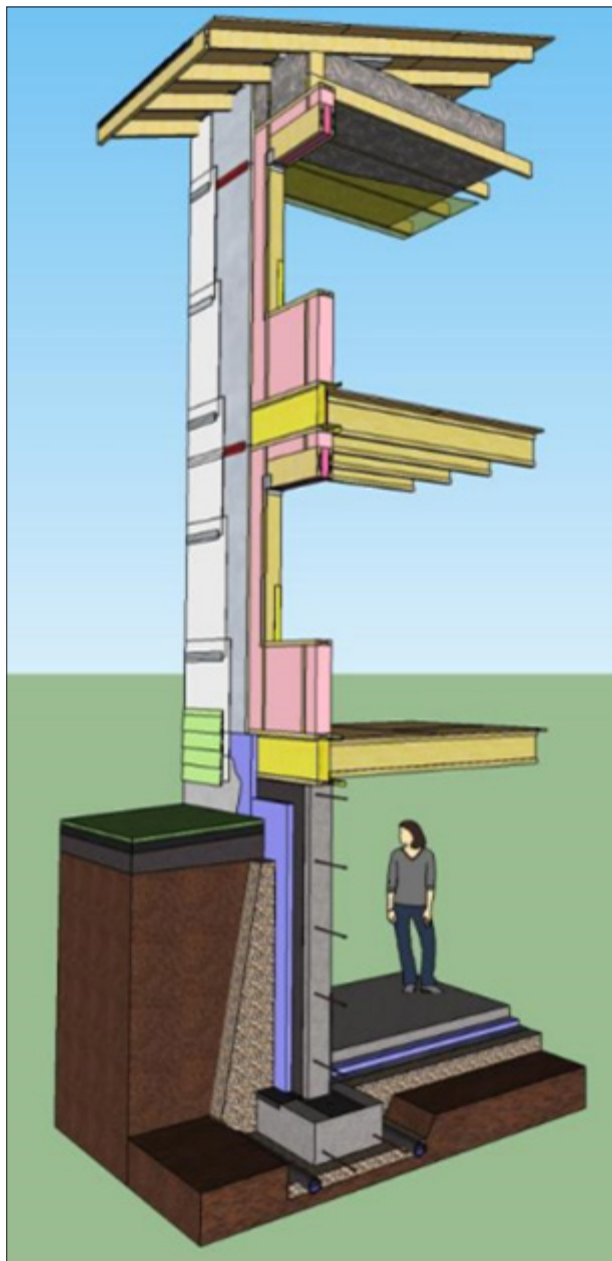
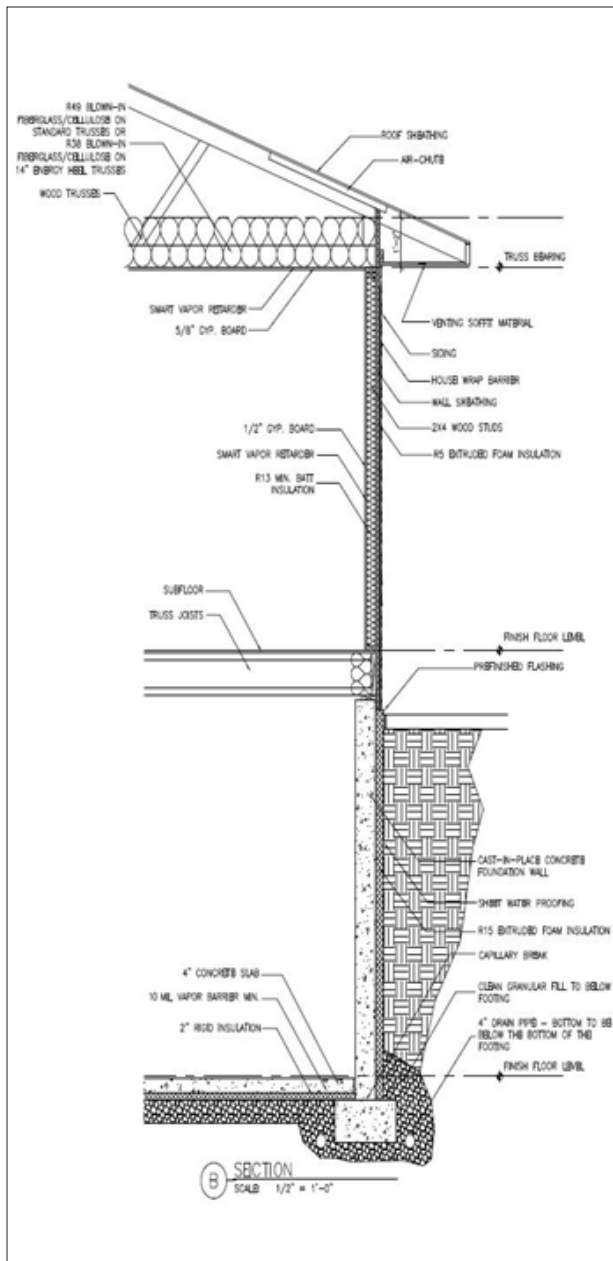

Model Wall Assembly (climate zone 5)

[www.buildingscience.com/documents/insights/bsi-001-the-perfect-wall?searchterm=wall%2520assembly](http://www.buildingscience.com/documents/insights/bsi-001-the-perfect-wall?searchterm=wall%2520assembly)

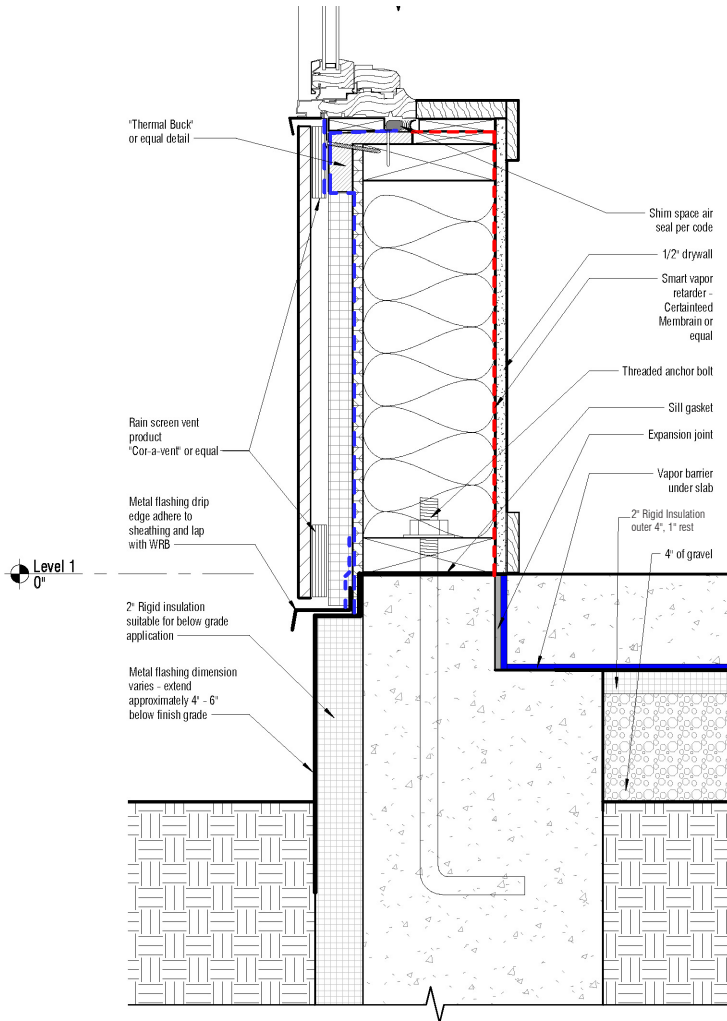

**1** Detail Section - Foundation and Sill  
3" = 1'-0" RE: 3/007

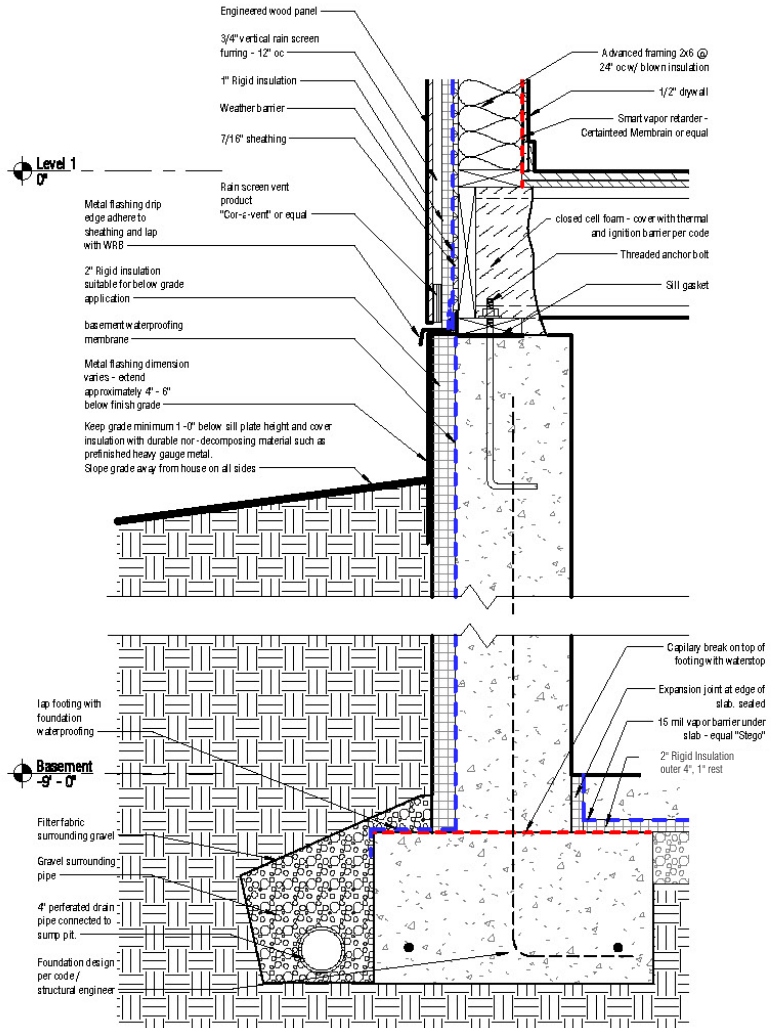

**4** Basement Wall Detail  
1 1/2" = 1'-0" RE: 6/008

**Preferred Slab Edge and Under Slab Insulation Detail**

Additional slab edge and under slab insulation resources:

Center for Sustainable Building Research and Oak Ridge National Laboratory - [foundationhandbook.ornl.gov/handbook/section2-2.shtml](http://foundationhandbook.ornl.gov/handbook/section2-2.shtml)

Building Science - [www.buildingscience.com/documents/building-science-insights-newsletters/bsi-118-concrete-solutions](http://www.buildingscience.com/documents/building-science-insights-newsletters/bsi-118-concrete-solutions)



Insulating Sheathing

[www.buildingscience.com/documents/guides-and-manuals/gm-guide-insulating-sheathing/view](http://www.buildingscience.com/documents/guides-and-manuals/gm-guide-insulating-sheathing/view)

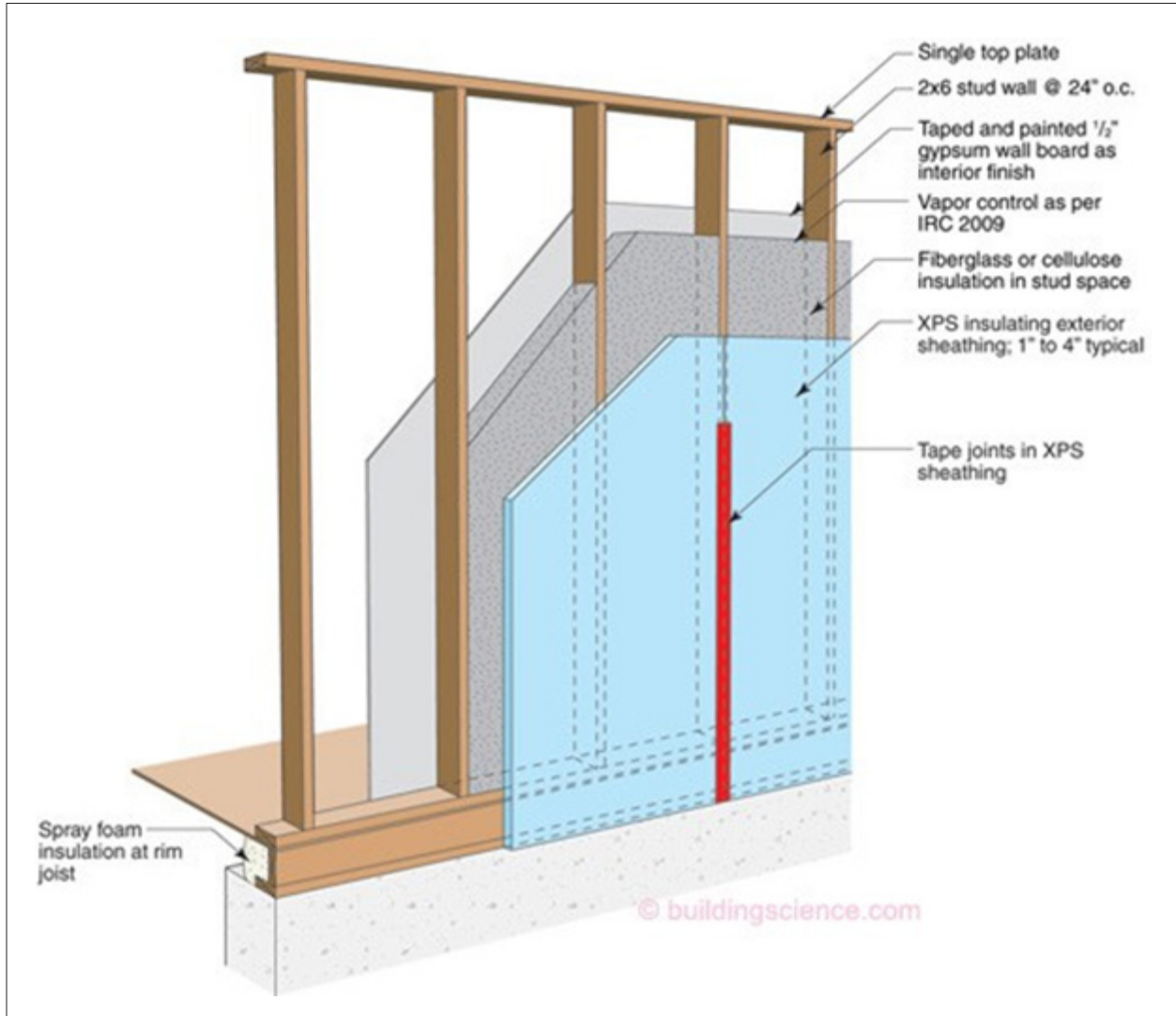

### High R-Value Wall

[www.buildingscience.com/documents/enclosures-that-work/high-r-value-wall-assemblies/copy\\_of\\_advanced-frame-wall-construction](http://www.buildingscience.com/documents/enclosures-that-work/high-r-value-wall-assemblies/copy_of_advanced-frame-wall-construction)



---

## RECOMMENDATIONS

- Project teams should engage a HERS rater as early in their project design stage as possible. Find a HERS rater here: [www.energystar.gov/partnerlocator](http://www.energystar.gov/partnerlocator). For additional information: [www.resnet.us/choose-the-right-contractor](http://www.resnet.us/choose-the-right-contractor)
- Review and follow the ENERGY STAR Certified New Homes partnership and training guidelines found at [www.energystar.gov/homes](http://www.energystar.gov/homes)
- During the design phase, work with the HERS rater to set energy-efficiency goals that comply with the energy performance requirements above.
- Contact your project's local energy supplier for available project energy design assistance and energy performance and equipment rebates.

## RESOURCES

- To identify a Home Energy Rater in your area: [www.energystar.gov/partnerlocator](http://www.energystar.gov/partnerlocator)
- Hire a project design team with documented experience in designing and overseeing construction of high performing buildings. The Iowa chapter of the American Institute of Architects maintains a searchable directory of architectural firms specializing in sustainable design as well as historic preservation. [www.aiaiowa.org/search/custom.asp?id=1701](http://www.aiaiowa.org/search/custom.asp?id=1701)
- Building Science Corporation provides a wealth of high performance building related resources, including a key word searchable database of research, publications, and best practices. [www.buildingscience.com/](http://www.buildingscience.com/)
- For more information regarding ENERGY STAR Certified New Homes: [www.energystar.gov/homes](http://www.energystar.gov/homes)





**PATH TO ZERO**

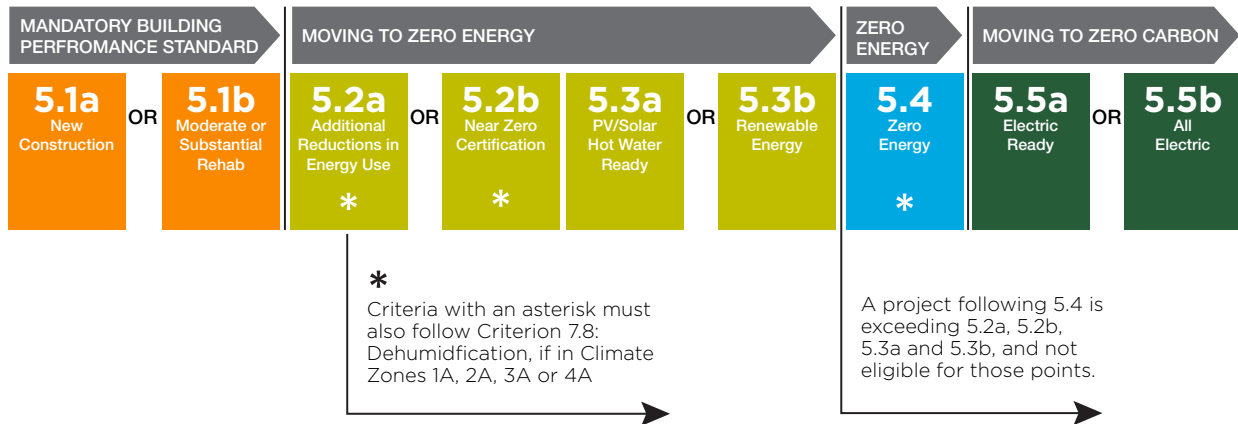

# 5.1a

## BASELINE FOR NEW CONSTRUCTION

# BUILDING PERFORMANCE STANDARD – SINGLE FAMILY AND MULTIFAMILY

### RATIONALE

Iowa Green Streets homes must meet strict program requirements and are independently verified to be energy-efficient and durable. These high-performance homes achieve energy savings in heating, cooling, hot water, lighting, and appliance efficiencies, which improve resident comfort, reduce operating costs and decrease greenhouse gas emissions. Reducing building emissions through energy efficiency strategies that are verified by a third party is the first step on the “path to zero.” Reporting projected operating energy and building emissions intensity frames the building’s performance in quantifiable, comparable, terms.

### REQUIREMENTS

A RESNET certified third-party (HERS) Rater must verify energy efficiency achievement meeting the performance levels identified in the Energy Performance Ratings, Air Barrier and Insulation Inspection Component Guide, and Energy Performance Table in Criterion 5.1 above.

Using the IEDA provided scope of work template, issue a request for proposals for a HERS Rater, or if applicable, use a HERS Rater provided by IEDA.

During the design phase, work with a qualified mechanical engineer/HVAC contractor knowledgeable of building science principles and RESNET certified Home Energy Rater (HERS Rater) to set energy efficiency goals that comply with the performance levels in Criterion 5.1. After the project team has decided on an “energy package,” incorporate the finalized building performance thresholds and measures into the project plans and specs and/or scope of work. Create and implement a verification plan during the construction processes and conduct building performance inspections, post-construction testing and final reporting.

The software used for the energy modeling during the design stage and to generate the HERS Index and certificate must be approved by RESNET. Any method or strategy, except for electric-generating renewable energy systems, can be implemented to satisfy the targeted minimum energy performance.

When submitting reimbursement claims to the Iowa Economic Development Authority, have the project construction manager, or their representative, email pictures to [greenstreets@iowaeda.com](mailto:greenstreets@iowaeda.com) showing, if applicable, installation of floor/slab insulation, capillary break on footing, advanced framing, exterior rigid insulation, air sealing, and duct sealing. Utilize best practices such as pictured in Criterion 5.1 and Air Sealing Key Points images in Appendix G to achieve building high performance.

## RECOMMENDATIONS

- Contact the local gas or electric utility provider to determine potential incentives and technical assistance. Depending on the size of project and utility provider, energy modeling assistance may be available.
- Because project teams must engage a qualified individual—a Rater—throughout construction to complete third-party inspections and certify to ENERGY STAR, it’s often useful to clearly identify their role in the project in relation to other project team members. Review the program guidance on partnership, training, qualifications, credentialing, and certification process online for your project’s appropriate version of ENERGY STAR Residential New Construction. Builders, Developers, Raters, ASHRAE Path Modelers, and Functional Testing Agents (FT Agents) have eligibility requirements. We recommend that project teams engage these partners as early in their project design stage as possible. Find a Rater here: [www.energystar.gov/partnerlocator](http://www.energystar.gov/partnerlocator). For additional information: [www.resnet.us/choose-the-right-contractor](http://www.resnet.us/choose-the-right-contractor).
- During the design phase, work with the Rater and/or ASHRAE Path Modeler to set energy-efficiency goals that comply with the appropriate ENERGY STAR Residential New Construction Program. After the project team has decided on a compliant energy package, build these measures into the project plans and specs, and work with the Rater, design team and contractor to create and implement a verification plan throughout construction.
- The ENERGY STAR Residential New Construction Programs allow Raters to use a Verification Oversight Organization (VOO)—approved sampling protocol to assess a group of dwelling units to meet ENERGY STAR guidelines based on pre-analysis of building plans, and subsequent testing and inspections of a sample set of the dwelling units. Where a sampling protocol does not sufficiently describe methodology for multifamily projects, use the RESNET Guidelines for Multifamily Energy Ratings, available at [resnet.us/blog/resnet-adopts-guidelines-for-multifamily-energy-ratings/](http://resnet.us/blog/resnet-adopts-guidelines-for-multifamily-energy-ratings/) for projects permitted before July 1, 2020.

---

## RESOURCES

- ENERGY STAR Residential New Construction Programs (MFNC, Manufactured, and Homes). [www.energystar.gov/newhomes/homes\\_prog\\_reqs/multifamily\\_national\\_page](http://www.energystar.gov/newhomes/homes_prog_reqs/multifamily_national_page)
- At the time of publishing, examples of modeling software that are approved for the ERI pathway are Ekotrope, EnergyGauge, and REM/Rate. Find the up-to-date list here: [www.resnet.us/providers/accredited-providers/hers-software-tools/](http://www.resnet.us/providers/accredited-providers/hers-software-tools/)
- Examples of modeling software that meet ASHRAE 90.1 Appendix G, Section G2.2 requirements include, but are not limited to DOE-2, eQUEST, TRACE, HAP, and EnergyGauge.
- ENERGY STAR. To identify a Rater in your area: [www.energystar.gov/partnerlocator](http://www.energystar.gov/partnerlocator)
- Residential Energy Services Network (RESNET). For more information on the sampling protocols, see Chapter 6, Technical Requirements for Sampling, Mortgage Industry National Home Energy Rating Systems: [www.resnet.us/about/standards/minhers/](http://www.resnet.us/about/standards/minhers/) and Guidelines for Multifamily Energy Ratings: [www.resnet.us/wp-content/uploads/Adopted\\_RESNET\\_Guidelines\\_for\\_Multifamily\\_Ratings\\_8-29-14.pdf](http://www.resnet.us/wp-content/uploads/Adopted_RESNET_Guidelines_for_Multifamily_Ratings_8-29-14.pdf)
- ENERGY STAR, Portfolio Manager Greenhouse Gas Emissions Technical Reference. Review the guidance here for quantifying project emissions. [portfoliomanager.energystar.gov/pdf/reference/Emissions.pdf](http://portfoliomanager.energystar.gov/pdf/reference/Emissions.pdf)

## 5.1b

### **BASELINE**

#### ***FOR MODERATE AND SUBSTANTIAL REHABS***

## **BUILDING PERFORMANCE STANDARD – SINGLE FAMILY AND MULTIFAMILY**

### **RATIONALE**

Dwelling units rehabilitated to a whole-building energy efficiency standard achieve energy savings in heating, cooling, hot water, lighting, and appliance efficiencies, which improve resident comfort, lower operating costs, and decrease greenhouse gas emissions.

Reducing building emissions through energy efficiency strategies that are verified by a third party is the first step on the “path to zero.” Reporting projected operating energy and building emissions intensity frames the building’s performance in quantifiable, comparable terms.

### **REQUIREMENTS**

A RESNET certified third-party (HERS) Rater must verify energy efficiency achievement meeting the performance levels identified in the Energy Performance Ratings, Air Barrier and Insulation Inspection Component Guide, and Energy Performance Table in Criterion 5.1 above.

Using the IEDA provided scope of work template, issue a request for proposals for a HERS Rater, or if applicable, use a HERS Rater provided by IEDA.

During the design phase, work with a qualified mechanical engineer/HVAC contractor knowledgeable of building science principles and RESNET certified Home Energy Rater (HERS Rater) to set energy efficiency goals that comply with the performance levels in Criterion 5.1. After the project team has decided on an “energy package,” incorporate the finalized building performance thresholds and measures into the project plans and specs and/or scope of work. Create and implement a verification plan during the construction processes and conduct building performance inspections, post-construction testing and final reporting.

The software used for the energy modeling during the design stage and to generate the HERS Index and certificate must be approved by RESNET. Any method or strategy, except for electric-generating renewable energy systems, can be implemented to satisfy the targeted minimum energy performance.

When submitting reimbursement claims to the Iowa Economic Development Authority, have the project construction manager, or their representative, email pictures to [greenstreets@iowaeda.com](mailto:greenstreets@iowaeda.com) showing, if applicable, installation of floor/slab insulation, capillary break on footing, advanced framing, exterior rigid insulation, air sealing, and duct sealing. Utilize best practices such as pictured in Criterion 5.1 and Air Sealing Key Points images in Appendix G to achieve building high performance.

**AND**

- Compartmentalization of dwelling units via air infiltration no greater than 0.30 CFM50 for Substantial Rehab and not greater than 0.40 CFM50 for Moderate Rehab per square feet of dwelling unit enclosure area, following procedures in current version of ANSI/RESNET/ICC Std. 380. Sampling allowed per Criterion 5.1.
- Any insulation installed as part of the rehab achieves Grade I installation per ANSI/RESNET/ICC Std. 301. Or, Grade II cavity insulation is permitted to be used for assemblies that contain a layer of continuous, air impermeable insulation  $\geq$  R-5. And, Grade II batts are permitted to be used in floors if they fill the full width and depth of the floor cavity, even when compression occurs due to excess insulation, as long as the R-value of the batts has been appropriately assessed based on manufacturer guidance and the only defect preventing the insulation from achieving Grade I is the compression caused by the excess insulation.
- For HVAC systems repaired or installed during rehab, complete testing via the current version of the National HVAC Functional Testing Checklist, ENERGY STAR Multifamily New Construction Version at time of plan review.

**RECOMMENDATIONS**

- See Resources listed in Criterion 5.1a.

**RESOURCES**

- To identify a Rater in your area: [www.energystar.gov/partnerlocator](http://www.energystar.gov/partnerlocator). For additional information: [www.resnet.us/choose-the-right-contractor](http://www.resnet.us/choose-the-right-contractor)
- For a list of software approved by RESNET (EPA-approved VOO) to generate an ERI compliant HERS Index score: [www.resnet.us/professional/programs/energy\\_rating\\_software](http://www.resnet.us/professional/programs/energy_rating_software)
- Building America Solution Center – Air Sealing: [basc.pnnl.gov/checklist-focus/air-sealing](http://basc.pnnl.gov/checklist-focus/air-sealing)
- Examples of modeling software that meet ASHRAE 90.1 Appendix G, Section G2.2 requirements include, but are not limited to: DOE-2, eQUEST, TRACE, HAP, and EnergyGauge.
- Building Performance Institute, Inc. (BPI). Develops standards for energy-efficiency retrofit work, certifies professional workers, and accredits BPI GoldStar Contractors. [www.bpi.org/](http://www.bpi.org/)
- Residential Energy Services Network (RESNET). A resource where residents can learn about the energy audit and rating process. [www.resnet.us](http://www.resnet.us)
- Enterprise Green Communities Single-Family and Multifamily Rehabilitation Specifications. A set of green specifications—one for single family and one for multifamily— written in MasterSpec that include insulation, air sealing, and other details that can be customized to your project. [www.enterprisecommunity.org/solutions-and-innovation/green-communities/tools-and-services/construction-specifications](http://www.enterprisecommunity.org/solutions-and-innovation/green-communities/tools-and-services/construction-specifications)
- U.S. Department of Energy, Air Sealing, Technology Fact Sheet. This fact sheet describes the importance of sealing air leaks and providing controlled ventilation. [www1.eere.energy.gov/buildings/publications/pdfs/building\\_america/26446.pdf](http://www1.eere.energy.gov/buildings/publications/pdfs/building_america/26446.pdf)
- U.S. Department of Energy, Retrofit Techniques, & Technologies: Air Sealing [www.energy.gov/sites/prod/files/2013/11/f5/ba\\_airsealing\\_report.pdf](http://www.energy.gov/sites/prod/files/2013/11/f5/ba_airsealing_report.pdf)
- 2018 IECC Climate Zones Map. A detailed map that shows Climate Zones zoomed into each state and county as well as the basic 2018 IECC Building Code requirements for each Climate Zone. [codes.iccsafe.org/content/iecc2018/chapter-3-ce-general-requirements](http://codes.iccsafe.org/content/iecc2018/chapter-3-ce-general-requirements)
- For more information on ASHRAE 90.1-2013 and ASHRAE 90.1-2016. [www.ashrae.org](http://www.ashrae.org)
- ENERGY STAR Portfolio Manager, Greenhouse Gas Emissions Technical Reference. Review the guidance here for quantifying project emissions. [portfoliomanager.energystar.gov/pdf/reference/Emissions.pdf](http://portfoliomanager.energystar.gov/pdf/reference/Emissions.pdf)

## 5.1c

### BASELINE

#### FOR NEW CONSTRUCTION

## BUILDING PERFORMANCE REQUIREMENTS – COMMERCIAL, NONPROFIT, MIXED-USE

### RATIONALE

Other than the staffing inside them, for many commercial, public, and nonprofit organizations, one of their greatest expenses is the operation and maintenance of buildings. Buildings designed and constructed in an integrated fashion with clearly defined goals and performance expectations can achieve substantial energy savings in heating, cooling, hot water, lighting, and appliance efficiencies, while improving occupant comfort, lowering operating costs, and decreasing greenhouse gas emissions.

Reducing building emissions through energy efficiency strategies that are verified by a third party is the first step on the “path to zero.”

### REQUIREMENTS

- Follow all applicable requirements and best practices in the Energy Performance Ratings, Air Barrier and Insulation Inspection Component Guide, and Energy Performance Table in Criterion 5.1 above.
- Projects must exceed the performance of the current state of Iowa adopted Energy Code at the time of submittal for plan review by at least 10 percent.
- Commission the building and its systems following one of the commissioning processes identified in the resources section below. In addition, include envelope commissioning in the commissioning agent's scope of work.
- For insulation values, all project types shall meet or exceed the values in Criterion 5.1, including the continuous exterior foam insulation to achieve a thermal break.
- Pass a slab insulation and pre-drywall thermal bypass inspection by a third-party energy rater trained and certified by RESNET or Building Performance Institute to verify proper sealing and insulation practices per the Energy Performance Table in Criterion 5.1 or include this scope in the commissioning agent's scope noted in this section.
- Using the applicable IECC or ASHRAE 90.1 standard, submit completed to the Iowa Economic Development Authority, energy modeling information showing adherence to exceeding the current state of Iowa adopted Energy Code by 10 percent, code certificate and thermal bypass checklist.
- When submitting reimbursement claims to the Iowa Economic Development Authority, have the project construction manager, or their representative, email pictures to [greenstreets@iowaeda.com](mailto:greenstreets@iowaeda.com) showing installation of floor/slab insulation, capillary break on footing, advanced framing, exterior rigid insulation, air sealing, and duct sealing. Utilize best practices such as pictured in Criterion 5.1 to achieve building high performance. Include commissioning agent's reports with applicable reimbursement claims.

## RECOMMENDATIONS

- Utilize the integrated design approach and resources provided in section 1 of the Iowa Green Streets Criteria and appendices including the use of a project priorities survey, an integrated design process, incorporating specific references to the Iowa Green Streets Criteria in construction documents and specifications, and implementing a construction management and contractor/subcontractor education plan.
- Contact the local gas or electric utility provider to determine potential incentives and technical assistance. Depending on the size of project and utility provider, energy modeling assistance may be available.

## RESOURCES

- Use the commissioning process from one or more of these resources to complete the required commissioning:
  - ASHRAE Guideline 0-2013 The Commissioning Process and/or ASHRAE Guidelines 1.1-2007 and 1.5-2012:  
[www.techstreet.com/ashrae/standards/guideline-0-2013-the-commissioning-process?product\\_id=1870180](http://www.techstreet.com/ashrae/standards/guideline-0-2013-the-commissioning-process?product_id=1870180)
  - ASHRAE Standard 202-2013 The Commissioning Process for Buildings and Systems—the industry accepted Commissioning Standard:  
[www.techstreet.com/ashrae/standards/ashrae-202-2013?product\\_id=1862482](http://www.techstreet.com/ashrae/standards/ashrae-202-2013?product_id=1862482)
  - Whole Building Design Guide Building Commissioning: [www.wbdg.org/building-commissioning](http://www.wbdg.org/building-commissioning)
  - Leadership in Energy and Environmental Design (LEED) Fundamental Commissioning of the Building Energy Systems, [www.usgbc.org/credits/new-construction/v22/eap1?view=language](http://www.usgbc.org/credits/new-construction/v22/eap1?view=language), in accordance with LEED for New Construction 2.2 Reference Guide
- Advanced Building Core Performance Guide is a “direct, simplified approach to achieve predictable energy savings in small- to medium-sized buildings without the need for modeling”:  
[www.advancedbuildings.net/core-performance](http://www.advancedbuildings.net/core-performance)
- Building Science Corporation provides a wealth of information on Optimum Value Engineering (Advanced Framing) to reduce framing material costs and improve wall performance:  
[www.buildingscience.com/documents/enclosures-that-work/high-r-value-wall-assemblies/copy\\_of\\_advanced-frame-wall-construction](http://www.buildingscience.com/documents/enclosures-that-work/high-r-value-wall-assemblies/copy_of_advanced-frame-wall-construction)
- APA – The Engineered Wood Association provides for free the “Advanced Framing Construction Guide”: [www.apawood.org/advanced-framing](http://www.apawood.org/advanced-framing)
- Residential Energy Services Network (RESNET) certifies and provides guidance and oversees quality assurance in home rating services: [www.resnet.us](http://www.resnet.us)
- See Resources for Criterion 5.1 and 5.1a

## 5.1d

### **BASELINE**

#### ***FOR SUBSTANTIAL AND MODERATE REHABS***

## **BUILDING PERFORMANCE REQUIREMENTS – COMMERCIAL, NONPROFIT, MIXED-USE**

### **RATIONALE**

Other than the staffing inside them, for many commercial, public and nonprofit organizations, one of their greatest expenses is the operation and maintenance of buildings. Building rehabilitation projects where design and construction take place in an integrated fashion with clearly defined goals and performance expectations can achieve substantial energy savings in heating, cooling, hot water, lighting, and appliance efficiencies, while improve occupant comfort, lower operating costs, and decrease greenhouse gas emissions.

Reducing building emissions through energy efficiency strategies that are verified by a third party is the first step on the “path to zero.”

### **REQUIREMENTS**

- Follow all applicable requirements and best practices in the Energy Performance Ratings, Air Barrier and Insulation Inspection Component Guide, and Energy Performance Table in Criterion 5.1 above.
- Substantial building rehabilitation projects must exceed the performance of the current state of Iowa adopted Energy Code at the time of submittal for plan review by at least 10 percent.
- Moderate building rehabilitation projects must meet or exceed the performance of the current state of Iowa adopted Energy Code at the time of submittal for plan review.
- Commission the building and its systems following one of the commissioning processes identified in the resources section below. In addition, include envelope commissioning in the commissioning agent's scope of work.
- For insulation values, all project types shall meet or exceed the values in Criterion 5.1, including the continuous exterior foam insulation to achieve a thermal break.
- Pass a slab insulation and pre-drywall thermal bypass inspection by a third-party energy rater trained and certified by RESNET or Building Performance Institute to verify proper sealing and insulation practices per the Energy Performance Table in Criterion 5.1 or include in the commissioning scope of work noted in this section.
- Submit to IEDA modeling information verifying exceeding by 10% the current version of ASHRAE 90.1 as coordinated with the adopted edition of the IECC for the State of Iowa, code certificate, and thermal bypass checklist/commissioning report.
- When submitting reimbursement claims to the Iowa Economic Development Authority, have the project construction manager, or their representative, email pictures to [greenstreets@iowaeda.com](mailto:greenstreets@iowaeda.com) showing installation of floor/slab insulation, capillary break on footing, advanced framing, exterior rigid insulation, air sealing, and duct sealing. Utilize best practices such as pictured in Criterion 5.1 to achieve building high performance. Include commissioning agent's reports with applicable reimbursement claims.



## RECOMMENDATIONS

- Utilize the integrated design approach and resources provided in section 1 of the Iowa Green Streets Criteria and appendices including the use of a project priorities survey, an integrated design process, incorporating specific references to the Iowa Green Streets Criteria in construction documents and specifications, and implementing a construction management and contractor/subcontractor education plan.
- Contact the local gas or electric utility provider to determine potential incentives and technical assistance. Depending on the size of project and utility provider, energy modeling assistance may be available.

## RESOURCES

- Use the commissioning process from one or more of these resources to complete the required commissioning:
  - ASHRAE Guideline 0-2013 The Commissioning Process and/or ASHRAE Guidelines 1.1-2007 and 1.5-2012:  
[www.techstreet.com/ashrae/standards/guideline-0-2013-the-commissioning-process?product\\_id=1870180](http://www.techstreet.com/ashrae/standards/guideline-0-2013-the-commissioning-process?product_id=1870180)
  - ASHRAE Standard 202-2013 The Commissioning Process for Buildings and Systems—the industry accepted Commissioning Standard:  
[www.techstreet.com/ashrae/standards/ashrae-202-2013?product\\_id=1862482](http://www.techstreet.com/ashrae/standards/ashrae-202-2013?product_id=1862482)
  - Whole Building Design Guide Building Commissioning: [www.wbdg.org/building-commissioning](http://www.wbdg.org/building-commissioning)
  - Leadership in Energy and Environmental Design (LEED) Fundamental Commissioning of the Building Energy Systems, [www.usgbc.org/credits/new-construction/v22/eap1?view=language](http://www.usgbc.org/credits/new-construction/v22/eap1?view=language), in accordance with LEED for New Construction 2.2 Reference Guide
- Advanced Building Core Performance Guide is a “direct, simplified approach to achieve predictable energy savings in small- to medium-sized buildings without the need for modeling”:  
[www.advancedbuildings.net/core-performance](http://www.advancedbuildings.net/core-performance)
- Building Science Corporation provides a wealth of information on Optimum Value Engineering (Advanced Framing) to reduce framing material costs and improve wall performance:  
[www.buildingscience.com/documents/enclosures-that-work/high-r-value-wall-assemblies/copy\\_of\\_advanced-frame-wall-construction](http://www.buildingscience.com/documents/enclosures-that-work/high-r-value-wall-assemblies/copy_of_advanced-frame-wall-construction)
- APA – The Engineered Wood Association provides for free the “Advanced Framing Construction Guide”: [www.apawood.org/advanced-framing](http://www.apawood.org/advanced-framing)
- Residential Energy Services Network (RESNET) certifies and provides guidance and oversees quality assurance in home rating services: [www.resnet.us](http://www.resnet.us)
- See Resources for Criterion 5.1 and 5.1a

## 5.2a

### OPTIONAL 5 TO 12 POINTS

#### BASELINE

*FOR DISASTER RECOVERY HOUSING PROJECTS TO ACHIEVE  $\geq$  5 POINTS*

## MOVING TO ZERO ENERGY: ADDITIONAL REDUCTIONS IN ENERGY USE

### ELIGIBILITY

- Projects following a prescriptive path of Criterion 5.1a are not eligible for points from this criterion, as they are not able to demonstrate compliance.
- Projects acquiring points from Criterion 5.2b or Criterion 5.4 are not eligible for points from this criterion, as they exceed this level of performance.

### RATIONALE

Improvements in building energy performance result in utility cost savings from more efficient heating, cooling, hot water, lights, and appliances, which improve residents' comfort, lower operating costs, and decrease greenhouse gas emissions. From a resilience standpoint, a highly energy-conserving building envelope will help to ensure that habitable temperatures will be maintained in the event of extended loss of power or interruptions in heating fuel (passive survivability).

Reducing building emissions through energy efficiency strategies that are verified by a third party and go beyond the level of energy efficiency that is required of the property places a property further along the “path to zero.”

### REQUIREMENTS

Design and construct a building that is projected to be more efficient than what is required of the project in Criterion 5.1a-5.1d. These additional reductions in energy use must be captured by energy conservation measures associated with improved building component systems (HERS and ASHRAE) and not through the addition of on-site power generation:

- If utilizing a HERS Index for 5.1a or 5.1b compliance:
  - HERS score at least five points lower than required [5 points]
  - AND
  - each additional two-point decrease in HERS score [1 point]
- If following ASHRAE path for 5.1a-5.1d compliance:
  - 5% greater efficiency than required [5 points]
  - AND
  - each additional 1% greater efficiency [1 point]



---

## RESOURCES

DOE's **Building America Solution Center** provides access to expert information on hundreds of high-performance construction topics, including research publications, tools, specs, details, webinars, and newsletters on cost-effective, energy-efficient building strategies. [basc.pnnl.gov/](http://basc.pnnl.gov/)

## 5.2b

### OPTIONAL 15 POINTS MAXIMUM

#### Baseline 5.2b OR 5.4 FOR IOWA GREEN STREETS CERTIFICATION PLUS

## MOVING TO ZERO ENERGY: NEAR ZERO CERTIFICATION

### ELIGIBILITY

- Projects acquiring points through this criterion are not eligible for points from Criterion 5.2a or Criterion 5.4.
- At the time of project completion, proof of certification to IEDA for the program selected through Criterion 5.2b will suffice for compliance with both Criteria 5.1a and 5.1b and Criterion 5.2b. If the project is unable to demonstrate compliance with Criterion 5.2b at post construction, the project will not be eligible for those optional points and the project must demonstrate compliance with Criteria 5.1a or 5.1b in order to be eligible for certification.

### RATIONALE

These complementary whole building certification programs emphasize strategies that aggressively reduce whole building energy loads, reducing the need to heat and cool, reducing utility bills, reducing associated greenhouse gas emissions, and increasing project capacity to sustain habitability during loss of power.

Reducing building emissions through energy efficiency strategies that are as aggressive as possible and verified by a third party comes close to eliminating building emissions associated with the amount of energy a building requires to operate, moving further along the “path to zero.”

### REQUIREMENTS

Certify the project in a program that requires advanced levels of building envelope performance, such as DOE Zero Energy Ready Home (ZERH) and/or Passive House Institute (PHI) Classic or Passive House Institute U.S. (version of PHIUS relevant to the project’s construction type and permit date).

- DOE ZERH certification [12 points]
- PHI Classic or PHIUS certification (version relevant to the project’s construction type and permit date) [15 points]

### RECOMMENDATIONS

Each of these programs requires a significant commitment to ensure significant levels of project performance. Begin strategizing how to achieve your project goals through dual certification with these programs as early in the integrative design process as possible.

---

## RESOURCES

- PHIUS. Committed to making high-performance passive building the mainstream market standard. A Passive House is a set of design principles and a quantifiable performance standard applied to any building project, producing radically less energy needs, unparalleled comfort, and supreme air quality. [www.phius.org/home-page](http://www.phius.org/home-page) and [www.phaus.org](http://www.phaus.org)
- PHI. An international standard for buildings with minimum energy consumption. [passivehouse.com/](http://passivehouse.com/)
- Department of Energy, ZERH. This program builds upon ENERGY STAR for Homes, along with proven Building America innovations and best practices. These homes are third-party verified. [energy.gov/eere/buildings/guidelines-participating-doe-zero-energy-ready-home](http://energy.gov/eere/buildings/guidelines-participating-doe-zero-energy-ready-home). See these case studies from affordable housing. [www.energy.gov/eere/buildings/downloads/zerh-webinar-voice-builder-affordable](http://www.energy.gov/eere/buildings/downloads/zerh-webinar-voice-builder-affordable)

## 5.3a

### OPTIONAL 3 POINTS

#### BASELINE

#### FOR DISASTER RECOVERY HOUSING PROJECTS

## MOVING TO ZERO ENERGY: PHOTOVOLTAIC/SOLAR HOT WATER READY

### ELIGIBILITY

- Projects that meet DOE ZERH (5.2b) and complete the photovoltaic (PV) Ready Checklist under that program automatically comply with Option 1 of this criterion and are not eligible for points.
- Projects acquiring points through this criterion are not eligible for points from Criterion 5.3b or Criterion 5.4.

### RATIONALE

Designing for the future installation of PV or solar hot water systems allows a building owner the flexibility to transition to increased energy generation through renewable energy sources as resources become cost competitive. Installation of renewable energy systems is a hedge against rising costs for purchased energy and for cleaner energy sources.

Rather than focusing on reducing building emissions associated with how much energy the building requires to operate, this criterion is a preparatory step for reducing emissions associated with the source of energy for the property, a key consideration along the “path to zero.”

### REQUIREMENTS

Orient, design, engineer, wire, and/or plumb the development through one of the following options to accommodate installation of a PV or solar hot water system in the future.

#### ***Option 1: PV Ready***

Submit a complete Department of Energy ZERH PV Ready Checklist. Iowa projects are exempt from having to meet the average daily solar radiation requirement on the checklist.

#### ***Option 2: Solar Hot Water Ready***

Submit a complete Department of Energy ZERH Solar Hot Water Ready Checklist.

### RECOMMENDATIONS

Determine if the placement of the solar equipment impacts the roof warranty.



---

## RESOURCES

- Department of Energy, ZERH PV Ready Checklist.  
[www.energy.gov/sites/prod/files/2015/05/f22/PV-Ready%20Checklist.pdf](http://www.energy.gov/sites/prod/files/2015/05/f22/PV-Ready%20Checklist.pdf)
- Department of Energy, ZERH Solar Hot Water Ready Checklist.  
[www.energy.gov/sites/prod/files/2015/05/f22/SHW-Ready%20Checklists\\_0.pdf](http://www.energy.gov/sites/prod/files/2015/05/f22/SHW-Ready%20Checklists_0.pdf)
- National Renewable Energy Laboratory (NREL), “Solar Ready Buildings Planning Guide,” Technical Report (NREL/TP-7A2-46078). A paper published by NREL in December 2009 that details design guidelines and checklists for designing solar-ready buildings.  
[www.nrel.gov/docs/fy10osti/46078.pdf](http://www.nrel.gov/docs/fy10osti/46078.pdf)

## 5.3b

### OPTIONAL 8 POINTS MAXIMUM

## MOVING TO ZERO ENERGY: RENEWABLE ENERGY

### ELIGIBILITY

Projects acquiring points through this criterion are not eligible for points from Criterion 5.3a or 5.4.

### RATIONALE

Renewable energy reduces environmental impacts such as greenhouse gas emissions that are associated with energy sourced and produced from fossil fuels. Use of renewable energy technologies can also result in energy cost savings.

Rather than focusing on reducing building emissions associated with how much energy the building requires to operate, this criterion reduces building emissions associated with the source of energy for the property, a key strategy along the “path to zero.”

### REQUIREMENTS

PV panels or other electric-generating renewable energy source to provide a specified percentage of the project’s estimated source energy demand. The renewable energy may be owned and produced on-site or off-site if the associated renewable energy certificates (RECs) are retained or retired by the building owner. Or, the renewable energy may be procured through a contract of at least 20 years from community solar, virtual power purchase agreements or Green-E certified renewable energy certificates.

When calculating points for Criterion 5.3b, evaluate the percentage of either your project’s total energy demand that is satisfied by a renewable energy source or the percentage of your project’s common load energy demand that is satisfied by a renewable energy source. Refer to the table below for the point structure.

#### Option 1

#### PERCENTAGE OF TOTAL PROJECT ENERGY CONSUMPTION PROVIDED BY RENEWABLE ENERGY

	10%	25%	40%	55%	70%
Single-story/single-family	—	—	4 points	6 points	8 points
2–3 stories	—	4 points	6 points	8 points	—
4 stories or more multifamily	4 points	6 points	8 points	—	—
Commercial, Nonprofit, Mixed-Use	4 points	6 points	8 points	—	—

OR



## Option 2

### PERCENTAGE OF COMMON AREA METER ENERGY CONSUMPTION PROVIDED BY RENEWABLE ENERGY

	60%	70%	80%	90%	100%
Any multifamily project	1 point	2 points	3 points	4 points	5 points
Commercial, Nonprofit, Mixed-Use	1 point	2 points	3 points	4 points	5 points

## RECOMMENDATIONS

- To provide a higher percentage of the project's estimated annual energy consumption with electric-generating renewable energy sources, focus on reducing the building's overall energy consumption in Criteria 5.1 and 5.2 with energy-efficiency measures, which are generally more cost-effective and longer lasting than renewables.
- Early on, consider how to establish an active asset management and/or operations plan for monitoring the solar systems. Otherwise, it is all too common to not be able to tell when these systems are not working.
- Consider installing solar water heating systems for stand-alone laundry facilities in multifamily and commercial projects.
- Evaluate and review your maintenance contract to ensure that it includes all renewable systems and appropriate reviews and protocols for their maintenance, as well as the associated implications of roof-mounted systems.
- Refer to DOE's "A Common Definition for Zero Energy Buildings" for guidance on accounting for energy produced and consumed, but note the allowances in this criterion's requirement for certain additional permissible means of procurement.

## RESOURCES

- Department of Energy, A Common Definition for Zero Energy Buildings. Defines Zero Energy Buildings and includes guidance on on-site renewable energy production parameters. [www.energy.gov/sites/prod/files/2015/09/f26/bto\\_common\\_definition\\_zero\\_energy\\_buildings\\_093015.pdf](http://www.energy.gov/sites/prod/files/2015/09/f26/bto_common_definition_zero_energy_buildings_093015.pdf)
- American Solar Energy Society (ASES). A nonprofit organization committed to a sustainable energy economy, ASES accelerates the development and use of solar and other renewable energy resources through advocacy, education, research and collaboration among professionals, policymakers and the public. [www.ases.org](http://www.ases.org)
- Florida Solar Energy Center (FSEC). This is a resource for basic information on types of photovoltaic solar electric systems, sizing, installation, and system ratings. FSEC also has an industry resources page that includes its Photovoltaic System Design Course Manual, available at [www.fsec.ucf.edu/en/education/cont\\_ed/manuals/index.htm](http://www.fsec.ucf.edu/en/education/cont_ed/manuals/index.htm)
- National Renewable Energy Laboratory (NREL). Photovoltaic research at NREL provides a clearinghouse on all aspects of photovoltaic solar cell systems. [www.nrel.gov/](http://www.nrel.gov/)
- U.S. Department of Energy, Office of Energy Efficiency and Renewable Energy. This website provides information on renewable energy technologies and energy efficiency. [www.eere.energy.gov](http://www.eere.energy.gov)
- Database of State Incentives for Renewables & Efficiency (DSIRE) is the most comprehensive source of information on incentives and policies that support renewables and energy efficiency in the United States. Operated by the North Carolina Clean Energy Technology Center at North Carolina State University, with support from the Interstate Renewable Energy Council, Inc., DSIRE is funded by the U.S. Department of Energy. [www.dsireusa.org](http://www.dsireusa.org)

# 5.4

## OPTIONAL

**24 POINTS**

## BASELINE

**5.2B OR 5.4 FOR IOWA GREEN STREETS CERTIFICATION PLUS**

## ACHIEVING ZERO ENERGY

### ELIGIBILITY

- Projects acquiring points from this criterion are not eligible for points from Criteria 5.2a, 5.2b, 5.3a, or 5.3b.
- At the time of project completion submission, proof of certification to IEDA for the program selected through Criterion 5.4 will suffice for compliance with both Criteria 5.1a and 5.1b and the building certification component of Criterion 5.4. If the project is unable to demonstrate compliance with Criterion 5.4 at post construction, the project will not be eligible for those optional points and the project must demonstrate compliance with Criteria 5.1a or 5.1b in order to be eligible for Iowa Green Streets Criteria certification.

### RATIONALE

There are three essential strategies on the “path to zero,” the path toward reducing emissions associated with a building: reducing a building’s operating energy through energy efficiency practices, reducing a building’s emissions through the type of energy source that fuels that operating energy, and reducing a building’s emissions embodied in the materials that are used to construct the property. Criteria 5.1 and 5.2 address reducing operating energy needs, and Criteria 5.3 and 5.5 address reducing emissions through the property’s power sources. This criterion, 5.4, combines the two concepts, directing projects toward Zero Energy of operations.

Aggressive levels of energy efficiency coupled with renewable energy production, and/or purchase of renewable energy certificates, at levels equal to or greater than a project’s annual energy needs results in a Zero Energy Building or Renewable Energy Certificate Zero Energy Building (see “A Common Definition for Zero Energy Buildings,” in Resources). This strategy reduces nonrenewable energy usage, utility bills and greenhouse gas emissions.

### REQUIREMENTS

Achieve Zero Energy performance for the project through one of the following options.

#### **Option 1**

Certify each building in the project to DOE ZERH program (refer to Criterion 5.2b).

AND

Either install renewables and/or procure renewable energy, which in sum will produce as much, or more, energy in a given year than the project is modeled to consume. The renewable energy may be owned and produced on-site or off-site if the associated RECs are retained or retired by the building owner. Or, the renewable energy may be procured through a contract of at least 20 years from community solar, virtual power purchase agreements or Green-E certified renewable energy certificates.

## Option 2

Certify each building in the project in a program that requires Zero Energy performance such as PHIUS+ Source Zero, PHI Plus, PHI Premium, International Living Future Institute's Zero Energy Petal, Zero Carbon Petal, or Living Building Certification.

## RECOMMENDATIONS

- Consider coupling this criterion with Criterion 5.5a or 5.5b to move toward not only off-setting, but removing, combustion fuels from the property and further reducing associated emissions with the building's operations.
- Consider coupling this criterion with Criterion 6.5 and fully consider the implications of a zero emissions building from both the operations and the materials perspective—fully embracing the “path to zero.”
- Each of this criterion's options requires a significant commitment to ensure significant levels of project performance. Begin strategizing how to achieve your project goals through dual certification with these programs as early in the integrative design process as possible.
- Refer to DOE's A Common Definition for Zero Energy Buildings for guidance on accounting for energy produced and consumed, but note the allowances in this criterion's requirement for certain additional permissible means of procurement.
- Multifamily buildings and/or properties in urban locations may not have enough space for installation of enough on-site renewables to offset the property's energy consumption. In that scenario, consider purchasing renewable energy certificates to achieve Renewable Energy Certificate Zero Energy designation.

## RESOURCES

- Department of Energy, A Common Definition for Zero Energy Buildings. Defines Zero Energy Buildings and includes guidance on on-site renewable energy production parameters. [www.energy.gov/sites/prod/files/2015/09/f26/bto\\_common\\_definition\\_zero\\_energy\\_buildings\\_093015.pdf](http://www.energy.gov/sites/prod/files/2015/09/f26/bto_common_definition_zero_energy_buildings_093015.pdf)
- Department of Energy, Zero Energy Ready Home. A program that builds upon ENERGY STAR for Homes, along with proven Building America innovations and best practices. These homes are third-party verified. [energy.gov/eere/buildings/guidelines-participating-doe-zero-energy-ready-home](http://energy.gov/eere/buildings/guidelines-participating-doe-zero-energy-ready-home)
- Passive House Institute. An international standard for buildings with minimum energy consumption. [passivehouse.com/](http://passivehouse.com/)
- PHIUS. Committed to making high-performance passive building the mainstream market standard. The PHIUS+ standard has been cost-optimized by climate. PHIUS+ combines a thorough passive house design protocol with a stringent Quality Assurance and Quality Control program. [www.phius.org/home-page](http://www.phius.org/home-page) and [www.phaus.org](http://www.phaus.org)
- Living Building Challenge Net Zero Energy Building Certification. This program is operated by the International Living Future Institute, using the structure of the Living Building Challenge. Net Zero Energy Building Certification verifies that the building is truly operating as claimed, provides a platform for the building to inform other efforts throughout the world and accelerate the implementation of restorative principles, and celebrates a significant accomplishment and differentiates those responsible for the building's success in this quickly evolving market. [living-future.org/netzero](http://living-future.org/netzero)

## 5.5a

### **OPTIONAL** **5 POINTS MAXIMUM**

### **BASELINE** **FOR DISASTER RECOVERY HOUSING PROJECTS**

## **MOVING TO ZERO CARBON: ALL-ELECTRIC READY**

### **ELIGIBILITY**

Projects acquiring points through this criterion are not eligible for points from Criterion 5.5b.

### **RATIONALE**

A crucial part of reducing a property's carbon emissions is considering the emissions associated with the fuels that are used to power a home. Building an all-electric-ready property is a first step. Even if installing renewables is not feasible, the electric grid for a given property is not yet clean, and/or the price of operating an all-electric building in a given region is not yet cost-competitive, building an all-electric-ready property is a cost-effective means of preparing for future electrification.

### **REQUIREMENTS**

A project is eligible for points when, although it is using a combustion fuel source, the building has adequate electric service and has been designed and wired to allow for a seamless switch to electricity as a fuel source for the following uses throughout the project. *[1 point per use]:*

- space heating
- space cooling
- water heating
- clothes dryers
- equipment for cooking (including, but not limited to, ranges, cooktops, stoves, ovens)

### **RECOMMENDATIONS**

- See guidance on preparing for all electric in the 2021 International Energy Conservation Code.
- Utilize electricity for as many of the components listed above as possible; make the others electric-ready. From an emissions perspective, prioritize electrifying components that otherwise would use propane or heating oil. From a cost perspective, evaluate rates for various fuel sources and uses in your property. From a resident health perspective, prioritize electric equipment for cooking.
- Factor in the cost of potentially needing to upgrade electric service to the property against the cost of gas piping. Connect with your electric utility service provider to evaluate whether or not additional feeder lines and/or electrical panels are necessary.
- Consider installing heat pumps, of which effective cold climate models are available, to provide air conditioning as well as space heating. Heat pump water heaters and dryers are available; consider what electric technologies are appropriate for your property.



---

## RESOURCES

- Rocky Mountain Institute, The Economics of Electrifying Buildings. This analysis explores which building typologies can benefit financially from electrification. [rmi.org/insight/the-economics-of-electrifying-buildings/](https://rmi.org/insight/the-economics-of-electrifying-buildings/)
- Redwood Energy, Zero Emissions All-Electric Multifamily Construction Guide, 2019. [fossilfreebuildings.org/ElectricMFGuide.pdf](https://fossilfreebuildings.org/ElectricMFGuide.pdf)
- U.S. Energy Information Administration. U.S. households' heating equipment choices are diverse and vary by climate region. [www.eia.gov/todayinenergy/detail.php?id=30672&src=%E2%80%B9%20Consumption%20%20%20%20Residential%20Energy%20Consumption%20Survey%20\(RECS\)-f2](https://www.eia.gov/todayinenergy/detail.php?id=30672&src=%E2%80%B9%20Consumption%20%20%20%20Residential%20Energy%20Consumption%20Survey%20(RECS)-f2)
- Environmental Health Perspectives, Pollutant Exposures from Natural Gas Cooking Burners: A Simulation-Based Assessment for Southern California, Jennifer M. Logue, Neil E. Klepeis, Agnes B. Lobscheid, Brett Singer. Residential natural gas cooking burners can emit substantial quantities of pollutants, and they are typically used without venting range hoods. [ehp.niehs.nih.gov/1306673/](https://ehp.niehs.nih.gov/1306673/)
- Environmental Health Perspectives, Take Care in the Kitchen: Avoiding Cooking-Related Pollutants, Nate Seltenrich: [ehp.niehs.nih.gov/122-a154/](https://ehp.niehs.nih.gov/122-a154/) or Environmental Health Perspectives 122:A154– A159: [dx.doi.org/10.1289/ehp.122-A154](https://dx.doi.org/10.1289/ehp.122-A154)

## 5.5b

### **OPTIONAL** *15 POINTS*

## MOVING TO ZERO CARBON: ALL ELECTRIC

### **ELIGIBILITY**

Projects acquiring points through this criterion are not eligible for points from Criterion 5.5a.

### **RATIONALE**

An all-electric property's source operating emissions will be no worse than the emissions associated with the electric grid that provides power to the property. As grid sources of energy become cleaner, so will the emissions profile of the property. Removing combustion fuels from the property itself eliminates emissions associated with nonrenewable energy sources even if generating renewable power is not feasible on-site. And all-electric buildings allow for future grid flexibility, enabling a property to potentially take advantage of favorable rate structures.

Also consider the health implications. The process of combustion releases byproducts to which residents and staff may be exposed, and natural gas cooking burners have been shown to emit substantial quantities of pollutants. Eliminating combustion equipment from a building project eliminates the possibility of negative resident and staff health impacts due to exposure to combustion byproducts.

### **REQUIREMENTS**

No combustion equipment used as part of the building project; project is all-electric.

### **RECOMMENDATIONS**

- Factor in the cost of potentially needing to upgrade electric service to the property against the potential savings from avoiding gas piping. Connect with your electric utility service provider to evaluate whether or not additional feeder lines and/or electrical panels are necessary.
- Consider installing heat pumps, of which effective cold climate models are available, to provide air conditioning as well as space heating. Heat pump water heaters and dryers are available; consider what electric technologies are appropriate for your property.

---

## RESOURCES

- Rocky Mountain Institute, The Economics of Electrifying Buildings. This analysis explores which building typologies can benefit financially from electrification.  
[rmi.org/insight/the-economics-of-electrifying-buildings/](https://rmi.org/insight/the-economics-of-electrifying-buildings/)
- Redwood Energy, Zero Emissions All-Electric Multifamily Construction Guide, 2019.  
[fossilfreebuildings.org/ElectricMFGuide.pdf](https://fossilfreebuildings.org/ElectricMFGuide.pdf)
- Environmental Health Perspectives, Pollutant Exposures from Natural Gas Cooking Burners: A Simulation-Based Assessment for Southern California, by Jennifer M. Logue, Neil E. Klepeis, Agnes B. Lobscheid, Brett Singer. Residential natural gas cooking burners can emit substantial quantities of pollutants, and they are typically used without venting range hoods.  
[ehp.niehs.nih.gov/1306673/](https://ehp.niehs.nih.gov/1306673/)
- Environmental Health Perspectives, Take Care in the Kitchen: Avoiding Cooking-Related Pollutants, Nate Seltenrich: [ehp.niehs.nih.gov/122-a154/](https://ehp.niehs.nih.gov/122-a154/) or Environmental Health Perspectives 122:A154– A159: [dx.doi.org/10.1289/ehp.122-A154](https://dx.doi.org/10.1289/ehp.122-A154)

## 5.6

### **BASELINE**

*FOR ALL PROJECTS ADDING OR REPLACING HVAC EQUIPMENT*

## **SIZING OF HEATING AND COOLING EQUIPMENT AND DUCTS**

### **RATIONALE**

Appropriately sized equipment can save money, contribute to dehumidification, and prevent short-cycling that can lead to premature motor default.

### **REQUIREMENTS**

Size and select heating and cooling equipment in accordance with the Air Conditioning Contractors of America (ACCA) Manuals J, S and D or in accordance with the most recent ASHRAE Handbook of Fundamentals available at time of specification. If applicable use the most recent Manual LLH (Low Load Homes) to address low cooling and/or heating loads.

### **RECOMMENDATIONS**

- As buildings become more energy efficient and loads decrease, proper sizing and thoughtful approaches to year-round moisture control become more critical in all climate zones. Given projected changes in annual extreme heat days, properties in all climate zones have more reason to install air conditioning to ensure that residents are safe.
- Consider installing high-efficiency air filters or the capacity to accommodate them, per EPA guidance of Residential Air Filters.
- There are two types of loads to manage in a building: sensible and latent. Sensible capacity is the capacity to lower temperature, and latent capacity is the capacity to remove moisture from the air. Total capacity is sensible + latent. When sizing heating and cooling systems, we recommend sizing to the sensible load. If, in that scenario, the design shows that latent load will not be met by the equipment, install a dehumidifier to handle the latent load rather than sizing the air conditioner up. Sizing the air conditioner for the latent load will result in an oversized system that will have little latent control. Refer to Criterion 7.8 for further guidance.
- The HVAC designer generates a Manual J load calculation to determine heating and cooling loads of a particular project. A room-by-room Manual J is recommended, in order to properly determine airflows best suited for the space's associated heating and cooling loads. A Manual S is used to determine which space heating and cooling equipment best match the load of the project calculated per Manual J. The Manual J accounts for factors such as the dwelling unit's solar orientation, window design and insulation R-value, installation quality, building air leakage, and internal loads. Consult [www.acca.org/standards/software](http://www.acca.org/standards/software) for a list of software programs reviewed by ACCA to perform Manual J calculations.
- Manual D describes how to design a residential duct system. Given the amount of air that Manual



J dictates is needed for a particular space, the HVAC designer uses Manual D to determine how to design the duct system to achieve that flow rate.

- Manual LLH (Low Load Homes) is one of the newest ACCA manuals. LLH uses Manuals J, S, D, T, and others as a baseline and identifies equipment options and approaches to address low cooling and/or heating loads.
- Consider locating heating and cooling equipment and the distribution system within the building envelope to reduce thermal distribution losses—this is essential to achieving higher levels of property energy efficiency. Do not locate air handler or ductwork within the garage space (see Criterion 7.3 for more information).

## RESOURCES

- Air Conditioning Contractors of America. Manual J: Residential Load Calculation; Manual S: Residential Equipment Selection; Manual D: Residential Duct Design; Manual LLH: Low Load Homes. [www.acca.org/standards/](http://www.acca.org/standards/)
- Air Conditioning Contractors of America, HVAC Quality Installation Specification: Residential and Commercial Heating, Ventilating, and Air Conditioning Applications. The site also includes links to various articles and other ANSI and ACCA standards. [www.acca.org/standards/quality](http://www.acca.org/standards/quality)
- California Energy Commission, Procedures for HVAC System Design and Installation: This site provides an overview of good practices for designing and installing the HVAC system, as well as detailed strategies and measures for the “house as a system” approach to construction. [ww2.energy.ca.gov/title24/orc/hvac/2016\\_hvac.html](http://ww2.energy.ca.gov/title24/orc/hvac/2016_hvac.html)
- For additional information on duct sealing details. [www.energystar.gov/index.cfm?c=home\\_improvement.hm\\_improvement\\_ducts](http://www.energystar.gov/index.cfm?c=home_improvement.hm_improvement_ducts)

## 5.7

### **BASELINE** *FOR ALL PROJECTS PROVIDING APPLIANCES* **ENERGY STAR APPLIANCES**

#### **RATIONALE**

ENERGY STAR products meet strict energy-efficiency criteria set by EPA. These products reduce utility costs and greenhouse gas emissions.

#### **REQUIREMENTS**

If providing appliances, install ENERGY STAR clothes washers, dishwashers, and refrigerators.

If appliances will not be installed or replaced at this time, specify that, at the time of installation or replacement, ENERGY STAR models must be used via Criterion 8.1 and Criterion 8.4.

#### **RECOMMENDATIONS**

Note that this requirement may impact vendor selection if a property is leasing clothes washing equipment.

#### **RESOURCES**

When preparing project specifications, find **ENERGY STAR product information**, including model numbers and savings calculators. [www.energystar.gov/products/certified-products](http://www.energystar.gov/products/certified-products)

## 5.8

### **BASELINE**

**FOR NEW CONSTRUCTION AND SUBSTANTIAL REHAB PROJECTS AND NEW LIGHTING IN MODERATE REHAB PROJECTS**

## **LIGHTING**

### **RATIONALE**

Energy reductions through efficient lighting products contribute to lower utility costs and lower greenhouse gas emissions. LED lights are an energy-efficient alternative to standard incandescent and T-12 fluorescent lighting. ENERGY STAR LED lamps have now been available for a decade and exist for most intended use cases. Automatic lighting controls can significantly reduce lighting energy use. Battery backup in emergency lighting features allows for ease of egress during power blackouts.

### **REQUIREMENTS**

For all permanently installed lighting fixtures, interior and exterior, install high-efficiency lighting that is capable of meeting recommended light levels (weighted average footcandle) in the most current edition of the Illuminating Engineering Society Lighting Handbook.

Also, comply with all of the below:

- Recessed light fixtures installed as part of a building or dwelling unit air barrier shall be Insulation Contact Air-Tight (ICAT); exempt if installed entirely inside of or outside of an air barrier. Consider flush mount LED fixtures as an alternative.
- Lighting inside the building, but not in a dwelling unit, shall be controlled by occupancy sensors or automatic bi-level lighting controls; exempt if 24-hour consistent light levels are required by code.
- Lighting power density in dwelling units, measured in watts/square foot, is 1.1 or less.
- All exterior lighting shall meet the following specifications and have either motion sensor controls, integrative PV cells, photosensors, or astronomic time-clock operation to limit lighting when there is adequate daylight. Note, Dark Sky–approved “Friendly Fixture” certification automatically meets the following specifications.
  - Luminaires shall be fully shielded emitting no light above 90 degrees (with the exclusion of incidental light reflecting from fixture housing, mounts, and pole). The luminaire’s mounting hardware shall not permit mounting in any configuration other than those maintaining full shielding. Non-residential luminaires shall have an uplight rating of U0.
  - Fixture shall have no sag or drop lenses, side light panels or uplight panels.
  - Fixture shall employ warm-toned (3000K and lower) white light sources or may employ amber light sources or filtered LED light sources.

## RECOMMENDATIONS

- Consider incorporating daylighting practices throughout your project. Include controlled admission of natural light as well as a daylight-responsive lighting control system.
- Review ENERGY STAR product and design information regarding fixture and bulb selection and design.
- Utilize LED technology.
- Incorporate stairwell skylights as a multi-purpose design feature, providing light, egress, and ventilation.
- Install occupancy sensors in closets and rooms that will be occupied only intermittently. If installed in restrooms, position occupancy sensors to recognize the presence of someone in a toilet stall.
- Ensure that stairway lighting is consistent with or better than building corridor lighting to encourage use.
- Design outdoor lighting to eliminate light trespass from the project site and to minimize impact on nocturnal environments.
- Consider outdoor lighting levels that are appropriate to the context of the project. For instance, urban areas have existing exterior lighting, so the contribution of artificial light from housing may have less impact on the light levels and ecosystems in the area compared to those within rural areas. Presence of local animal species with certain sensitivities to light may also impact appropriate light levels.

## RESOURCES

- ENERGY STAR. For more information on lighting design and buying guidance: [www.energystar.gov/index.cfm?c=manuf\\_res.pt\\_lighting](http://www.energystar.gov/index.cfm?c=manuf_res.pt_lighting)
- The Lighting Research Center. This university-based, independent lighting research and education group provides objective and timely information about lighting technologies and applications, and about human response to light. [www.lrc.rpi.edu/](http://www.lrc.rpi.edu/)
- Whole Building Design Guide, Daylighting. [www.wbdg.org/resources/daylighting.php](http://www.wbdg.org/resources/daylighting.php)
- Illuminating Engineering Society of North America's Recommended Practice Manual. Lighting for Exterior Environments includes lighting design guidelines.
- International Dark-Sky Association. A recognized authority on light pollution, information on Dark-Sky-approved fixtures can be found online at [www.darksky.org/outdoorlighting](http://www.darksky.org/outdoorlighting)
- Lamp Recycle lists locations where fluorescent lamps and ballasts may be taken for recycling. [www.lamprecycle.org](http://www.lamprecycle.org)

## 5.9

### **OPTIONAL** *8 POINTS*

# RESILIENT ENERGY SYSTEMS: FLOODPROOFING

## **ELIGIBILITY**

Rehab projects located in Special Flood Hazard Areas designed by FEMA are required through Criterion 2.1 to adhere with ASCE 24, which exceeds the below criteria. Those projects are not eligible for these optional points.

## **RATIONALE**

When raising services, equipment, and building portions above design flood level is not possible, dry floodproof such services and spaces to better ensure building service in the case of a major flood event. The first and lower floors of buildings are often at risk because they are below flood level. Any essential building equipment should be located elsewhere if flooding is a risk. Submersion of electrical utility services to the first point of switch disconnect is a safety concern and can lead to excessive or irreparable damage to both utility and building systems and increase the recovery time for such systems.

## **REQUIREMENTS**

Conduct floodproofing, including perimeter floodproofing (barriers /shields), of lower floors.

Design and install building systems in such a way that, in the case of an emergency, the operation of these systems will not be grossly affected:

- Locate any and all central space and water heater equipment above design flood elevations.
- Locate the service disconnect at a readily accessible location above the design flood elevation.
- Locate at least one exit door above the design flood elevation.
- On plan sets, identify water entry points at basements and foundation walls and demarcate all penetrations, wall assemblies, and doors/openings to ensure that future renovations do not compromise the integrity of floodproof construction.

## **RECOMMENDATIONS**

- Project teams should, in accordance with Criterion 1.1, identify whether or not floods are of concern for the project in question. Consider likelihood of flooding from storm events.
- Project teams will need to identify suitable space, with accessible entry, for locating this equipment above design flood elevation.
- See ASCE 24-05 Flood Resistant Design and Construction for further guidance regarding design and placement of building services.

---

## RESOURCES

- Urban Green, Building Resiliency Task Force Full Report, June 2013.  
[issuu.com/urbangreen/docs/brtf\\_full\\_report#/freeSignupNamePassword](https://issuu.com/urbangreen/docs/brtf_full_report#/freeSignupNamePassword)
- ASCE 24-05 Flood Resistant Design and Construction, 2010.  
[www.fema.gov/media-library/assets/documents/14983?id=3515](http://www.fema.gov/media-library/assets/documents/14983?id=3515)
- U.S. Army Corp of Engineers, St. Paul District. Flood-Fight Handbook: Preparing for a Flood, 2009.  
[www.wsask.ca/Global/Lakes%20and%20Rivers/Flood%20Watch/Flood%20Fight%20Handbook.pdf](http://www.wsask.ca/Global/Lakes%20and%20Rivers/Flood%20Watch/Flood%20Fight%20Handbook.pdf)
- Enterprise's Multifamily Resilience Manual includes more than a dozen strategies and specific guidance for building property resilience in the event of an emergency, including floodproofing strategies.  
[www.enterprisecommunity.org/news-and-events/news-releases/multifamily-building-resilience-manual](http://www.enterprisecommunity.org/news-and-events/news-releases/multifamily-building-resilience-manual)

## 5.10

### **OPTIONAL** **8 POINTS**

## RESILIENT ENERGY SYSTEMS: CRITICAL LOADS

### **RATIONALE**

With more intense storms, flooding, wildfires, and heat waves forecast with climate change, the frequency and duration of power outages may increase. So-called “islandable” electrical systems offer a significant level of resilience in such situations for supplying power to critical building systems when the grid is not able to provide power.

### **REQUIREMENTS**

Provide adequate emergency power to serve certain systems in the project. Size the system to satisfy at least three of the most critical following energy loads of the project for at least four consecutive days, 24 hours per day. Consider a larger system if needed to satisfy extended power outages and/or to hold all occupants and staff on an emergency basis for a power outage during extreme heat or cold.

Critical energy loads:

- Operation of electrical components of fuel fired heating systems
- Operation of a fan sufficient to provide emergency cooling if mechanical air conditioning equipment cannot operate
- Operation of water pumps if needed to make potable water available to occupants
- Lighting level a minimum of 3 footcandles in all building spaces to define a path of egress to all required exits and to a distance of 10 feet on the exterior
- One location for every 500 square feet that provides a minimum of 30 footcandles measured 30 inches above the floor
- At least one functioning electrical receptacle per 250 square feet of occupied space
- Sufficient power for operation of critical medical equipment for residents
- Operation of cable modem and wireless router or other means of providing online access within the building, if applicable
- Operation of one elevator in building, if applicable

### **Option 1**

Islandable PV system with battery storage and a system to switch to battery backup when the electric grid goes down.

OR

### **Option 2**

Efficient generator that will offer reliable electricity for critical circuits during power outages.

## **RECOMMENDATIONS**

- Prioritize which electrical equipment will run on backup power so buildings can remain habitable during extended blackouts. Because cogeneration and solar power systems are always in use, they can be more reliable than generators that are turned on only during emergencies. In substantial rehab projects where the installation of a PV system is not feasible, a generator may be used as a backup power source.
- Prioritize emergency systems such as egress lighting, extended life safety systems (fire alarms), water, parking egress, improved habitability for mobility-impaired occupants (elevator car operation), small critical heating and cooling loads, and convenience power for building occupants (charging stations).
- A bi-modal solar system that can both feed power into the electric grid (net-metering) and shunt power to and from a battery bank offers great flexibility and resilience (including power at night during power outages).
- Where a permanent connection is being made for a portable generator, a disconnecting means and overcurrent protection should be provided at the point of connection. For a temporary generator hookup, the project should provide easy access to an electrical connection point. Connections shall be administered by qualified people who maintain and supervise the installation.
- If utilizing a gas-fired generator, consider the need to store an adequate amount of fuel.

## **RESOURCES**

- Enterprise Community Partners, Multifamily Resilience Manual. Includes more than a dozen strategies and specific guidance for building property resilience in the event of an emergency, including backup power strategies.  
[www.enterprisecommunity.org/news-and-events/news-releases/multifamily-building-resilience-manual](http://www.enterprisecommunity.org/news-and-events/news-releases/multifamily-building-resilience-manual)
- Database of State Incentives for Renewables & Efficiency (DSIRE). The DOE and the North Carolina Clean Energy Technology Center developed this database to collect information on state financial and regulatory incentives (e.g., tax credits, grants, and special utility rates) designed to promote the application of renewable energy technologies. DSIRE also offers additional features, such as preparing and printing reports that detail the incentives on a state-by-state basis. [www.dsireusa.org](http://www.dsireusa.org)
- Urban Green, Building Resiliency Task Force Full Report, Backup Power Chapter, June 2013.  
[issuu.com/urbangreen/docs/brtf\\_full\\_report#/freeSignupNamePassword](http://issuu.com/urbangreen/docs/brtf_full_report#/freeSignupNamePassword)



## 5.11

### OPTIONAL 5-10 POINTS

## ELECTRIC VEHICLE CHARGING

### RATIONALE

Nationally, one million electric vehicles were on the road by September of 2018, but that number is expected to grow to close to 19 million or 7 percent of all vehicles by 2030. Iowa's share of this market is small but growing. In June 2016, there were an estimated 1,107 registered electric vehicles in Iowa. As of December 30, 2018, the Iowa DOT estimated 3,007 electric vehicles in Iowa, with 1,043 of these representing all electric and 1,964 plug-in hybrid vehicles.

“It’s my feeling that you give some- body a good place to live... it will just change their lives forever.”

Resident of Enterprise Green Communities property

### REQUIREMENTS

#### *Option 1 [5 points]*

Install panel capacity and raceway ( $\geq$  size 1) to support future build-out of EV charging with 208/240 V, 40-amp circuits. Identify the overcurrent protective device space(s) on circuit directory as “EV CAPABLE.”

#### *Option 2 [10 points]*

Residential projects  $\geq$  2 units install  $\geq$  1 active electric vehicle charging station. For multifamily and commercial projects install  $\geq$  2 active charging stations for first 25 parking spaces and 10% of all parking spaces  $>$  25 (round up).

### RECOMMENDATIONS

- For multifamily and commercial projects, run the necessary raceways and conduit to support future electric vehicle charging station installation.
- For neighborhood development projects, identify opportunities for neighborhood shared EV charging.
- Check for any local codes pertaining to electric vehicle charging.

### RESOURCES

- Iowa Energy Office. Advancing Iowa’s Electric Vehicle Market. [iowaeda.com/userdocs/programs/AdvancingIowasElectricVehicleMarketReport.pdf](http://iowaeda.com/userdocs/programs/AdvancingIowasElectricVehicleMarketReport.pdf)
- Iowa Energy Office. Charging Forward: Iowa’s Opportunities for Electric Vehicle Infrastructure Support. [iowaeda.com/userdocs/news/IEDA\\_EVRpt\\_022019.pdf](http://iowaeda.com/userdocs/news/IEDA_EVRpt_022019.pdf)
- Department of Energy. Charging at Home. [www.energy.gov/eere/electricvehicles/charging-home](http://www.energy.gov/eere/electricvehicles/charging-home)
- Greentech Media. What to Consider When Buying and Installing a Home Electric Vehicle Charging Station. [www.greentechmedia.com/articles/read/buying-and-installing-a-home-electric-vehicle-charging-station](http://www.greentechmedia.com/articles/read/buying-and-installing-a-home-electric-vehicle-charging-station)

## 5.12

### BASELINE ADVANCED FRAMING

#### RATIONALE

Advanced framing is an often-underutilized tool in the contractor's toolbox. The Department of Energy describes advanced framing and its benefits best. "Advanced house framing, sometimes called optimum value engineering (OVE), refers to framing techniques designed to reduce the amount of lumber used and waste generated in the construction of a wood-framed house. These techniques boost energy efficiency by replacing lumber with insulation material while maintaining the structural integrity of the home. Advanced framing improves the whole-wall R-value by reducing thermal bridging (thermal flow that occurs when materials that are poor insulators displace insulation) through the framing and maximizing the insulated wall area. Fully implementing advanced framing techniques can result in materials cost savings of up to \$500 or \$1,000 (for a 1,200- and 2,400-square-foot house, respectively), labor cost savings of between 3% and 5%, and annual heating and cooling cost savings of up to 5%."

#### REQUIREMENTS

##### *Advanced Framing*

- Follow Advanced Framing (Optimum Value Engineering) best practices for all framing.
- Designing on two-foot modules to make the best use of common sheet sizes and reduce waste and labor.
- Spacing wall studs up to 24 inches on center.
- Spacing floor joists and roof rafters up to 24 inches on center.
- Using two-stud corner framing and inexpensive drywall clips or scrap lumber for drywall backing instead of studs.
- Eliminating headers in non-load-bearing walls.
- Using in-line framing in which floor, wall, and roof framing members are vertically in line with one another and loads are transferred directly downward.
- Using single lumber headers and top plates when appropriate.
- Use truss uplift clips when installing trusses and do not attach ceiling drywall near corners.

---

## RESOURCES

- Building Science Corporation. 2 x 6 Advanced Frame Wall Construction. Building Science Corporation provides a wealth of information on Optimum Value Engineering (Advanced Framing) to reduce framing material costs and improve wall performance. [www.buildingscience.com/documents/enclosures-that-work/high-r-value-wall-assemblies/copy\\_of\\_advanced-frame-wall-construction](http://www.buildingscience.com/documents/enclosures-that-work/high-r-value-wall-assemblies/copy_of_advanced-frame-wall-construction)
- APA – The Engineered Wood Association provides for free the Advanced Framing Construction Guide. [www.apawood.org/advanced-framing](http://www.apawood.org/advanced-framing)
- See advanced framing images and resource links below.

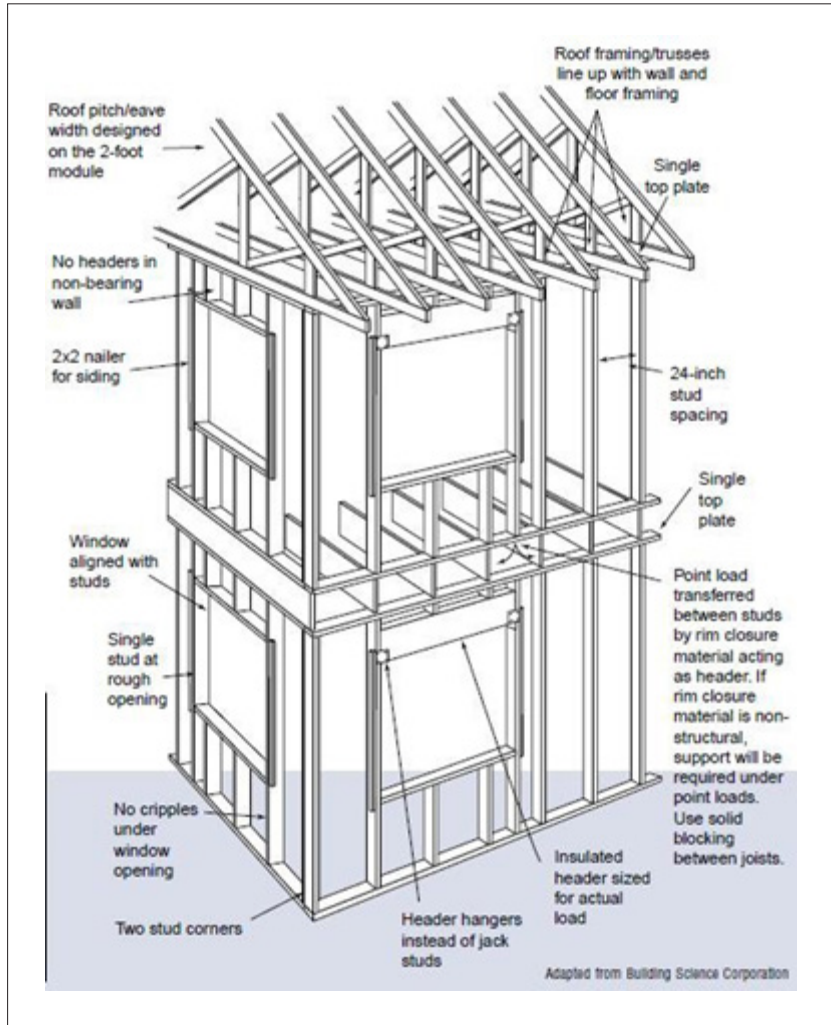

Advanced Framing

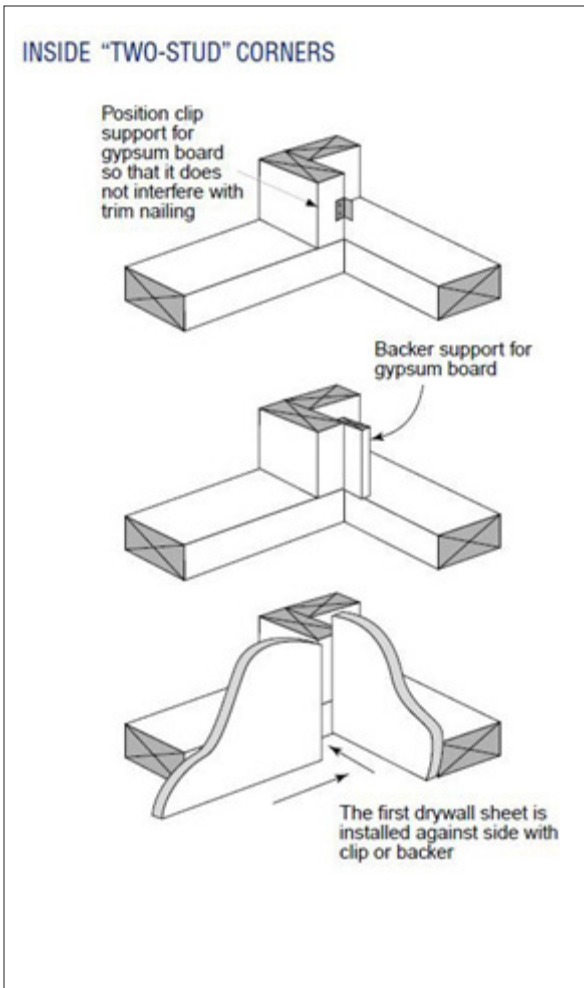

Two-Stud Corner

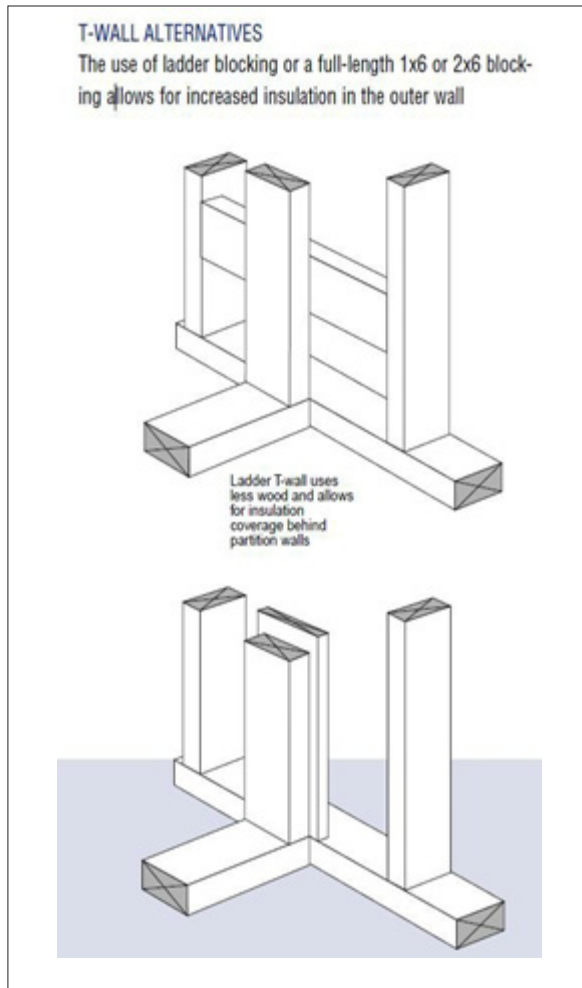

T-Wall

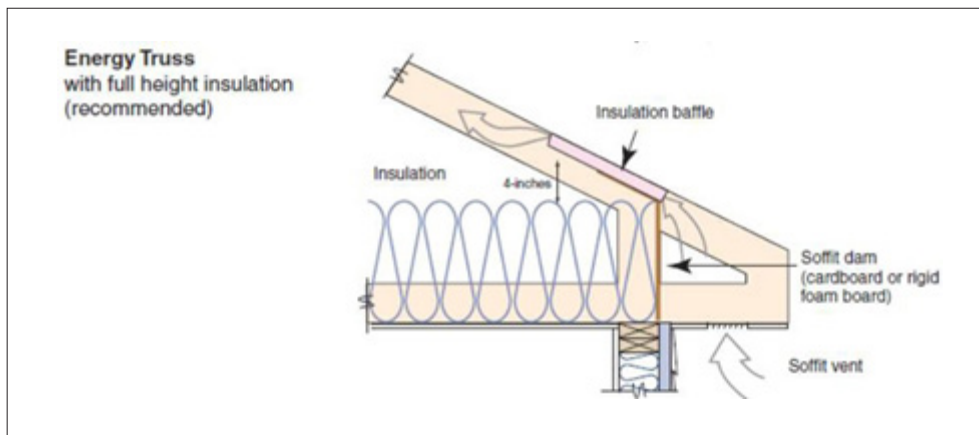

(Image: Building America Solution Center)

**Raised-Heel Truss**

[www.apawood.org/raised-heel-trusses](http://www.apawood.org/raised-heel-trusses)

## 5.13

### **OPTIONAL** **5-15 POINTS**

## FORTIFIED ROOFS AND HOMES

### **RATIONALE**

FORTIFIED is a voluntary construction and re-roofing program of the Insurance Institute for Business & Home Safety. The FORTIFIED standards are designed to strengthen homes and commercial buildings against severe weather such as high winds, hail, and even tornadoes. Iowa is geographically located in an area of the country susceptible to natural disasters caused by high winds, hail and tornadoes. In some states, insurance companies are beginning to offer discounted premiums to homes built to the FORTIFIED roof, FORTIFIED Silver, or FORTIFIED Gold standard.

### **REQUIREMENTS**

FORTIFIED Roof - When re-roofing an existing building or constructing a new building, achieve FORTIFIED Roof (High Wind & Hail) certification. *[5 points]*

FORTIFIED Silver - When constructing a new building or home, achieve FORTIFIED Silver certification. *[10 points]*

FORTIFIED Gold – When constructing a new building or home, achieve FORTIFIED Gold certification. *[15 points]*

### **RECOMMENDATIONS**

Involve a structural engineer in your project design as soon as possible.

Involve a FORTIFIED Evaluator in your project early so they can document and verify the entire process.

### **RESOURCES**

- FORTIFIED Standard - [fortifiedhome.org/technical-documents](https://fortifiedhome.org/technical-documents)
- FORTIFIED Multifamily and Commercial Standard - [fortifiedhome.org/fortified-commercial](https://fortifiedhome.org/fortified-commercial)
- FORTIFIED educational tools - [fortifiedhome.org/educational-tools/?v=1662133679620](https://fortifiedhome.org/educational-tools/?v=1662133679620)
- FORTIFIED Wise™ University - [www.fortifiedwise.com](http://www.fortifiedwise.com)
- FORTIFIED marketing resources for developers and builders - [fortifiedhome.org/marketing](https://fortifiedhome.org/marketing)



## MATERIALS

INTRODUCTION CRITERIA  
CHECKLIST

- 1 INTEGRATIVE DESIGN
- 2 LOCATION +  
NEIGHBORHOOD FABRIC
- 3 SITE IMPROVEMENT
- 4 WATER
- 5 OPERATING ENERGY
- 6 MATERIALS**
- 7 HEALTHY LIVING  
ENVIRONMENT
- 8 OPERATIONS,  
MAINTENANCE  
+ OCCUPANT  
ENGAGEMENT

APPENDIX

ENACTING HEALTH AND ENVIRONMENTAL LENSES WHEN PURCHASING, INSTALLING, AND DISPOSING OF BUILDING MATERIALS WILL IMPROVE THOSE CONDITIONS IN THE PROPERTY



## 6.1

### **OPTIONAL** **8 POINTS MAXIMUM**

# INGREDIENT TRANSPARENCY FOR MATERIAL HEALTH

## **RATIONALE**

As occupants of buildings, we all are exposed to the chemicals that make up the built environment. People who build, and residents of communities where building products are manufactured, can be exposed at higher rates. We all are better served by knowing what chemicals we are exposed to and what health hazards may be associated with those chemicals. In particular, people responsible for the design, construction, and operation of buildings are in a position to act upon this information and avoid known and potential hazards. Public ingredient disclosure for building materials allows project teams to make more-informed choices.

Full disclosure of content and known hazards for products is the first step toward optimizing buildings, enabling us to avoid construction of homes with hazardous chemicals. Once full content information is publicly disclosed, staff can work to assess the chemicals and work toward supplying, manufacturing, and specifying products where all chemicals are assessed to be of relatively low hazard. Until then, regrettable substitutions—replacing a well-studied hazardous chemical with a less studied chemical whose hazards are not yet known, if that chemical is later found to be equally or more hazardous than the targeted chemical—are likely. Full disclosure enables high-priority chemical avoidance and moves the needle toward project optimization.

Declare labels and Health Product Declarations (HPDs) are standardized formats for a product manufacturer to disclose a product's chemical content; third-party-verified HPDs and Declare labels have had those chemical inventories reviewed by an additional party that has been approved by the program implementers for HPD and Declare. HPDs and Declare labels that are third-party verified are indicated as such on the declaration or label. Third-party verifications provide an additional level of confidence in the completeness of the inventory provided.

## **REQUIREMENTS**

Specify and install products that have inventories that have been publicly disclosed where content is characterized and screened using health hazard lists or restricted substances lists to 1,000 ppm or better. Note that “better than” 1,000 ppm is a number lower than 1,000 ppm (e.g., screening to 100 ppm is better than to 1,000 ppm).

There are several ways of accruing points within this criterion. They are listed in order of increasing rigor below. Any combination of the below point pathways may be used for a project if several of the project's products are compliant. However, a product may be counted for points only once within this criterion.





- 1 point per 5 installed Declare or HPD products from at least three different product categories
- 1 point per 2 installed Declare or HPD products in any of these high-priority product categories: adhesives, sealants, windows
- 1 point per each product with third-party verified HPD or third-party verified Declare label
- 2 points per each product with third-party verified HPD or third-party verified Declare label in any of these high-priority product categories: adhesives, sealants, windows

We use the terms “category” and “product category” to mean the general category for a product, such as building insulation or multipurpose sealant. We use the terms “product type” and “type of product” to refer to a subgroup within the category that is more general than a specific product. For example, a type of multipurpose sealant would be an acrylic latex sealant, and a type of building insulation would be expanded cork board insulation. A specific product would be a specific brand of a product type.

For the first point pathway above, for instance, three compliant flooring products, one insulation product and one drywall product could achieve a total of 1 point—but four flooring products and one insulation product would not achieve any.

## RECOMMENDATIONS

The number and variety of products with public ingredient disclosure is growing. Ask your suppliers to commit to transparency throughout their supply chain.

## RESOURCES

- The Health Product Declaration (HPD) is a standardized format for manufacturer disclosure of product content, emissions and health hazards associated with the content. Manufacturers voluntarily use the format and may distribute it as they do Safety Data Sheets or Technical Data Sheets. The Health Product Declaration Collaborative maintains the HPD Open Standard and a list of tool providers who offer databases of HPDs: [hpdcollaborative.org/](http://hpdcollaborative.org/). Find publicly available HPDs in the HPD Public Repository here: [hpdrepository.hpd-collaborative.org/Pages/Results.aspx](http://hpdrepository.hpd-collaborative.org/Pages/Results.aspx). Find information about third-party verified HPDs here: [www.hpd-collaborative.org/tpv-program/](http://www.hpd-collaborative.org/tpv-program/)
- Declare is a transparency platform and product database for the materials marketplace. Find Declare labels in the Declare Database: [living-future.org/declare/](http://living-future.org/declare/). Find information about third-party verified Declare labels here: [living-future.org/declare/declare-about/#third-party-verification](http://living-future.org/declare/declare-about/#third-party-verification)
- The mission of the Healthy Building Network (HBN) is to advance human and environmental health by improving hazardous chemical transparency and inspiring product innovation. HomeFree is HBN’s national initiative supporting affordable housing leaders who are improving human health by using less toxic building materials. The HomeFree website provides healthy building material recommendations and resources for understanding and requesting public ingredient disclosure. [homefree.healthybuilding.net/transparency](http://homefree.healthybuilding.net/transparency)
- Building Clean, an initiative of the BlueGreen Alliance Foundation, has various resources created for the affordable housing community. The Certified Products Database is a consolidated database of more than 15,000 building products. Search for products with any combination of chemical hazard optimization, low-VOC certifications and/or ingredient disclosures, including Red List-free, Cradle to Cradle (C2C), Living Building Challenge (LBC) Compliant, FloorScore, GREENGUARD, Green Label Plus, Indoor Advantage, Green Seal, Living Product Certification, HPD, Product Lens, and Declare. Certified Products Database. [buildingclean.org/building/products/flooring](http://buildingclean.org/building/products/flooring)



## 6.2

### **OPTIONAL** **3 POINTS MAXIMUM**

# RECYCLED CONTENT AND INGREDIENT TRANSPARENCY

## **RATIONALE**

Use of building products with recycled content reduces the negative environmental impact resulting from extraction and processing of virgin materials. However, reuse of materials should be done with care to minimize negative health implications.

The need for content disclosure applies not just to virgin materials, but also to recycled content, which can contain legacy contaminants. This hazardous content can be unintentionally incorporated into new products, further exposing people through both the recycling process and during the product's use. Removing hazardous materials from products also increases their future value as recycled content, improving the potential for circular manufacturing. Sometimes a complete understanding of the chemical makeup of recycled content is difficult to achieve. The first step toward ensuring safe recycled content is an understanding of the source of the recycled content. This allows for consideration of what hazardous chemicals are likely to be present and prioritized screening to avoid those hazardous chemicals.

## **REQUIREMENTS**

Use building products that feature recycled content and disclosure about that recycled content.

The building product must make up 75% (by weight or cost) of a product category for the project and must be composed of at least 25% post-consumer recycled content to be eligible for this criterion.

For each building product, provide a public disclosure of the origin of the post-consumer recycled content (e.g., PVC wire and cable scrap; cathode ray tubes; vehicle tires) and if/how the recycled content has been screened for or avoids sources of heavy metals. For this criterion, heavy metals are defined as compounds containing arsenic, cadmium, hexavalent chromium, lead, or mercury.

The following table provides a sample of product categories and example product types that a team can incorporate for optional points. Each building product that meets the requirements of this criterion is worth 1 point.

We use the terms “category” and “product category” to mean the general category for a product, such as building insulation or multipurpose sealant. We use the terms “product type” and “type of product” to refer to a subgroup within the category that is more general than a specific product. For example, a type of multipurpose sealant would be an acrylic latex sealant and a type of building insulation would be expanded cork board insulation. A specific product would be a specific brand of a product type.



PRODUCT CATEGORY	PRODUCT TYPE EXAMPLES
Framing	Wood, concrete, steel, aluminum
Siding or masonry	Wood, metal, masonry
Flooring (non-structural)	Linoleum, cork, bamboo, reclaimed wood, sealed concrete, carpet
Paving	Cement slab (Urbanite)
Roofing	Wood shingles, asphalt shingles, tile, metal, roofing membranes
Insulation	Fiberglass batt, cellulose, rigid panel
Sheathing	Plywood, OSB

Note: The list above is a partial list and does not include all possible building product types; mechanical, electrical, and plumbing components cannot be included in this calculation.

## RECOMMENDATIONS

Consider the incorporation of recycled-content building materials from the early stages of project design.

## RESOURCES

- SCS Global Services Recycled Content Certification evaluates products made from pre-consumer or post-consumer material diverted from the waste stream. Certification measures the percentage of recycled content for the purpose of making an accurate claim in the marketplace. [www.scsglobalservices.com/services/recycled-content-certification](http://www.scsglobalservices.com/services/recycled-content-certification)
- The mission of the Healthy Building Network (HBN) is to advance human and environmental health by improving hazardous chemical transparency and inspiring product innovation. HBN provides in-depth research reports on various common recycled feedstocks used in building materials and potential hazardous content therein. [healthybuilding.net/reports/category/1-optimized-recycling](http://healthybuilding.net/reports/category/1-optimized-recycling)



## 6.3

### OPTIONAL 8 POINTS MAXIMUM

## CHEMICAL HAZARD OPTIMIZATION

### RATIONALE

While public ingredient disclosure, incentivized through Criteria 6.1 and 6.2, allows project teams to make more informed choices, Criterion 6.3 rewards project teams for choosing products that minimize human and environmental health hazards.

### REQUIREMENTS

Install products that have third-party verification of optimization to 100 ppm or better.

There are several ways of accruing points within this criterion. Any combination of the point pathways below may be used for a project. However, a product may be counted only once within this criterion. Projects are permitted to acquire points for a given product in both Criteria 6.1 and 6.2 and in Criterion 6.3. There are multiple levels on the path toward full assessment and optimization. Each successive level below provides progress toward a fully optimized product. Not all of the certifications/declarations/labels within a given optimization level below are equivalent, but within a level they provide a relatively similar degree of rigor and assurance about the health hazards associated with the product contents.

#### **1 point per three installed products with screening level optimization for 100% of content to 100ppm, verified by a third party**

- Third-party verified Declare Red List-free
- Third-party verified Declare Living Building Challenge (LBC) Compliant (if the only exemption is the proprietary ingredient exemption)
- Cradle to Cradle (C2C) Basic or Bronze; C2C Material Health Certificate Basic or Bronze
- GreenScreen Certified Bronze-100
- Third-party verified HPD with no List Translator (LT) score of LT-1 or publicly available Benchmark (BM) score of BM-1

#### **1 point per two installed products with assessment level optimization for 95% of content to 100ppm, verified by a third party**

- GreenScreen Certified Silver-95
- C2C Silver
- Living Product Challenge with Transparent Materials Health, to 95%



**1 point per one installed product with assessment level optimization for 100% of content to 100ppm, verified by a third party**

- Living Product Challenge with Transparent Material Health, to 100%
- C2C Gold or Platinum C2C Material Health Certificate Gold or Platinum or C2C Material Health Certificate Silver showing 100% assessed
- GreenScreen Certified Silver-100 or Gold
- Third-party verified HPD where each chemical in the product is assessed and the product is free of GreenScreen Benchmark (BM) -1 chemicals

## RECOMMENDATIONS

- All products, and product labels, are not equal. Be aware that when selecting products in order to avoid a given characteristic, there is a chance of selecting an alternate product with an equally poor chemical inventory that has not yet been characterized or has not been fully assessed—leading to a regrettable substitution. To minimize the likelihood of this, consider choosing products that have been fully characterized and assessed for human health hazards.
- Refer to dynamic lists of products whenever possible. The sector does not yet use standard naming conventions, and product specifiers, manufacturers, and suppliers are all simultaneously revealing more information about product content and impact.

## RESOURCES

- Green Screen List Translator™. [www.greenscreenchemicals.org/learn/greenscreen-list-translator](http://www.greenscreenchemicals.org/learn/greenscreen-list-translator)
- Declare is a transparency platform and product database for the materials marketplace. Through Declare, project teams can search for Declare Red List-free and Declare Living Building Challenge Compliant products: [living-future.org/declare/](http://living-future.org/declare/). Living Product Certified products can be found in the LPC database: [living-future.org/lpc/case-studies/](http://living-future.org/lpc/case-studies/)
- Cradle to Cradle (C2C), Certified Products and Material Health Certificate products. [www.c2ccertified.org/](http://www.c2ccertified.org/)
- GreenScreen is a universally recognized tool that identifies hazardous chemicals and safer alternatives. [www.greenscreenchemicals.org/](http://www.greenscreenchemicals.org/)
- The HPD is a standardized format for manufacturer disclosure of product content, and emissions and health hazards associated with the content. Manufacturers voluntarily use the format and may distribute it as they do Material Safety Data Sheets or Technical Data Sheets. The HPD Collaborative maintains the HPD Standard and a list of tool providers who offer databases of HPDs. [hpdcollaborative.org/](http://hpdcollaborative.org/)
- Building Clean, an initiative of the BlueGreen Alliance Foundation, has various resources created for the affordable housing community. The Certified Products Database is a consolidated database of more than 15,000 building products. Search for products with any combination of chemical hazard optimization, low-VOC certifications and/or ingredient disclosures, including Red List-free, C2C, LBC Compliant, FloorScore, GREENGUARD, Green Label Plus, Indoor Advantage, Green Seal, Living Product Certification, HPD, Product Lens, and Declare. [buildingclean.org/building/products/flooring](http://buildingclean.org/building/products/flooring)



## 6.4

### **BASELINE AND OPTIONAL** *15 POINTS MAXIMUM*

## HEALTHIER MATERIAL SELECTION

### **RATIONALE**

On the path from disclosure to fully optimized products, an intermediate step is avoiding key chemicals of concern. These can come in the form of volatile organic compounds (VOCs) and also less volatile chemicals that escape from products over longer periods of time. Paints, coatings, primers, adhesives, and sealants may release VOCs, particularly when newly applied or when wet. Similarly, new carpets, padding, and flooring adhesives also release VOCs that may pose health hazards to residents and installers. Exposure to individual VOCs and mixtures of VOCs can cause or aggravate health conditions, including allergies, asthma, and irritation of the eyes, nose, and airways. Some VOCs, like formaldehyde, are associated with health impacts like cancer. However, no health-based standards for indoor non-occupational exposure have been set. The South Coast Air Quality Management District (SCAQMD) thresholds below ensure that products have limited VOC content, and the California Department of Public Health (CDPH) emission standard (formerly called California 01350) ensures that products are verified to have limited VOC emissions, for the specific VOCs tested. Use of products meeting these SCAQMD and CDPH requirements in interior applications is a critical step to reduce VOC exposure and health harm.

Beyond VOCs, building products may contain other chemicals of concern that can be avoided, for instance:

- Alkylphenol ethoxylates (APEs) are chemicals of concern for their endocrine-disrupting properties. APEs are common in paints, although a phase-out is underway in the U.S. and many products without APEs are available.
- Isocyanates are asthmagens used in spray polyurethane foam (SPF), fluid applied floors, and polyurethane high-performance coatings.
- Phthalates are used to make PVC/vinyl flexible. They have been largely phased out in vinyl flooring in the U.S., and safer alternatives are widely available. They are also found in some sealants, where the transition to safer alternatives is still underway.
- Many hazardous chemicals, including bisphenol A, go into making epoxy materials such as fluid applied floors and epoxy high-performance paints and other epoxy coatings applied on-site.
- Formaldehyde, a carcinogen, is used in binders for some high-density fiberglass insulation, most mineral wool insulation, and in plywood, particleboard, and other composite woods.



## REQUIREMENTS

Use products that comply with the specifications below.

PRODUCT CATEGORY	Baseline	OPTIONAL	RECOMMENDATIONS
All interior paints, coatings, primers, and wallpaper	<p>VOC content less than or equal to the thresholds provided by the most recent version of SCAQMD 1113 available at time of product specification for all interior paints, coatings and primers.</p> <p>VOC emissions verified as compliant with CDPH Standard Method for all wall finish paints.</p> <p>All wallpaper, phthalate free</p>	<p>1 point per APE-free paint, coating and/or primer</p> <p>1 point per CDPH-compliant coating and/or primer (excluding wall finish paints)</p> <p><i>[2 points maximum]</i></p>	<p>See Appendix L for table of SCAQMD 1113 VOC limits</p> <p>For wall finish paints compliant with the Baseline CDPH specification, seek those certified to Master Painters Institute (MPI) X-Green, Green Wise Gold, GREENGUARD Gold, SCS Indoor Advantage Gold, and Berkeley Analytical ClearChem. GS-11 paints comply with the optional APE-free criterion, as do Red List-free products.</p>
All interior adhesives and sealants	<p>VOC content less than or equal to the thresholds provided by the most recent version of SCAQMD 1168 available at time of product specification for all interior adhesives and sealants.</p>	<p>Use of sealants that do not contain orthophthalate plasticizers. Use of adhesives that are CDPH compliant.</p> <p><i>[1 point per compliant product, 2 points maximum]</i></p>	<p>See Appendix L for table of SCAQMD 1168 VOC limits</p> <p>Orthophthalate plasticizers are common in polyurethane and modified polymer sealants. While not common, they may also be found in some acrylic latex or siliconized acrylic sealants. Verify that specified sealants are phthalate-free.</p> <p>Minimize the need for adhesives when possible. For instance, finger-joints and mechanical fasteners do not contain chemicals of concern.</p>



PRODUCT CATEGORY	Baseline	OPTIONAL	RECOMMENDATIONS
Flooring	<p>All flooring products (whether carpet or hard surface) must comply with CDPH emission requirements.</p> <p>No flexible PVC with phthalates may be installed, whether the phthalates were intentionally added or added via recycled content.</p> <p>No carpet in the project may be installed in building entryways, laundry rooms, bathrooms, kitchens/ kitchenettes, or utility rooms.</p> <p>Fluid applied finish floors may only be installed in non-occupied spaces, such as mechanical rooms.</p>	<p>The project complies with one of the following options:</p> <ul style="list-style-type: none"> <li>• Absence of vinyl-flooring throughout the project</li> <li>• Absence of carpet throughout the project</li> <li>• All project flooring assemblies (adhesive, sealant, flooring product) are Red List-free</li> </ul> <p><i>[3 points]</i></p> <p>If using carpet, specify those that do not use a fluorinated (PFAS) stain repellent. <i>[1 point]</i></p>	<p>Common flooring product labels that meet or exceeded the Baseline CDPH emission requirement include FloorScore, GREEN- GUARD Gold, SCS Indoor Advantage Gold, Berkeley Analytical ClearChem, and Carpet Rug Institute Green Label Plus (CRI+).</p> <p>In place of vinyl or other PVC-based resilient flooring, consider salvaged hardwoods, natural linoleum, rubber, cork, other PVC-free resilient flooring, ceramic or stone tile, sealed concrete, or pre-finished solid wood flooring. Pre-finished products, compared to those finished on site, keep potential exposures lower through a more controlled environment during finishing.</p> <p>If possible, use a floor system that can feature mechanical attachments (e.g., nails, floating wood flooring) instead of glues.</p> <p>This approach makes flooring easier to recycle in the future.</p>
Insulation	<p>If fiberglass or mineral wool batts are used, these must be formaldehyde-free.</p>	<p>The project does not include any two-part spray polyurethane foam. <i>[2 points]</i></p> <p>The project uses board insulation that does not contain halogenated flame retardants. <i>[3 points]</i></p>	<p>Alternative insulation products include recycled cotton, cellulose, wool, and blown fiberglass. All major U.S. manufacturers of residential fiberglass batt insulation have transitioned to formaldehyde-free products. Some formaldehyde-free mineral wool batts are also available.</p>





PRODUCT CATEGORY	Baseline	OPTIONAL	RECOMMENDATIONS
Composite wood	Formaldehyde emissions less than or equal to the thresholds provided by CARB Phase 2 and/or TSCA Title IV for plywood, particleboard, MDF, and these materials within other products like cabinets and doors. For any other composite wood products not covered by CARB/TSCA requirements, but used in interior spaces, these must at minimum be NAUF (have no added urea formaldehyde).	Use of composite woods that are certified ultra-low emitting formaldehyde (ULEF).  1 point per product. <i>[2 points maximum]</i>	While finish products (including plywood, MDF, particleboard, and cabinet and door components) comply by law with this Baseline requirement, ensure that all products installed in the project that are exposed to the conditioned space meet these standards or at a minimum do not include added urea formaldehyde.  No-added formaldehyde (NAF) products qualify as ULEF and will be eligible for optional points. However, be aware that the alternative binders utilized in these products may include regrettable substitutions. For instance, the most common alternative binder for composite wood is PMDI, which is made with isocyanates. PMDI is expected to be a lower hazard during use than formaldehyde, but more information is needed. Preferable alternatives would be more than half bio-based (e.g., binders that are at least 50% soy) with full content disclosure, so they can be vetted for health hazards.

## RECOMMENDATIONS

All products, and product labels, are not equal. Be aware that when selecting products in order to avoid a given characteristic, there is a chance of selecting an alternate product with an equally poor chemical inventory that has not yet been characterized or assessed—leading to a regrettable substitution. To minimize the likelihood of this, consider avoiding products that contain certain classes of chemicals rather than specific (studied) chemicals. Definitions of chemicals that fall into the chemical classes outlined above can be found in Pharos. See below to links for specific chemical classes.

- Alkylphenol ethoxylates (APEs): [www.pharosproject.net/material/show/2089943](http://www.pharosproject.net/material/show/2089943)
- Phthalates: [www.pharosproject.net/material/show/2072101](http://www.pharosproject.net/material/show/2072101)
- Per- and polyfluoroalkyl substances (PFASs): [www.pharosproject.net/material/show/2072164](http://www.pharosproject.net/material/show/2072164)
- Halogenated flame retardants (HFRs): [www.pharosproject.net/material/show/2072163](http://www.pharosproject.net/material/show/2072163)

For all material installation, be sure to closely follow the manufacturer's instructions. Many products require increased ventilation during installation and curing and should be applied/installed only when wearing appropriate safety gear, including, but not limited to, eye protection, respirators, gloves, and skin protection. If residents are in place while potentially hazardous materials are being used, take extra precautions. Residents should be moved out of the building during the product application and for the duration of the curing period noted by the manufacturer.



## RESOURCES

- See Appendix L, SCAQMD Tables for Use With Criterion 6.4.

### *Product Selection Resources*

- Green Wise Gold products have been tested and certified to pass the indoor air quality requirements of the California 01350 Small Chamber Emissions Test, and to contain less than 5 grams VOC per liter, even after tinting with specified colorants. Green Wise Gold certified products meet the same performance and durability standards as the original Green Wise certified products. [www.greenwisepaint.com/green-wise-gold](http://www.greenwisepaint.com/green-wise-gold)
- Master Painters Institute, Extreme Green paint standard approved products list. [www.paintinfo.com/MPInews/ExtremeGreen\\_Jan2010.shtml](http://www.paintinfo.com/MPInews/ExtremeGreen_Jan2010.shtml)
- Indoor airPLUS guidance on finding low emissions materials. [www.epa.gov/sites/production/files/2015-10/documents/how\\_to\\_find\\_compliant\\_low\\_emission\\_products\\_508.pdf](http://www.epa.gov/sites/production/files/2015-10/documents/how_to_find_compliant_low_emission_products_508.pdf)
- The Red List and the Watch List contain the worst-in-class materials prevalent in the building industry. [living-future.org/declare/declare-about/red-list/](http://living-future.org/declare/declare-about/red-list/)
- The SCS FloorScore program website includes information about the program, as well as a list of certified products that is updated regularly. [www.scs-certified.com/iaq/floorscore.html](http://www.scs-certified.com/iaq/floorscore.html) and [www.rfci.com](http://www.rfci.com)
- GREENGUARD Gold certification. [spot.ul.com/main-app/products/catalog/](http://spot.ul.com/main-app/products/catalog/)
- The Carpet and Rug Institute maintains a list of manufacturers and products meeting the Green Label Plus standard. [www.carpet-rug.org/CRI-Testing-Programs/Green-Label-Plus.aspx](http://www.carpet-rug.org/CRI-Testing-Programs/Green-Label-Plus.aspx)
- HomeFree. The Healthy Building Network's national initiative supporting affordable housing leaders who are improving human health by using less toxic building materials. Provides healthy building material recommendations and education. [homefree.healthybuilding.net/](http://homefree.healthybuilding.net/)
- Product Guides. BuildingGreen's independent team of editors has compiled guides to more than 100 product categories to help you learn what to look for when selecting green products that avoid negative health impacts. [www.buildinggreen.com/product-guidance](http://www.buildinggreen.com/product-guidance)
- The Master Painters Institute, Green Performance Standard for Paints & Coatings GPS-2-08 list of products. [paintinfo.com/mpi/approved/Partner\\_index.shtml](http://paintinfo.com/mpi/approved/Partner_index.shtml)
- Green Seal. Provides information on environmentally preferable products and services. [www.greenseal.org/Home.aspx](http://www.greenseal.org/Home.aspx)
- Scientific Certification Systems (SCS): Offers an SCS Indoor Air Advantage + Formaldehyde Free Certification for composite wood products. [www.scs-certified.com/products/index.php](http://www.scs-certified.com/products/index.php)
- Energy Efficiency for All, Making Affordable Multifamily Housing More Energy Efficient: A Guide to Healthier Upgrade Materials. For those who decide what products to use that ranks insulation and air-sealing products from a health standpoint and includes recommendations to move up the ladder. [www.energyefficiencyforall.org/resources/making-affordable-multifamily-housing-more-energy-efficient-guide-healthier-upgrade/](http://www.energyefficiencyforall.org/resources/making-affordable-multifamily-housing-more-energy-efficient-guide-healthier-upgrade/)
- Building Clean, an initiative of the BlueGreen Alliance Foundation, has various resources created for the affordable housing community. The Certified Products Database is a consolidated database of more than 15,000 building products. Search for products with any combination of chemical hazard optimization, low-VOC certifications and/or ingredient disclosures, including Red List-free, C2C, LBC Compliant, FloorScore, GREENGUARD, Green Label Plus, Indoor Advantage, Green Seal, Living Product Certification, HPD, Product Lens and Declare. [buildingclean.org/building/products/flooring](http://buildingclean.org/building/products/flooring)



---

## Guidance Resources

- Pharos provides open access to a wealth of information to support chemical hazard assessment, alternatives assessment, and informed substitution. This includes hazard data for more than 140,000 chemicals; data on chemical function, use, and exposure; and a forum for discussions about critical hazard assessment issues. It also contains profiles of common content and associated hazards for many types of building products, through Common Product profiles. Pharos is developed and managed by the Healthy Building Network. [www.pharosproject.net](http://www.pharosproject.net)
- Six Classes, a project of the Green Science Policy Institute that frames a Six Classes approach to reducing chemical harm. [www.sixclasses.org](http://www.sixclasses.org)
- SCAQMD, Rules 1113 and 1168 limiting VOC content. [www.aqmd.gov/home/regulations/rules](http://www.aqmd.gov/home/regulations/rules)
- U.S. Environmental Protection Agency, Frequent Questions for Consumers about the Formaldehyde Standards for Composite Wood Products Act. [www.epa.gov/sites/production/files/2019-01/documents/frequent\\_questions\\_for\\_consumers\\_about\\_the\\_formaldehyde\\_standards\\_for\\_composite\\_wood\\_products\\_act\\_0.pdf](http://www.epa.gov/sites/production/files/2019-01/documents/frequent_questions_for_consumers_about_the_formaldehyde_standards_for_composite_wood_products_act_0.pdf)
- The California EPA Air Resources Board, FAQ on Composite Wood Products. [www.arb.ca.gov/toxics/compwood/consumer\\_faq.pdf](http://www.arb.ca.gov/toxics/compwood/consumer_faq.pdf)
- U.S. Environmental Protection Agency identified phthalates, a chemical used to make sheet vinyl pliable, as a “chemical of concern” on December 30, 2009. [www.epa.gov/assessing-and-managing-chemicals-under-tsca/phthalates](http://www.epa.gov/assessing-and-managing-chemicals-under-tsca/phthalates)
- Healthy Building Network, Full Disclosure Required: A Strategy to Prevent Asthma through Building Product Selection. A report identifying asthmagens that are included as contents in building materials and making recommendations for product improvement.



## 6.5

### **OPTIONAL** *12 POINTS MAXIMUM*

# ENVIRONMENTALLY RESPONSIBLE MATERIAL SELECTION

## **RATIONALE**

Product selection has environmental implications, both in production and throughout operations. Just as with toxicity of building material content, transparency regarding embodied greenhouse gas emissions of materials is a critical first step in identifying optimum product selection. The embodied carbon associated with the products that are specified for a building determine that building's climate impact before anyone turns on a light. While the overall climate impact of a property will be determined by the sum of its embodied emissions and operations emissions, a high-performance building (with low emissions due to operations) built from materials with high embodied energy will release more total emissions than a code-compliant building (from an operating energy perspective) built with materials with moderate embodied emissions. A first step in determining the embodied emissions of building materials is to evaluate the Global Warming Potential of each product through an Environmental Product Disclosure (EPD). Note that many building materials with low embodied emissions also have lower human health hazards.

In addition to evaluating embodied emissions of a project's materials, the characteristics of timber and the reduction of urban heat islands can be impacted through material specification:

Less than 10% of the old growth forest remains in the United States. The use of salvaged wood and engineered wood products throughout your building for major structural components reduces the need to use old-growth lumber. Forest Stewardship Council certified wood encourages forestry practices that are environmentally responsible, including protecting plant and animal species, the rights of indigenous people, and forest worker safety, and preserving valuable and free ecosystem services such as recreation and filtering water and air. Intact and sustainably managed forests and soils also store the excess greenhouse gases that cause climate change.

Urban heat islands increase local air temperatures due to the absorption of solar energy by the built environment. Reducing the heat-island effect through thoughtful roofing and paving product selection decreases energy consumption by decreasing loads on cooling systems, and it enhances resilience by reducing overheating of buildings in the event of power outages when air conditioning cannot operate.



PRODUCT CATEGORY	OPTIONAL	RECOMMENDATIONS
Concrete, steel, insulation	<p>Submit a publicly disclosed EPD for 90% by volume for all (concrete/steel/insulation) used in the project. Clearly indicate the total Global Warming Potential (GWP).</p> <p>1 point available for compliance with each of the three materials (concrete, steel, insulation). Only new products should be counted; existing/reused/salvaged products are exempt.</p>	<p>Compare the GWP of your specified concrete product to the industry average for your region (see NRMCA resource below).</p> <p>EPDs from different sources should not be used comparatively, as there are likely different assumptions underlying their creation.</p> <p>Consider prioritizing products with low Global Warming Potential for those materials that make up the larger volumes of the building.</p>
Roofing	<p>Install a combination of the following to cover at least 90% of the roofing area:</p> <ul style="list-style-type: none"> <li>· A “green” (vegetated) roof</li> <li>· For roofs with slopes less than or equal to 2:12, roofing materials that have an SRI of at least 0.65 (initial) or at least 0.50 (3-year aged)</li> <li>· For roofs with slopes greater than 2:12, install roofing materials that have an SRI of at least 0.25 (initial) or at least 0.15 (3-year aged).</li> </ul> <p><i>[3 points]</i></p>	<p>EPA will sunset its labeling of ENERGY STAR roof products by June 1, 2022, as many states and municipalities have adopted codes that include standards for roof products on commercial buildings that are stricter than the ENERGY STAR Roof Products Version 3 specification in the climate zones where reflective roofs are most beneficial (Zones 1–3). Properties are instead encouraged to implement guidance from EPA’s Heat Island Reduction Program.</p> <p>PVC roofing membranes include phthalates. Consider using thermoplastic polyolefin (TPO) based roofing instead.</p>
Paving	<p>Use light-colored, high-albedo materials with an initial minimum solar reflectance of 0.33 and/or an open-grid pavement system over at least 50% of the site’s hardscaped area.</p> <p><i>[3 points]</i></p>	<p>If a roof space is designed and installed in such a way that intends regular resident access and use, that space would be considered a hardscaped area and subject to the paving requirement.</p> <p>Consider using paving materials that both reduce urban heat-island effect and that are water permeable.</p>
Wood, non-composite	<p>Use FSC certified wood or salvaged wood for at least 50% by cost for all structural, framing, sheathing, decking, subfloor, and finish applications.</p> <p><i>[3 points]</i></p>	



## RESOURCES

- Environmental Product Declaration (EPD). An EPD is an independently verified and registered document that communicates transparent and comparable information about the life cycle environmental impact of products. As a voluntary declaration of the life cycle environmental impact, having an EPD for a product does not imply that the declared product is environmentally superior to alternatives. [www.environdec.com/What-is-an-EPD/](http://www.environdec.com/What-is-an-EPD/)
- Roadmap to Reducing Building Life Cycle Impacts. This timeline, part of the Practice Guide linked below, contains suggested milestones and actions for reducing building life cycle impacts. [carbonleadershipforum.org/wp-content/uploads/2019/05/2019.05.23-LCA-Timeline-Diagram-2-page.pdf](http://carbonleadershipforum.org/wp-content/uploads/2019/05/2019.05.23-LCA-Timeline-Diagram-2-page.pdf)
- The Embodied Carbon Network™ is a collective group of individuals within focus groups committed to designing embodied and operational carbon out of new and renovated buildings to achieve a carbon-neutral built environment by 2050. [embodiedcarbonnetwork.org/](http://embodiedcarbonnetwork.org/)
- Life-cycle assessment (LCA). Practice Guide provides guidance on how to conduct an LCA of a building and provides key resources. [www.carbonleadershipforum.org/lca-practice-guide/](http://www.carbonleadershipforum.org/lca-practice-guide/)
- Carbon Smart Materials Palette. A project of Architecture 2030, this Palette is an attribute-based design and material specification guide. [materialspalette.org/about/](http://materialspalette.org/about/)
- National Ready Mixed Concrete Association (NRMCA) sustainability resources, which include industry benchmarks for Global Warming Potential of products with varying strengths for different applications and exposure conditions. Use these regional benchmarks to compare the GWP of your specified concrete product to the industry average for your region. [www.nrmca.org/sustainability/EPDProgram/Index.asp#IndustryBaselines](http://www.nrmca.org/sustainability/EPDProgram/Index.asp#IndustryBaselines)
- Athena Institute. A nonprofit, Athena's development of its LCA design tools, the Impact Estimator for Buildings and Pavement LCA, may be used free of charge by design teams to evaluate the relative climate impacts of material selections in their properties. [www.athenasmi.org/our-software-data/overview/](http://www.athenasmi.org/our-software-data/overview/)
- Tally. A Revit® software plug-in that calculates environmental impact of building materials for whole building analysis as well as comparative analysis of design options. [choosetally.com/](http://choosetally.com/)
- U.S. Environmental Protection Agency, Heat Island Effect. This site contains information about heat-island effect, its social and environmental costs, and strategies to minimize its prevalence, including shading, cool roofs, green roofs, and coloration of hardscapes. [www.epa.gov/heatislands](http://www.epa.gov/heatislands)
- Cool Roof Rating Council (CRRC), Directory of Rated Products. CRRC maintains a third-party rating system of radiative properties of roof surfacing materials. [coolroofs.org/products/results](http://coolroofs.org/products/results)
- Lawrence Berkeley National Laboratory, Heat Island Group. The Lawrence Berkeley National Laboratory conducts research to find, analyze and implement solutions to minimizing heat-island effects; its current efforts focus on the study and development of more-reflective surfaces for roadways and buildings. [heatisland.lbl.gov/](http://heatisland.lbl.gov/)
- Building Materials Reuse Association. [bmra.org/](http://bmra.org/)



## 6.6

### BASELINE

**BASELINE FOR NEW CONSTRUCTION AND SUBSTANTIAL REHAB. MODERATE REHABS THAT DO NOT INCLUDE WORK IN THE SHOWER AND TUB AREAS ARE EXEMPT FROM THE SHOWER AND TUB ENCLOSURE REQUIREMENT.**

## BATH, KITCHEN, LAUNDRY SURFACES

### RATIONALE

The use of durable, cleanable, moisture-resistant materials in wet areas reduces the potential for damage due to moisture and the potential for indoor mold growth that may yield odors and pose health hazards to residents and staff. These materials and proper moisture detailing reduce long-term maintenance costs as well.

### REQUIREMENTS

Use materials that have durable, cleanable surfaces throughout bathrooms, kitchens, and laundry rooms. Materials installed in these rooms should not be prone to deterioration due to moisture intrusion or encourage the growth of mold.

Use moisture-resistant backing materials such as cement board, fiber cement board, or equivalent per ASTM #D 6329 or ASTM #D 3273 behind tub/shower enclosures. Projects using a one-piece fiberglass tub/shower enclosure are exempt from this requirement.

### RECOMMENDATIONS

When possible, avoid using materials such as unsealed grout, which traps and holds moisture and can facilitate mold growth.

### RESOURCES

- Product Guides. BuildingGreen's independent team of editors has compiled guides to more than 100 product categories to help you learn what to look for when selecting green products that avoid negative health impacts. [www.buildinggreen.com/product-guidance](http://www.buildinggreen.com/product-guidance)
- Method Analysis of Microbial-Resistant Gypsum Products. [cfpub.epa.gov/si/si\\_public\\_record\\_report.cfm?dirEntryId=309637&Lab=NRMRL\)%20maybe%20we%20should%20switch%20reference%20to%20ASTM%20D6329?](http://cfpub.epa.gov/si/si_public_record_report.cfm?dirEntryId=309637&Lab=NRMRL)%20maybe%20we%20should%20switch%20reference%20to%20ASTM%20D6329?)



## 6.7

### OPTIONAL

4 POINTS MAXIMUM

### BASELINE

IOWA GREEN STREETS CERTIFICATION PLUS

## REGIONAL MATERIALS

### RATIONALE

Building materials that are extracted, processed, and manufactured locally to the project site minimize the energy embedded in their transportation and contribute to the local economy. Use of local materials can also reflect local identity, history, or context, increasing sense of connection to place.

### REQUIREMENTS

Use products that were extracted, processed and manufactured regionally for a minimum of 90%, based on weight or on cost, of the amount of the product category installed in the project. Identify in project application to IEDA and project construction specifications the regional products being used and where the product was processed and manufactured.

Building product categories that can qualify for these points include the following (every two compliant products can qualify for 1 point):

- Framing materials
- Exterior materials (e.g., siding, masonry, roofing)
- Flooring materials
- Concrete/cement and aggregate material
- Drywall/interior sheathing materials

Note: Mechanical, electrical, and plumbing components cannot be included in this calculation.

### RECOMMENDATIONS

Natural building materials that are approved by HUD or USDA can qualify for points under this measure.

### RESOURCES

- Building Green, Product Guides. BuildingGreen's independent team of editors has compiled guides to more than 100 product categories to help you learn what to look for when selecting green products that avoid negative health impacts. [www.buildinggreen.com/product-guidance](http://www.buildinggreen.com/product-guidance)
- Building Clean has various resources created for the affordable housing community. The American-Made Products Database is a database of building products manufactured throughout the United States. Search for products manufactured near your project site with its Search by ZIP Code Tool: [buildingclean.org/building/zipcode-search](http://buildingclean.org/building/zipcode-search). The more than 4,500 American manufacturing sites within the database can also be searched by CSI code and/or product material. American-Made Products Database: [buildingclean.org/building/advanced-search](http://buildingclean.org/building/advanced-search)





## 6.8

### **BASELINE**

**FOR ALL NEW CONSTRUCTION PROJECTS AND ALL REHAB PROJECTS IMPACTING CONCRETE SLABS OR CRAWL SPACES**

## MANAGING MOISTURE: FOUNDATIONS

### **RATIONALE**

Moisture can move through building structures in four ways: as bulk water, through capillary action, through air transport, and through vapor diffusion. The dominant type of moisture movement control sought in a given scenario will dictate the type of materials that should be installed, and how those materials should be installed, to either allow or suppress that moisture movement.

Ideally, a property will be designed and constructed with four continuous control layers, listed here in priority in order: 1) continuous water control layer via a weather resistant barrier that includes flashing and sealed penetrations that manages bulk and capillary moisture movement away from the structure, 2) continuous air control layer enclosing the conditioned space, 3) continuous vapor control layer, 4) continuous thermal control layer (insulation).

Specifying these four continuous control layers is simple upon first glance, but, depending on the property's climate zone, assembly type, and site, complex hygrothermal configuration issues arise very quickly that require careful detailing and material specification. As buildings are constructed that perform well in terms of energy efficiency, the burden to carefully detail moisture control strategies increases.

Consider your property's foundation. Moisture can migrate through concrete and most other masonry materials. Proper installation of foundation drainage, vapor retarders, and waterproofing materials can greatly reduce the migration of moisture that can occur even in non-saturated soils. While installation of the four continuous control layers in accordance with the unique hygrothermal needs of a property should always be front of mind, the basic prescriptive strategies below will solve for egregious moisture movement across the foundation assembly.

### **REQUIREMENTS**

#### ***Beneath Concrete Slabs***

***(including those in basements and crawl spaces; Rehabs are exempt)***

- Install a capillary break as follows: 4-inch layer of ½-inch diameter or greater clean aggregate  
OR Install a 4-inch uniform layer of sand, overlain with a layer or strips of geotextile drainage matting installed according to the manufacturer's instructions
- Install at least 1" (R-5) extruded 25 lb high-density polystyrene below the entire slab (2" (R-10) of foamunder at least the outer four feet of the slab perimeter) in addition to the vapor barrier to control mold growth
- Immediately below the slab, install at least 10-mil polyethylene sheeting overlapped at least 6 inches at the seams to serve as a vapor barrier in direct contact with the slab above.



- Place a capillary break on top of footings between the footing and foundation wall to stop capillary action.
- On interior below-grade walls, do not use a vapor barrier over air-permeable insulation. Do not install a below-grade vertical insulation (such as polyethylene sheeting, vinyl wallpaper, vinyl(plastic)-faced blankets, or foil faced), which can trap moisture inside wall systems. Semi-vapor permeable rigid insulation is not considered a vapor barrier.

### ***Beneath Crawl Spaces without Slabs***

#### ***(projects on raised pier foundations with no foundation walls are exempt)***

- Install at least 10-mil cross-laminated polyethylene on the crawl floor, extended up at least 12 inches on piers and foundation walls, and with joints overlapping at least 12 inches. The 10-mil and the cross-lamination ensure longevity of the poly.

## **RECOMMENDATIONS**

- Where a high water table is anticipated or observed or has been documented in the soil boring report, or where specifically recommended by the geotechnical engineer, provide subsurface drain tile or other drainage system in strict accordance with the geotechnical engineer's or other qualified professional's recommendations to divert underground water away from the structure.
- Ensure that subsequent trades' work does not puncture the vapor retarder.

## **RESOURCES**

- U.S. Environmental Protection Agency. Indoor airPLUS construction specifications. [www.epa.gov/indoorairplus/indoor-airplus-program-documents](http://www.epa.gov/indoorairplus/indoor-airplus-program-documents)
- U.S. Department of Energy, Office of Energy Efficiency & Renewable Energy, Building America. Free downloads on best building practices. [www.energy.gov/eere/buildings/building-america](http://www.energy.gov/eere/buildings/building-america)
- Advanced Energy. Comprehensive best practice crawl space design and installation guidelines. [www.advancedenergy.org/portal/crawl\\_spaces/](http://www.advancedenergy.org/portal/crawl_spaces/)
- Building Science Corporation. Features articles on conditioned crawl spaces. [www.buildingscience.com/resources/cond-crawlspaces](http://www.buildingscience.com/resources/cond-crawlspaces)
- Building Science Corporation. Guidance regarding design and installation of below-grade walls. Crawlspace: [www.buildingscience.com/documents/information-sheets/crawlspace-insulation](http://www.buildingscience.com/documents/information-sheets/crawlspace-insulation) and Basements: [www.buildingscience.com/documents/building-science-insights/bsi-110-keeping-water-out-basements](http://www.buildingscience.com/documents/building-science-insights/bsi-110-keeping-water-out-basements)
- The Partnership for Advanced Technology in Housing. This site has an extensive, searchable resource section with pertinent information about construction solutions. [www.huduser.gov/portal/consumer/home.html](http://www.huduser.gov/portal/consumer/home.html)

## 6.9

### BASELINE

**FOR ALL NEW CONSTRUCTION AND REHAB PROJECTS THAT INCLUDE DEFICIENCIES IN OR INCLUDE REPLACING PARTICULAR ASSEMBLIES CALLED OUT BELOW.**

## MANAGING MOISTURE: ROOFING AND WALL SYSTEMS

### RATIONALE

Moisture can move through building structures in four ways: as bulk water, through capillary action, through air transport, and through vapor diffusion. The dominant type of moisture movement control sought in a given scenario will dictate the type of materials that should be installed, and how those materials should be installed, to either allow or suppress that moisture movement.

Ideally, a property will be designed and constructed with four continuous control layers, listed here in priority in order: 1) continuous water control layer via a weather resistant barrier that includes flashing and sealed penetrations that manages bulk and capillary moisture movement away from the structure, 2) continuous air control layer enclosing the conditioned space, 3) continuous vapor control layer, 4) continuous thermal control layer (insulation).

Specifying these four continuous control layers is simple upon first glance, but depending on the property's climate zone, assembly type, and site, complex hygrothermal configuration issues arise very quickly that require careful detailing and material specification. As buildings are constructed that perform well in terms of energy efficiency, the burden to carefully detail moisture control strategies increases.

Consider your property's wall systems. Diverting water from the project prevents bulk water entry into wall systems, which can contribute to moisture-related problems such as mold and the deterioration of and other building materials. Properly installed weather barriers, including flashing and drainage planes, help direct water away from wall cavities. While installation of the four continuous control layers in accordance with the unique hygrothermal needs of a property should always be front of mind, the basic prescriptive strategies below will solve for egregious moisture movement across the foundation assembly.

### REQUIREMENTS

Provide water drainage away from walls, windows, and roofs by implementing the following techniques:

#### ***Water Management: Wall Systems***

- Provide a continuous housewrap/weather-resistive barrier with sheets lapped shingle-style to prevent bulk water that penetrates the finished exterior cladding system from entering the wall assembly or being introduced through window or door openings or through other penetrations. Alternatively, install a fluid applied weather-resistive barrier in accordance with manufacturer's instructions. Taped systems such as Zip, Force Field, and others are acceptable.
- Vapor control assembly of wall system designed in accordance with IRC R702.7 and installed per manufacturer instructions. Where continuous insulation is installed with R-values  $\geq 5$  for a 2x4 wall, or  $\geq 7.5$  for a 2x6 wall in CZ5 install a smart vapor retarder on the warm in winter side.

- Flashings at roof/wall intersections and wall penetrations (i.e., plumbing, electrical, vents, HVAC refrigerant lines and the like in addition to windows and doors) must be integrated with the weather-resistant barrier and drainage plane prior to any exterior finish being installed to prevent bulk water from entering the exterior wall assembly. This includes kick-out flashing where a sloped roof eave terminates in a wall with siding, stucco, or other applied finish apart from brick veneer.
- Flashing installed at bottom of exterior walls with weep holes included for masonry veneer and weep screed for stucco cladding systems or equivalent drainage system.

### Water Management: Roof Systems

- Install drip edge at entire perimeter of roof.
- At wall/roof intersections, maintain  $\geq 2$ " clearance (or others recommended by manufacturer) between wall cladding and roofing materials, install flashing along the intersection, and use kick-out flashing as noted above.

## RECOMMENDATIONS

- Install a “perfect” wall. [www.buildingscience.com/documents/insights/bsi-001-the-perfect-wall](http://www.buildingscience.com/documents/insights/bsi-001-the-perfect-wall) and [buildingscienceeducation.net/wp-content/uploads/2017/06/Control-Layer-definitions-glossary.pdf](http://buildingscienceeducation.net/wp-content/uploads/2017/06/Control-Layer-definitions-glossary.pdf)

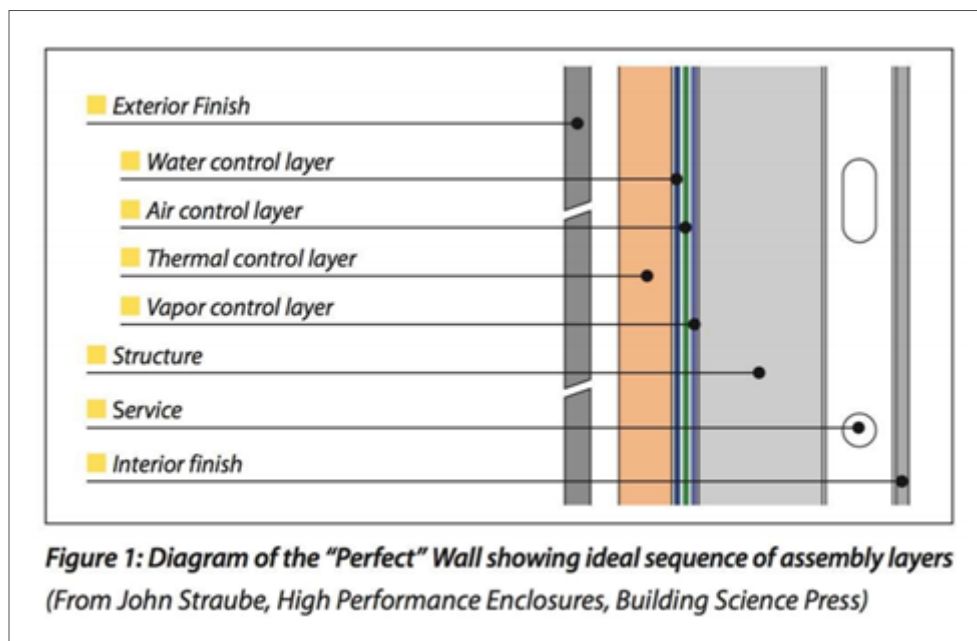

- Many of the strategies required through this criterion are also required by code. The importance of proper installation of these materials is critical and will impact the building throughout its time in service.
- Ensure that a vapor retarder with an appropriate permeability rating is installed on the correct side of the wall assembly, based on climate considerations and drying potential. Acoustical sealant, rather than tape, is recommended to seal vapor retarder to framing.



---

## RESOURCES

- U.S. Department of Energy, Building Technologies Office. Free downloads on best building practices. [www.energy.gov/eere/buildings/building-technologies-office](http://www.energy.gov/eere/buildings/building-technologies-office)
- U.S. Environmental Protection Agency, Indoor airPLUS Construction Specifications. Includes detailed construction specifications, several of which are focused on moisture management. [www.epa.gov/indoorairplus/indoor-airplus-program-documents](http://www.epa.gov/indoorairplus/indoor-airplus-program-documents)
- The Energy & Environmental Building Alliance, Water Management Guide. Excellent installation details for weather-resistive barriers and flashing. [www.energy.gov/sites/prod/files/2014/01/f6/3\\_1b\\_ba\\_innov\\_eeba\\_watermgmtguide\\_011713.pdf](http://www.energy.gov/sites/prod/files/2014/01/f6/3_1b_ba_innov_eeba_watermgmtguide_011713.pdf)



# 6.10

## **BASELINE AND OPTIONAL 6 POINTS MAXIMUM CONSTRUCTION WASTE MANAGEMENT**

### **RATIONALE**

Diverting construction debris, and recycling and reusing materials whenever possible, reduces waste and disposal costs. In addition, construction waste management reduces the project's impact on landfills.

### **REQUIREMENTS**

Develop and implement a waste management plan that reduces non-hazardous construction and demolition waste through recycling, salvaging, or diversion strategies; maintain documentation on diversion rate for each selected strategy.

**Baseline:** All projects must select either one pathway in Option 1 (a or b), two pathways in Option 2 (c – j), or one pathway in Option 3 (k or l). No points are accrued for compliance with this Baseline requirement.

**Optional:** Projects may select additional pathways to accrue optional points. These pathways may be from within a different Option from what the project chose to comply with as Baseline. Not to exceed 6 optional points.

#### ***Option 1: Measured by Percentage***

- a. Provide a waste plan that diverts 75% of the construction waste from the landfill [1 point]
- b. Provide a waste plan that diverts 95% of the construction waste from the landfill [1 point]

#### ***Option 2: Material Specific***

- c. Recycle all cardboard [1 point]
- d. Recycle all wood [1 point]
- e. Recycle all drywall [1 point]
- f. Recycle all metals. [1 point]
- g. Recycle all concrete, brick, and asphalt [1 point]
- h. Recycle all insulation, foam, and plastics [1 point]
- i. Recycle all carpet [1 point]
- j. Develop and implement a comprehensive efficient framing plan that minimizes all waste by design [1 point]

#### ***Option 3: Minimizing Construction Waste—New Construction Only***

- k. Total construction waste to landfill or incinerator <2.5 lbs /SF of building [2 points]
- l. Total construction waste to landfill or incinerator <1.5 lbs /SF of building [3 points]



## RECOMMENDATIONS

- Create detailed framing plans or scopes of work and accompanying architectural details for use on the job site to proactively reduce waste. Create a detailed cut list and lumber order prior to construction.
- Consider creating a feedback loop on waste generation from the site to the person responsible for material purchasing and/or paying disposal costs. The feedback loop could be as simple as a photo record of the dumpster after each major stage of construction, shared back with the materials purchaser and/or whom tracks waste disposal costs. Use this information to hone purchasing and minimize materials waste.
- Avoid disposal of materials by instead donating them to nonprofit organizations or through manufacturer take-back programs.
- On-site separation of materials should be practiced to the greatest extent feasible as this ensures a higher quality product for recycling (e.g., gypsum wallboard).
- In the project documentation (construction specification Division 1 Section 01 74 19), identify the construction waste management expectations for the project.
- Investigate and document local options for recycling or reusing all anticipated major constituents of the project waste stream, including cardboard packaging and “household” recyclables (e.g., beverage containers).
- For projects with limited access to recycling centers, consider waste diversion strategies such as using panelized walls and roof trusses to minimize total materials.
- Consider recycling carpet for rehab projects when carpeting is being removed. The specification language below may be customized and included to determine whether carpet recycling is feasible and cost-effective in your locale.
  - Vendor shall supply a price quote to recycle carpet and carpet components at 100%, 50%, and 30% of product tonnage.
  - Property manager shall identify the carpet product and polymer, nylon, polypropylene (which is documented on carpet specification). This will enable the carpet vendor to ascertain the recyclability of the product.
- Some manufacturers of drywall and certain types of ceiling tiles will accept the return of old materials for re-processing.

## RESOURCES

- Iowa Waste Exchange. A free technical assistance provider with knowledge of recycling markets. [www.iowadnr.gov/environmental-protection/land-quality/waste-planning-recycling/iowa-waste-exchange-iwe](http://www.iowadnr.gov/environmental-protection/land-quality/waste-planning-recycling/iowa-waste-exchange-iwe)
- Waste Management and Recovery, A Field Guide for Residential Remodelers. [p2infohouse.org/ref/45/44120.pdf](http://p2infohouse.org/ref/45/44120.pdf)
- NAHB Research Center, Best Practices for Construction Waste Management. This site includes frequently asked questions, case studies, reports, and various links. It includes A Builder’s Field Guide, which includes guidance for creating a step-by-step construction waste management and recovery plan. [www.wbdg.org/resources/construction-waste-management](http://www.wbdg.org/resources/construction-waste-management)
- U.S. Environmental Protection Agency, WasteWise Program. This site has information about the WasteWise Building Challenge program, including articles, publications, and various links and resources for more information. [www.epa.gov/smm/wastewise](http://www.epa.gov/smm/wastewise)



- 
- U.S. Environmental Protection Agency, Construction and Demolition Debris. Includes basic information on construction and demolition debris disposal practices, regional and state programs, publications, and links.  
[www.epa.gov/smm/sustainable-management-construction-and-demolition-materials](http://www.epa.gov/smm/sustainable-management-construction-and-demolition-materials)
  - Construction & Demolition Recycling Association. This site includes links to websites on recycling concrete, asphalt roof shingles and drywall, as well as a state-by-state listing of construction waste reusers and recyclers. [www.cdrecycling.org](http://www.cdrecycling.org)





# 6.11

## OPTIONAL 2 POINTS

# RECYCLING STORAGE

### RATIONALE

Recycling prevents usable materials from entering the waste stream. Providing bins within the living space or office for the separation of recyclables from trash encourages higher rates of recycling.

### REQUIREMENTS

For projects in locations with municipal recycling infrastructure and/or recycling haulers, provide separate bins for the collection of trash and recycling for each dwelling unit, office and all shared meeting/community rooms and have recyclables collected.

For projects in locations without municipal recycling infrastructure or recycling haulers, advocate to the local waste hauler or municipality for regular collection of recyclables. Commit to providing recycling bins if service becomes available.

### RECOMMENDATIONS

- Ensure that the recycling program has management support and include your procedures in the project maintenance manual (Criterion 8.1) and Occupant Manual (Criterion 8.3).
- Ensure that signage and bin colors are consistent across the project, and with local community norms where applicable. Consider the opportunity for functional artwork through creative/artistic recycling containers. [www.thesteelyard.org/publicprojects/aboutpp](http://www.thesteelyard.org/publicprojects/aboutpp)
- Designate an area for recyclable collection and storage that is appropriately sized and located in a convenient area.
- Consider adding an additional paper recycling bin in a location where residents/tenants routinely check their mail.
- Identify local haulers and recyclers for glass, plastic, metals, office paper, newspaper, cardboard, and organic wastes. This may include artists or public art organizations seeking to divert solid waste by creating art using recycled materials.
- In multifamily, commercial and nonprofit buildings, instruct occupants on recycling procedures through clear and visible signs that include pictures and that are translated into a variety of languages spoken by occupants and visitors.



---

## RESOURCES

- Enterprise Green Communities Resource Center. Enterprise Green Communities hosts a variety of resident engagement tools and trainings, including a module on waste reduction and recycling. Search for “Resident Engagement” at this link: [www.enterprisecommunity.com/resources](http://www.enterprisecommunity.com/resources)
- NYC Department of Sanitation, What to Recycle with Sanitation. This site maintains a host of good background information on recycling basics. Contact your city/county about local recycling policies and procedures. [www1.nyc.gov/assets/dsny/site/services/recycling/what-to-recycle](http://www1.nyc.gov/assets/dsny/site/services/recycling/what-to-recycle)
- The City of Saint Paul's Mears Park combines recycling and public art to increase quality of life and expand recycling opportunities. [www.stpaul.gov/news/recycling-and-art-meet-mears-park](http://www.stpaul.gov/news/recycling-and-art-meet-mears-park)
- NYC's Zero Waste Design Guidelines offer recommendations for designers on reducing waste. [www.zerowastedesign.org/](http://www.zerowastedesign.org/)

“This building has  
become a family.”

Resident of Enterprise Green  
Communities property

INTRODUCTION CRITERIA CHECKLIST

- 1 INTEGRATIVE DESIGN
- 2 LOCATION + NEIGHBORHOOD FABRIC
- 3 SITE IMPROVEMENT
- 4 WATER
- 5 OPERATING ENERGY
- 6 MATERIALS
- 7 HEALTHY LIVING ENVIRONMENT**
- 8 OPERATIONS, MAINTENANCE + OCCUPANT ENGAGEMENT

APPENDIX

## HEALTHY LIVING ENVIRONMENT

DESIGN, CONSTRUCTION, AND OPERATIONS STRATEGIES MAY CONTRIBUTE TO A HEALTHIER ENVIRONMENT BY REDUCING EXPOSURE TO TOXINS, MANAGING THE INDOOR ENVIRONMENT, AND PROMOTING HEALTH THROUGH DESIGN.



## I. REDUCING EXPOSURE TO ENVIRONMENTAL HAZARDS (Criteria 7.1 – 7.6)

# 7.1

## BASELINE FOR NEW CONSTRUCTION AND SUBSTANTIAL REHAB RADON MITIGATION

### RATIONALE

Radon is a radioactive gas generated by the natural decay of uranium in the soil and rock below and around buildings. It can enter homes through holes and cracks. Breathing radon gas increases the risk of lung cancer. Radon is the leading environmental cause of cancer mortality in the United States.

Exposure to radon is the second leading cause of lung cancer in the U.S., after smoking. A smoker who is also exposed to radon has a much higher risk of lung cancer. The only way to know if homes have elevated radon levels is to test. Testing is easy and inexpensive, and elevated radon levels can be reliably mitigated, if necessary, with simple, durable, and commonly available materials and techniques.

### REQUIREMENTS

#### *New Construction*

In EPA Zone 1 areas (all of Iowa), install passive radon-resistant features below the slab. Also install a vertical vent pipe with junction box within 10 feet of an electrical outlet in case an active system should prove necessary in the future. If the radon level is above the EPA action level of 4 pCi/L (pico curies per liter) convert system from passive to active and activate system.

Exception: Buildings with garages attached to a foundation system do not require soil gas vent systems if compliant with ANSI/ASHRAE 62.1, Sections 5.15 and 6.5 for ventilation and pressurization of enclosed spaces surrounding the garage.

#### *Substantial Rehab*

Test Substantial Rehab projects located in EPA Zone 1 areas under the supervision of a radon professional for the presence of radon in accordance with ANSI-AARST MAMF-2017 for multifamily buildings or ANSI-AARST MAH-2014 for single-family homes. In time-sensitive situations, consistent with HUD's radon policy, a radon professional may sample a minimum of 25% of randomly selected ground-level dwelling units.

If the radon level is above the EPA action level of 4 pCi/L (pico curies per liter), install radon-reduction measures per ANSI-AARSTR RMS-MF 2018 for multifamily buildings or SGM-SF-2017 for homes.

After all rehab work is complete, test again. For post-test levels between 4 and 10 pCi/L, consider a long-term test (minimum 90 days) to confirm an increase before undertaking the mitigation process. Then, if radon levels after renovation are  $\geq 4$  pCi/L install mitigation in accordance with ANSI-AARST RMS-MF 2018 for multifamily or, for homes, either ANSI-AARST SGM-SF-2017 or ASTM 2121.

A radon professional shall have:

- Certification from either the American Association of Radon Scientists and Technologists' (AARST) National Radon Proficiency Program (NRPP) or the National Radon Safety Board (NRSB), and
- Certification/license from the state in which the testing or mitigation work is being conducted, if the state has this requirement.

## RECOMMENDATIONS

- For new construction properties, refer to these standards for construction guidelines. ANSI-AARST Standard: Reducing Radon in New Construction: 1 & 2 Family Dwellings and Townhouses, CCAH-2013, and ANSI-AARST Standard: Soil Gas Control Systems in New Construction, CC-1000-2018, for larger buildings.
- Iowa Department of Public Health. <https://idph.iowa.gov/radon>
- Short-term tests offer an affordable screening method for many homes. Longer-term testing may provide a more accurate representation of the annual exposure to radon and the need for mitigation. If short-term results are between 2 and 10 picocuries per liter (pCi/L), consider conducting a long-term radon test (minimum 90 days).
- A radon vent fan should be installed when the test result is 4 pCi/L or more. EPA recommends that all homes built with radon-resistant features in EPA Radon Zone 1 pre-emptively include a radon vent fan.
- Guidance for underground garages:
  - International Mechanical Code (IMC), which requires 0.75 cfm/sf for garages serving multifamily projects, and ASHRAE Standard 62.1-2010 section 5.15, which encourages maintaining attached garage air pressure at or below adjacent occupiable spaces.
  - If the pressure management strategy is not designed to continually maintain negative pressure in the underground garage space relative to the occupied spaces (i.e., if a timer is used for exhaust fan control), then radon control is not assured. In such situations, use either the radon-resistant New Construction techniques summarized in Interactive Planning (IAP) spec 2.1 ([www.epa.gov/sites/production/files/2018-03/documents/indoor\\_airplus\\_construction\\_specifications.pdf](http://www.epa.gov/sites/production/files/2018-03/documents/indoor_airplus_construction_specifications.pdf)) and detailed further in EPA guidance and /or test the occupied space for radon.
  - If the underground garage does not cover the entire foundation (i.e., some living space is directly above a slab or crawlspace), then those portions of the project should be handled per Indoor airPLUS specs.
  - Any mechanical or service closets in the garage area that are connected to the conditioned enclosure should be aggressively sealed between the garage and the conditioned space.
- Preemptive radon-reduction measures include installing airtight drain fittings (e.g., trap or flange system) in the floor drains of the foundation; sealing and caulking penetrations, openings or cracks in below-grade walls and floors that contact the ground with a sealant that meets the requirements of ASTM C920; covering exposed earthen floors in basements and crawlspaces according to Section 1.2 of EPA's Indoor airPLUS Construction Specifications; air-sealing sumps by installing an airtight sump cover in such a way that water can drain from above (e.g., with a ball valve) and below the sump cover.

## RESOURCES

- U.S. Environmental Protection Agency: [www.epa.gov/radon/epa-map-radon-zones](http://www.epa.gov/radon/epa-map-radon-zones).
- Contact your state radon coordinator through the state health office to determine if your project is located in a Zone 1 radon area: [idph.iowa.gov/radon](http://idph.iowa.gov/radon)
- American Lung Association, Radon Fact Sheet. This is a general overview of the health risks associated with radon exposure. [www.lung.org/clean-air/at-home/indoor-air-pollutants/radon](http://www.lung.org/clean-air/at-home/indoor-air-pollutants/radon)
- Washington State, Extension Energy Program, Builder's Field Guide. Chapter 2 of this field guide provides tips, procedures and schematics for understanding how to mitigate radon risks during new construction. [www.energy.wsu.edu/Documents/Builders\\_Field\\_Guide-2006.pdf](http://www.energy.wsu.edu/Documents/Builders_Field_Guide-2006.pdf)
- National Center for Healthy Housing, Radon-Resistant Construction: Low-Rise Multi-Family Housing. [nchh.org/resource-library/Factsheet\\_Radon--no%20HDF.pdf](http://nchh.org/resource-library/Factsheet_Radon--no%20HDF.pdf)
- U.S. Environmental Protection Agency, Building Radon Out. 2006 (#EPA/402-K-01-002). [nepis.epa.gov/Exe/ZyPURL.cgi?Dockey=000002ZT.txt](http://nepis.epa.gov/Exe/ZyPURL.cgi?Dockey=000002ZT.txt)
- ANSI-AARST standards. [aarst-nrpp.com/wp/store/](http://aarst-nrpp.com/wp/store/)
  - Building design: CCAH-2013 for homes and CC-1000-2018 for larger buildings
  - Measuring radon: MAH-2014 for homes and MAMF for multifamily buildings
  - Mitigating radon in existing buildings: RMS-MF-2018 for multifamily buildings and SGM-SF-2017 for homes
- ASTM E2121-13 Standard Practice for Installing Radon Mitigation Systems in Existing Low-Rise Residential Buildings. [www.astm.org/Standards/E2121.htm](http://www.astm.org/Standards/E2121.htm)

## 7.2

### BASELINE

#### *SUBSTANTIAL REHAB ON BUILDINGS CONSTRUCTED BEFORE 1978*

## REDUCE LEAD HAZARDS IN PRE-1978 BUILDINGS

### RATIONALE

Lead from paint is one of the most common causes of lead poisoning. Exposure to lead dust, lead in soil and deteriorated lead-based paint poses significant risks to young children (<6 years) and pregnant women, affecting long-term neurological development, IQ, and learning issues. In rare cases, extreme lead exposure can result in death. In homes built before 1978, the year the federal government banned consumer uses of lead-based paint, risk of exposure still exists. Opportunities exist to control those lead hazards in buildings as part of renovation projects.

### REQUIREMENTS

Conduct lead risk assessment or inspection to identify lead hazards. Control identified lead hazards using lead abatement or interim controls, using lead-safe work practices that minimize and contain dust. Follow EPA or state and/or local laws and requirements, where applicable. Alternatively, follow standard lead treatments defined by HUD as a series of hazard reduction measures designed to reduce all lead-based paint hazards in a dwelling unit without the benefit of a risk assessment or other evaluation (25 CFR 34.110).

Check state or local regulations for additional requirements for lead-safe work pertaining to prohibited practices, notification, worker training and certification and clearance dust training.

### RECOMMENDATIONS

- A lead inspection should be undertaken by an EPA certified risk assessor to determine whether paint in a rehab project contains lead, otherwise paint should be presumed to contain lead and lead-safe work practices are required.
- Perform dust lead clearance testing at the conclusion of renovation work; compare against EPA dust lead clearance standards.
- Remove or cover lead-contaminated soil so that it is inaccessible to children. For gardening, use raised beds with lead-free soil.

### RESOURCES

- Find information from the EPA about lead abatement, inspection, and risk assessment, as well as find accredited firms. [www.epa.gov/lead/lead-abatement-inspection-and-risk-assessment](http://www.epa.gov/lead/lead-abatement-inspection-and-risk-assessment)
- U.S. Environmental Protection Agency's RRP Rule. [www.epa.gov/lead/lead-renovation-repair-and-painting-program](http://www.epa.gov/lead/lead-renovation-repair-and-painting-program)
- U.S. Department of Housing and Urban Development. Find information from about lead-safe work practices. [www.hud.gov/program\\_offices/healthy\\_homes](http://www.hud.gov/program_offices/healthy_homes)
- U.S. Department of Housing and Urban Development, American Healthy Housing Survey. [portal.hud.gov/hudportal/documents/huddoc?id=AHHS\\_REPORT.pdf](http://portal.hud.gov/hudportal/documents/huddoc?id=AHHS_REPORT.pdf)

## 7.3

# BASELINE COMBUSTION EQUIPMENT

### RATIONALE

Direct-vent appliances bring outdoor air through a sealed pipe and help exhaust combustion products directly outdoors through another hard-piped vent. No indoor air is used, so there is very little risk of spillage or back-drafting. Power-vented appliances rely on indoor air but use a fan to push exhaust products through the flue to the outside. These are much less susceptible to spillage and back-drafting than conventional units.

### REQUIREMENTS

For new construction and rehab projects, specify power-vented or direct-vent equipment when installing any new combustion appliance for space or water heating that will be located within the conditioned space.

If there are any combustion appliances in the conditioned space, install one hard-wired carbon monoxide (CO) alarm with battery backup function for each sleeping zone, placed per National Fire Protection Association (NFPA) 72.

In Substantial and Moderate Rehabs, if there is any combustion equipment located within the conditioned space for space or water heating that is not power-vented or direct-vent and that is not scheduled for replacement, conduct combustion safety testing prior to and after the retrofit. Conduct the combustion safety testing for central systems and for 10% of these individual dwelling unit systems per RESNET Guidelines for Combustion Safety and Developing Work Orders or BPI Combustion Safety Test Procedures for Vented Appliances. Report any deficiencies immediately to the owner or owner's representative in any failed tested system.

This criterion does not apply to projects without any combustion equipment (i.e., space and water heating equipment, cook tops, dryers, or any other combustion equipment) nor to projects with combustion equipment located only in detached utility buildings or open-air facilities.

### RECOMMENDATIONS

CO and smoke detectors may be hard wired to the heating and domestic hot water system (DHW) system, thus activating if that equipment malfunctions.

### RESOURCES

- U.S. Environmental Protection Agency, Combustion Products and Carbon Monoxide. These two extensive EPA sites describe the sources of carbon monoxide and other combustion gases, their health effects, steps to reduce exposure, and related standards and guidelines, and provide additional resources and links. [www.epa.gov/indoor-air-quality-iaq/sources-combustion-products-introduction-indoor-air-quality](http://www.epa.gov/indoor-air-quality-iaq/sources-combustion-products-introduction-indoor-air-quality) and [www.epa.gov/iaq/co.html](http://www.epa.gov/iaq/co.html)



- NFPA 72 contains requirements for the performance, installation, operation, inspection, testing and maintenance of CO detection and warning equipment. These requirements address installations of commercial systems and components as well as installations of single- and multiple- station CO alarms and household CO detection systems.  
[www.nfpa.org/codes-and-standards/all-codes-and-standards/list-of-codes-and-standards/detail?code=72](http://www.nfpa.org/codes-and-standards/all-codes-and-standards/list-of-codes-and-standards/detail?code=72)
- Underwriters Laboratories, Product Safety Tips: CO Alarms. This site provides a basic overview of the problems associated with carbon monoxide, as well as tips about purchasing and installing carbon monoxide alarms.  
[code-authorities.ul.com/about/blog/carbon-monoxide-alarm-considerations-for-code-authorities/](http://code-authorities.ul.com/about/blog/carbon-monoxide-alarm-considerations-for-code-authorities/)
- U.S. Consumer Product Safety Commission, Carbon Monoxide Questions and Answers.  
[www.cpsc.gov/Safety-Education/Safety-Education-Centers/Carbon-Monoxide-Information-Center/Carbon-Monoxide-Questions-and-Answers](http://www.cpsc.gov/Safety-Education/Safety-Education-Centers/Carbon-Monoxide-Information-Center/Carbon-Monoxide-Questions-and-Answers)
- Building Performance Institute, Combustion Safety Procedures.  
[bpi.org/sites/default/files/COMBUSTION%20APPLIANCE%20SAFETY%20INSPECTION%20FOR%20VENTED%20APPLIANCES.pdf](http://bpi.org/sites/default/files/COMBUSTION%20APPLIANCE%20SAFETY%20INSPECTION%20FOR%20VENTED%20APPLIANCES.pdf)  
and for all BPI standards: [www.bpi.org/tools\\_downloads.aspx?selectedTypeID=1&selectedID=2](http://www.bpi.org/tools_downloads.aspx?selectedTypeID=1&selectedID=2)
- Environmental Health Perspectives, Take Care in the Kitchen: Avoiding Cooking-Related Pollutants, Nate Seltenrich: [ehp.niehs.nih.gov/122-a154/](http://ehp.niehs.nih.gov/122-a154/) or Environmental Health Perspectives 122:A154– A159: [dx.doi.org/10.1289/ehp.122-A154](https://dx.doi.org/10.1289/ehp.122-A154)

## 7.4

# BASELINE GARAGE ISOLATION

### RATIONALE

Carbon monoxide (CO) inhalation can be dangerous to human health. The air barrier and air sealing will help prevent carbon monoxide migration from the garage to the living space, and the CO alarm will help ensure that residents are alerted in the case of accidental accumulation of the gas.

### REQUIREMENTS

- Provide a continuous air barrier between the conditioned space and any garage space to prevent the migration of contaminants into the living space. Visually inspect common walls and ceilings between attached garages and living spaces to ensure that they are air-sealed before insulation is installed.
- Do not install ductwork or air handling equipment for the conditioned space in a garage.
- Fix all connecting doors between conditioned space and garage with gaskets, or otherwise make substantially airtight with weather stripping.
- Install one hard-wired carbon monoxide (CO) alarm with battery backup function for each sleeping zone of the project, placed per NFPA 72, unless the garage is mechanically ventilated or an open parking structure as defined by code.

### RECOMMENDATIONS

Refer to ASHRAE 62.1 for garage contaminant isolation measures.

### RESOURCES

- National Institute of Standards and Technology, Air and Pollutant Transport from Attached Garages to Residential Living Spaces. This report provides an overview of the major issues, as well as a review of relevant scientific studies and a series of field studies.  
[www.nist.gov/publications/air-and-pollutant-transport-attached-garages-residential-living-spaces-literature](http://www.nist.gov/publications/air-and-pollutant-transport-attached-garages-residential-living-spaces-literature)
- The Energy & Environmental Building Alliance. Builder's Guide to Cold Climates, Joseph Lstiburek, Ph.D., P.Eng. Building Science Press. Refer to the discussion and construction details regarding air sealing and connected garages.  
[www.buildingscience.com/bookstore/books/builders-guide-cold-climates](http://www.buildingscience.com/bookstore/books/builders-guide-cold-climates)
- U.S. Environmental Protection Agency, Indoor airPLUS Construction Specifications.  
[www.epa.gov/sites/production/files/2018-03/documents/indoor\\_airplus\\_construction\\_specifications.pdf](http://www.epa.gov/sites/production/files/2018-03/documents/indoor_airplus_construction_specifications.pdf)

## 7.5

# BASELINE INTEGRATED PEST MANAGEMENT

### RATIONALE

Integrated pest management (IPM) is an approach to manage pest damage by the most economical means, and with the least possible hazard to people, property, and the environment. While pest damage can be, and is often, controlled through application of pesticides, IPM is a more holistic approach with applications in building design, construction, and operations. Incorporating pest prevention in the design of new buildings and in retrofits increases the durability of the building and, in the end, saves time and money by proactively taking steps to prevent conditions that attract pests. Sealing of cracks and penetrations will minimize entry points for pests such as rodents and cockroaches. Exposure to allergens from pests is linked with asthma and respiratory issues. Rodents may also carry diseases.

Avoiding unnecessary pesticides, improving resident housekeeping, and promptly responding to pest problems and conditions that contribute to pests will reduce the chemicals needed to treat pests and will keep homes pest-free longer than solely relying on a routine chemical treatment program.

### REQUIREMENTS

Design for easy inspection of all pest-prone areas (interior and exterior), and engineer slabs and foundations to minimize pest entry.

Seal all wall, floor and joint penetrations with low-VOC caulking or other appropriate nontoxic sealing methods (window screens, door sweeps, escutcheon plates, elastomeric sealants) to prevent pest entry. Use rodent- and corrosion-proof screens (e.g., copper or stainless-steel mesh or rigid-metal cloth) for openings greater than ¼-inch. Also pay close attention to sealing off entry points under kitchen and bathroom sinks.

### RECOMMENDATIONS

- Refer to Maintenance and Occupant Manuals (Criteria 8.1 and 8.3) for complementary practices.
- Plan exterior surfaces, lighting, drainage, and landscaping to minimize the attractiveness of the site to pests.
- Preventive pest management work should be completed in conjunction with air sealing. Project teams should work with an air sealing contractor and a pest management professional to ensure that IPM strategies are part of the scope.
- Hire a pest management professional (PMP) with experience in integrated pest management to work with the general contractor and trades and to combine pest prevention activities into the contractor scopes of work.
- Rehabilitation of an existing building provides the opportunity to address physical barriers that make handling garbage difficult. Engage with building occupants and maintenance staff to identify and correct problems with the collection and storage of waste (e.g., inadequate space in trash rooms, narrow stairs, improper signage, unsafe access to exterior trash receptacles). Also, before the rehab, consider engaging with a pest management professional to inspect the building, review occupant feedback, and provide a report on pest conditions and corrective recommendations.

- Consider hiring a PMP with experience in integrated pest management to work with the contractor and combine pest prevention activities as part of the contractor's scope of services. PMP qualifications to consider include GreenShield or QualityPro certified; association membership with a national or state pest management association; PMP certification: Associate Certified Entomologist (ACE) or Board-Certified Entomologist (BCE).

## RESOURCES

- San Francisco Department of the Environment, Pest Prevention by Design: Authoritative Guidelines for Building Pests Out of Structures.  
[www.sfenvironment.org/download/pest-prevention-by-design-guidelines](http://www.sfenvironment.org/download/pest-prevention-by-design-guidelines)
- NYC Department of Health and Mental Hygiene, Pest Control for Building Owners, Managers, Supers, and Workers.  
[www1.nyc.gov/site/doh/health/health-topics/pests-and-pesticides-building-owners.page](http://www1.nyc.gov/site/doh/health/health-topics/pests-and-pesticides-building-owners.page)
- The National Center for Healthy Housing, Integrated Pest Management Interventions for Healthier Homes Case Study Series.  
[nchh.org/who-we-are/nchh-publications/case-studies/ipm-interventions-for-hh-case-studies/](http://nchh.org/who-we-are/nchh-publications/case-studies/ipm-interventions-for-hh-case-studies/)
- City of Seattle, Seattle Public Utilities. The City of Seattle maintains many helpful resources concerning sustainable, natural care of plants and lawns, including information on integrated pest management strategies and helpful factsheets.  
[www.seattle.gov/utilities/businesses-and-key-accounts/landscapes/integrated-pest-management](http://www.seattle.gov/utilities/businesses-and-key-accounts/landscapes/integrated-pest-management)
- Integrated Pest Management, A Guide for Affordable Housing. [www.stoppests.org/Guide](http://www.stoppests.org/Guide)
- NYC Department of Health and Mental Hygiene, Healthy Homes Program. Pest Prevention Opportunities During Renovation Work Factsheet.  
[www1.nyc.gov/assets/doh/downloads/pdf/pesticide/mgmt-opportunities.pdf](http://www1.nyc.gov/assets/doh/downloads/pdf/pesticide/mgmt-opportunities.pdf)



## II. MANAGING THE INDOOR ENVIRONMENT (Criteria 7.7 – 7.11)

# 7.6

## BASELINE AND OPTIONAL 10 POINTS SMOKE-FREE POLICY

### RATIONALE

Secondhand smoke is the third leading cause of preventable death in this country, is a common asthma trigger, and is associated with coronary artery disease. Air filtration and ventilation systems do not eliminate the health hazards caused by secondhand smoke. Smoke from one unit may seep through the cracks, be circulated by a shared ventilation system or otherwise enter the living space of another. There is no safe level of exposure to secondhand smoke. In addition to the negative health effects, smoking significantly increases fire hazards and increases cleaning and maintenance costs.

### REQUIREMENTS

#### *Baseline for all properties*

Implement and enforce a smoke-free policy in all common areas and within a 25-foot perimeter around the exterior of all projects, or up to the property line if the parcel does not allow for a 25-foot distance. Lease language must prohibit smoking in these locations and provide a graduated enforcement policy. Smoking should be considered a minor lease violation. The smoke-free policy applies to all owners, tenants, guests, and service people. The use of e-cigarettes is prohibited wherever smoking is prohibited.

Include the smoke-free policy, harms of smoking, and how the policy will be enforced, in readily available materials for occupants, staff, and visitors.

#### *Optional [10 points]*

Expand the policy above to include all indoor spaces in the property.

### RECOMMENDATIONS

- Ensure that staff are trained on the policy so that it is enforced in a consistent manner and that staff (not tenants) are solely responsible for policy enforcement.
- Eviction should only be a last resort in response to a smoke-free violation, and a graduated enforcement policy emphasizes communication to residents about the policy and its impacts. Through graduated enforcement, you may reset the enforcement steps after a set time period without another violation, include a reasonable accommodation policy, and include steps such as:
  - First offense: verbal warning and reminder of property's smoke-free policy
  - Second offense: written warning
  - Third offense: more serious warning paired with requirements for resident to demonstrate that they are moving toward compliance
  - Fourth offense: strenuous warning, cleaning fee comparable to costs required for unit turn, and more strenuous requirements for resident to demonstrate that they are moving toward compliance

- If implementing a no-smoking policy in an occupied building, plan on a 12-18 month resident engagement effort and a pre-quit campaign. Excellent resources exist—see Resources below.
- If working with a new or an unoccupied building, all building marketing materials should clearly state the smoke-free policy. Project owners and managers should inform residents that they are prohibited from smoking in or around the property. This information should be incorporated into the Occupant Manual as well as manuals for building management and maintenance staff (see Criteria 8.1 and 8.3).
- Effectively communicate the rationale for implementing the no-smoking policy to residents, with particular attention to and education around the harms of second- and third-hand smoking.
- Provide resources and education around smoking cessation. See Resources for more information.
- Consider including a designated, lit, outdoor smoking area as an alternative arrangement for those who smoke or vape. Design this area to be as attractive as possible, provide shelter from the elements, and be accessible for users with various forms of mobility in order to encourage smokers to smoke in this location rather than inside the building or within the 25-foot-perimeter no-smoking buffer area.
- Provide suitable receptacles in the designated outdoor smoking area for the disposal of cigarette butt litter. Ensure that the receptacles are inside the project line and do not encroach into public space.

## RESOURCES

- Iowa Smokefree Air Act. [smokefreeair.iowa.gov/](http://smokefreeair.iowa.gov/)
- U.S. Department of Housing and Urban Development, Smoke Free Housing: A Toolkit for Owners/ Management Agents of Federally Assisted Public and Multi-Family Housing. [www.hud.gov/sites/documents/PDFOWNERS.PDF](http://www.hud.gov/sites/documents/PDFOWNERS.PDF)
- American Lung Association, Air Quality in the Home. This site includes an entire section devoted to indoor air quality in the home. Choose “Air Quality” at the bottom of the screen and then click “Indoor Air Quality” and “Air Quality in the Home” to find numerous articles and educational pieces about maintaining a healthy indoor environment. [www.lungusa.org](http://www.lungusa.org)
- Clean Air for All, The Smoke-Free Public Housing Project. [smokefreepublichousingproject.org/resource-bank.php](http://smokefreepublichousingproject.org/resource-bank.php)
- Global Directory of Smoke-Free Housing Programs. [mnsSmokeFreeHousing.org/smoke-free-housing-directory/](http://mnsSmokeFreeHousing.org/smoke-free-housing-directory/)
- American Lung Association Tobacco Cessation Coverage. Medicare: [www.lung.org/assets/documents/tobacco/tobacco-cessation-coverage-in.pdf](http://www.lung.org/assets/documents/tobacco/tobacco-cessation-coverage-in.pdf) and for the Uninsured: [www.lung.org/assets/documents/tobacco/cessation-resources-available.pdf](http://www.lung.org/assets/documents/tobacco/cessation-resources-available.pdf)
- Southeastern PA Tobacco Control Project, Smoke Free Multi-Unit Housing Enforcement Guide. [www.sepatobaccofree.org/sites/default/files/muhenforcementguide\\_10\\_3\\_18.pdf](http://www.sepatobaccofree.org/sites/default/files/muhenforcementguide_10_3_18.pdf)
- New York Landlord Smoke-Free Housing Toolkit. [www.tobaccopolicycenter.org/documents/SFHNY%20Landlord%20Toolkit%20-%20Oct%202014.pdf](http://www.tobaccopolicycenter.org/documents/SFHNY%20Landlord%20Toolkit%20-%20Oct%202014.pdf)
- U.S. Department of Housing and Urban Development, Implementing HUD’s Smoke-Free Policy in Public Housing: HUD Guidebook. [www.hud.gov/sites/documents/SMOKEFREE\\_GUIDEBK.PDF](http://www.hud.gov/sites/documents/SMOKEFREE_GUIDEBK.PDF)
- U.S. Environmental Protection Agency, Indoor Air Quality Division. This site has numerous resources related to indoor air quality in homes, including reports and web links. [www.epa.gov/indoor-air-quality-iaq](http://www.epa.gov/indoor-air-quality-iaq)



- 
- U.S. Department of Housing and Urban Development, Smoke-Free Housing Tool Kit. [www.hud.gov/sites/documents/PDFOWNERS.PDF](http://www.hud.gov/sites/documents/PDFOWNERS.PDF)
  - Capital District Tobacco-Free Coalition. [www.smokefreecapital.org](http://www.smokefreecapital.org)
  - NYC Department of Health's Smoke-Free Housing Resources. [www1.nyc.gov/site/doh/health/health-topics/smoking-smoke-free-housing.page](http://www1.nyc.gov/site/doh/health/health-topics/smoking-smoke-free-housing.page)
  - Michigan Smoke-Free Apartments. [www.mismokefreeapartment.org/listing.html](http://www.mismokefreeapartment.org/listing.html)
  - Smoke-Free Housing Coalition of Maine. [breatheeasymaine.org/](http://breatheeasymaine.org/)
  - Minnesota Smoke-Free Housing. [www.mnsmokefreehousing.org](http://www.mnsmokefreehousing.org)
  - Smoke-Free Environments Law Project. [www.tcsg.org/sfelp/home.htm](http://www.tcsg.org/sfelp/home.htm)
  - Tobacco Technical Assistance Consortium. [www.ttac.org](http://www.ttac.org)
  - LISC webinar, Going Smoke Free: Best Practices of Multifamily Housing Owners & Managers. [www.lisc.org/our-resources/resource/lisc-experts-online-going-smoke-free-best-practices-multifamily-housing-owners-managers](http://www.lisc.org/our-resources/resource/lisc-experts-online-going-smoke-free-best-practices-multifamily-housing-owners-managers)
  - Smoking Cessation Leadership Center. [smokingcessationleadership.ucsf.edu/campaigns/smoke-free-public-housing-helping-smokers-quit](http://smokingcessationleadership.ucsf.edu/campaigns/smoke-free-public-housing-helping-smokers-quit)
  - Live Smoke Free. [www.mnsmokefreehousing.org/](http://www.mnsmokefreehousing.org/)

# 7.7

## BASELINE NEW CONSTRUCTION AND SUBSTANTIAL REHAB OPTIONAL MODERATE REHAB | 12 POINTS MAXIMUM VENTILATION

### RATIONALE

Optimal ventilation improves indoor air quality, contributing to a healthier living environment.

Properly sized and controlled exhaust fans in bathrooms and kitchens remove moisture-laden air, lowering the potential for indoor mold growth that may yield odors, pose health hazards to occupants, and create durability concerns. Kitchen fans also help remove carbon dioxide and carbon monoxide over fuel-burning appliances and other air contaminants that may be byproducts of cooking. ENERGY STAR-qualified bathroom fans use 65% less energy on average than standard models and move more air per unit of energy used with less noise. Timers and humidistat sensors help to ensure that fans regularly remove moisture and provide adequate ventilation.

### REQUIREMENTS

#### RESIDENTIAL PROJECTS

For each dwelling unit, in full accordance with ASHRAE 62.2-2010, install:

- A local mechanical exhaust system in each bathroom [3 points if Moderate Rehab]
- A local mechanical exhaust system in each kitchen [3 points if Moderate Rehab]
- A whole-house mechanical ventilation system [3 points if Moderate Rehab]

Verify and ensure that these dwelling unit ventilation system flow rates are either within +/- 15 CFM or +/- 15% of design value.

#### Note:

1. Local exhaust airflow may be credited toward the whole-house ventilation airflow requirement when local exhaust fans are used to provide whole-house mechanical ventilation.
2. For Substantial and Moderate Rehab projects, particularly those of a historic or landmark nature, consult the current adopted edition of the International Energy Conservation Code for the state of Iowa for compliance options for ventilation in existing buildings.
3. Projects that achieve certification with Passive House Institute United States (PHIUS+) are permitted to follow the Passive House ventilation requirements as an alternative to meeting the Criterion 7.7 ventilation requirements as they relate to kitchens, so long as there are no combustion fueled appliances within the dwelling unit and at minimum there is a continuous kitchen exhaust rate of 25 CFM per 2009 IRC Table M1507.3.

Also, for each **multifamily building of four stories or more**, in full accordance with ASHRAE 62.1-2010, install a mechanical ventilation system for all hallways and common spaces *[3 points if Moderate Rehab]*



### **All Residential Project Types**

- All systems and associated ductwork must be installed per manufacturer's recommendations.
- All individual bathroom fans must be ENERGY STAR-labeled. If not running continuously, these must either be wired to turn on with the light switch or equipped with a humidistat sensor, timer or other control (e.g., occupancy sensor, delay off switch, ventilation controller) to ensure adequate run-time.
- If using central ventilation systems with rooftop fans, each rooftop fan must be direct-drive and variable-speed with speed controller mounted near the fan. Fans with design CFM 300-2000 must also have an ECM motor.

### **NON-RESIDENTIAL PROJECTS**

Comply in full accordance with ASHRAE 62.1 as coordinated with the current adopted edition of the IECC for the State of Iowa.

### **RECOMMENDATIONS**

- For climate-specific strategies, consult ASHRAE 62.2-2010 and the Resources below.
- Install MERV 13 or high rated filters for outdoor air ventilation equipment, particularly in geographic locations where the outdoor air exceeds the national standards for particulate matter (PM2.5, PM10) or ozone, and/or within 500 feet of busy streets and highways.
- Avoid exhaust-only ventilation strategies in Climate Zones 1-4A, to limit uncontrolled intake of humid air.
- Avoid exceeding ventilation requirements, particularly when using local exhaust. Excessive exhaust may depressurize dwelling units, potentially back-drafting combustion appliances.
- Proper installation of each ventilation system is as critical as its design to its performance. Consult the Resources below for best-practice installation techniques. Also consider testing exhaust fan performance as soon as power is available: Hold two squares of toilet paper to the exhaust fan. If, when on, the fan can hold these squares, as a rule of thumb you may assume that the fan is pulling 50 CFM. If the fan is not able to hold the squares of toilet paper, examine the fan's installation.
- Placing a single multi-port, in-line fan in each dwelling unit to exhaust air from the kitchen and bathroom(s) is an acceptable ventilation strategy. If utilizing this strategy, in addition to meeting local code requirements for the minimum distance of thru-wall exhaust vents from windows, ensure that the placement of the exhaust grill meets code requirements for kitchen ventilation.
- With continuous, demand-controlled or other centralized ventilation systems, the project team (specifically, the designer, installer, and maintenance staff) should ensure that the systems are balanced from unit to unit to meet the requirements of ASHRAE 62.2-2010. Also, consider installing fans with ECM motors for fans designed to exhaust more than 250 CFM.
- Consider the following mechanical controls for introducing outside air:
  - Flow control/butterfly damper to regulate the amount of air introduced through an outside air intake.
  - Shut-off damper (electronic or barometric) to close an outside air intake when the HVAC system is not calling for air.
  - Fan timer/cycler on the HVAC system to regulate the length of time an outside air intake remains open.

---

## RESOURCES

- ASHRAE Standard 62.2-2010. This site provides a viewable version of ASHRAE Standard 62.2-2010. [www.ashrae.org/technology/page/548](http://www.ashrae.org/technology/page/548)
- Residential Building Systems, Ventilate Right: Ventilation Guide for New and Existing California Homes. This site provides a thorough, user-friendly guide to installing ventilation systems in accordance with ASHRAE 62.2 as well as best practices in ventilation system design and installation. Equally applicable to projects outside the state of California. [homes.lbl.gov/ventilate-right](http://homes.lbl.gov/ventilate-right)
- Building America Solution Center. This searchable database includes pictorial guides for best practices in ventilation system design and installation. [basc.pnnl.gov/resource-guides](http://basc.pnnl.gov/resource-guides)
- Building Science Corporation, Review of Residential Ventilation Technologies. This report reviews current and potential ventilation technologies for residential projects, with particular emphasis on North American climates and construction. [www.buildingscience.com/documents/reports](http://www.buildingscience.com/documents/reports)
- National Weatherization Assistance Program Impact Evaluation, Impact of Exhaust-Only Ventilation on Radon and Indoor Humidity: A Field Investigation. [weatherization.ornl.gov/wp-content/uploads/pdf/WAPRetroEvalFinalReports/ORNL\\_TM-2014\\_367.pdf](http://weatherization.ornl.gov/wp-content/uploads/pdf/WAPRetroEvalFinalReports/ORNL_TM-2014_367.pdf)
- ENERGY STAR. This website describes the advantages of ENERGY STAR-labeled ventilation fans and provides product and manufacturer lists. [www.energystar.gov/index.cfm?c=vent\\_fans.pr\\_vent\\_fans](http://www.energystar.gov/index.cfm?c=vent_fans.pr_vent_fans)
- Home Ventilating Institute (HVI), Ventilation Systems and Controls. The HVI provides consumers an assurance of product performance. It also works to increase public awareness of the need for good ventilation and provides resources for selecting the proper ventilation products. [www.hvi.org/](http://www.hvi.org/)
- University of Minnesota, Common Questions about Heat and Energy Recovery Ventilators. This site provides a brief, easy-to-understand overview of heat- and energy-recovery ventilators. [www.mnshi.umn.edu/kb/scale/hrverv.html](http://www.mnshi.umn.edu/kb/scale/hrverv.html)

## 7.8

# BASELINE DEHUMIDIFICATION

### RATIONALE

Interior relative humidity levels above 60% are often uncomfortable and can create the conditions for growth of mold, mildew, bacteria, and other biological allergens. The more energy efficient a building, the greater the need to manage its moisture flow. Often, the heating and cooling system cannot sufficiently manage a building's temperature and moisture levels throughout the year—traditional systems are designed to manage temperature only, and they run less frequently in energy efficient homes. Supplemental dehumidification is often needed to manage the property's moisture loads, particularly in cooling-dominated climates.

### REQUIREMENTS

#### *Option 1*

Design, select, and install supplemental dehumidification equipment to keep relative humidity < 60%.

OR

#### *Option 2*

Equip all dwelling units with dedicated space, drain, and electrical hook-ups for permanent supplemental dehumidification systems to be installed if needed. Install interior RH monitoring equipment (e.g., smart thermostats with hygrometers) with alerts and the ability to log humidity levels so that it may be reviewed. For multifamily properties, provide remote access for building operations and maintenance staff to monitor relative humidity and override system controls as necessary.

### RECOMMENDATIONS

- As buildings become more energy efficient and loads decrease, proper sizing and thoughtful approaches to year-round moisture control become more critical in all climate zones.
- For projects located in humid climates, supplemental dehumidification may be necessary to maintain comfort during times of high ambient relative humidity. Design a system with the capacity to meet ASHRAE requirements, and then provide additional accommodations to adjust the outside air introduced as needed. Calculate part load performance of HVAC equipment utilizing ASHRAE Dehumidification 1% Design Days when designing equipment to maintain 60% RH.
- Use ACCA Manual LLH sizing calculations to size your systems to maintain interior RH below 60%; refer to Appendix 3 Ancillary Dehumidification for explicit latent load guidance.
- Do not utilize electric resistance reheat as a strategy for controlling interior moisture as it will lead to high utility bills for those systems.
- Carefully consider interior loads in your HVAC and dehumidification sizing exercises; dense properties may require more dehumidification than initially expected.
- Consider the project's ventilation system. While balanced systems and Energy recovery ventilation (ERV) will not necessarily eliminate the need for stand-alone dehumidification, ventilation strategies that do not exacerbate interior moisture loads are preferred.



---

## RESOURCES

- Building Science Corporation, Measure Guideline: Supplemental Dehumidification in Warm-Humid Climates, by Armin Rudd. [www.nrel.gov/docs/fy15osti/62677.pdf](http://www.nrel.gov/docs/fy15osti/62677.pdf)
- Air Conditioning Contractors of America, Manual LLH: Low Load Homes. [www.acca.org/standards/](http://www.acca.org/standards/)
- Building Green, Ductwork for ERVs: Dehumidifiers, and Forced-Air Heating System, by David Treleven. [www.greenbuildingadvisor.com/article/ductwork-ervs-dehumidifiers-forced-air-heating-systems](http://www.greenbuildingadvisor.com/article/ductwork-ervs-dehumidifiers-forced-air-heating-systems)
- Building Science Corporation, Supplemental Dehumidification in Warm-Humid Climates. [www.buildingscience.com/documents/bareports/ba-1310-supplemental-dehumidification-warm-humid-climates/view](http://www.buildingscience.com/documents/bareports/ba-1310-supplemental-dehumidification-warm-humid-climates/view)
- Building America Solution Center, Whole House Dehumidification. [baso.pnnl.gov/resource-guides/whole-house-dehumidification](http://baso.pnnl.gov/resource-guides/whole-house-dehumidification)
- ASHRAE Journal, Dehumidification and Cooling Loads from Ventilation Air, by Lewis G. Harriman III, Dean Plager, and Douglas Kosar. [energy.mo.gov/sites/energy/files/harriman-dehumidification-and-cooling-loads-from-ventilation-air.pdf](http://energy.mo.gov/sites/energy/files/harriman-dehumidification-and-cooling-loads-from-ventilation-air.pdf)



## 7.9

### **OPTIONAL** *3 POINTS*

# CONSTRUCTION POLLUTION MANAGEMENT

### **RATIONALE**

Left unchecked, particulate matter and air pollution produced by typical construction practices can negatively impact the health and well-being of people working with or living near the construction site.

### **REQUIREMENTS**

#### *Option 1*

Earn the EPA Indoor airPlus label.

OR

#### *Option 2*

Seal all heating, cooling, and ventilation ducts and returns throughout construction to prevent construction debris from entering.

AND

Flush the entire building after completion of construction and prior to occupancy either for at least 48 hours (may be nonconsecutive) with all windows and interior doors open and all HVAC fans running or with at least 14,000 ft<sup>3</sup> per ft<sup>2</sup> of floor area, then replace all air handling equipment filters.

### **RECOMMENDATIONS**

Consider testing building air quality to ensure that desired performance levels are achieved.

# 7.10

## OPTIONAL 3 POINTS

# NOISE REDUCTION

### RATIONALE

Exposure to traffic noise over time poses a risk to adults and is linked to complications with cardiovascular system, diabetes, hypertension, stroke, depression, and high blood pressure. In children, chronic aircraft noise exposure has been shown to impair reading comprehension, mental arithmetic, and proofreading. Continuous noise levels from internally generated noise sources (e.g., HVAC, amenities, appliances, plumbing) have the potential to increase stress, reduce focus, warrant complaints, and decrease occupant's satisfaction with building conditions.

Impact noise and airborne sound transmission between dwelling units has been a leading complaint in multifamily real estate since its inception. With an influx of buildings designed with lightweight construction, impact noise and airborne sound transmission has become common and often results in reduced focus and increased sleep disturbance, annoyance, agitation, and stress. When considered at the onset of project design, multifamily units that apply elements of noise control are more likely to yield comfortable environments for their residents.

### REQUIREMENTS

Manage internally generated noise and exterior noise intrusion within buildings as follows:

#### *Option 1*

Test for and demonstrate that noise levels in rooms such as bedrooms, offices, treatment rooms, etc. meet continuous noise and single sound event limits (30 dB LAeq and 45 dB LAm<sub>ax</sub>, respectively) described in the World Health Organization's Guidelines for Community Noise.

OR

#### *Option 2*

Conduct noise assessment and provide a noise abatement plan specific to the site and covering general noise mitigation techniques in accordance with 24 CFR 51B.

OR

#### *Option 3*

Ensure all exterior wall and party wall penetrations are sealed with acoustical sealant, all party walls and floor/ceiling assemblies have a Sound Transmission Class (STC) rating of at least 55, and exterior windows and doors in projects near a significant exterior noise source have an STC rating of at least 35.

## RECOMMENDATIONS

- Avoid locating bedrooms in areas of the building which face sources of continuous or excessive noise or near mechanical equipment rooms, rooftop mechanical units, generators, plumbing, elevator shafts, amenities, or other source of periodic or continuous operational noise.
- Avoid the use of Packaged Terminal Air Conditioner (PTAC) units in bedrooms, especially when the project site is located within an area of unacceptable noise levels in accordance with HUD (24 CFR 51B).
- Design and install floor-ceiling assemblies as full-span assemblies connected to the walls/partitions and sealed at all flanking paths around all penetrations in accordance with ASTM C919 and sealant manufacturer's recommendations.
- Install or retrofit resilient underlayment, concrete slabs, and/or composite floor-ceiling constructions to meet the minimum code requirements for impact noise insulation, as applicable.
- Consider installing sound reducing barriers.
- Control noise from sources such as HVAC, elevators, amenities, trash chutes, plumbing, electrical components, etc. within dwelling units in accordance with ASHRAE Fundamentals Chapter 48 or ASHRAE 189.1 guidelines.
- For proposed projects located in high noise areas, noise attenuation can be provided as part of HUD (24 CFR 51B). See Chapter 4—Noise Attenuation in HUD resource below for additional information.
- Test building façade elements in accordance with ASTM E90 to meet the minimum level of attenuation needed to provide at least a marginally acceptable level of noise attenuation when provided at the building envelope.
- Include building lease language with description of quiet hours or allowable usage of excessive noise sources (e.g., landscaping, music, events)
- Where building amenities offer high-impact activities like weightlifting, treadmills, running, or similar, provide impact insulation as necessary such that sound from impacts is reduced within dwelling units. (Note: sound from heavy impact noise can travel in all directions throughout the structure of a building, not just from the floor above. It is highly recommended that a professional in acoustics provide recommendations when fitness amenities include high-impact, heavy weightlifting elements).

## RESOURCES

- World Health Organization, Guidelines for Community Noise.  
[apps.who.int/iris/handle/10665/66217](https://apps.who.int/iris/handle/10665/66217)
- U.S. Department of Housing and Urban Development, Noise Abatement and Control. 24 CFS Part51B describes noise standards established by HUD.  
[www.hud.gov/sites/documents/NOISEABATEMENT.PDF](http://www.hud.gov/sites/documents/NOISEABATEMENT.PDF)
- U.S. Environmental Protection Agency, Clean Air Act Title IV—Noise. This site includes sections related to abatement, health effects, regulated noise sources, and other useful education related to noise as a pollutant. [www.epa.gov/clean-air-act-overview/clean-air-act-title-iv-noise-pollution](http://www.epa.gov/clean-air-act-overview/clean-air-act-title-iv-noise-pollution)
- U.S. Department of Housing and Urban Development, Noise Abatement and Control. Includes links to the guidelines, Day/Night Noise Assessment Tool, Sound Transmission Class Assessment Tool, and Barrier Performance Module.  
[www.hudexchange.info/programs/environmental-review/noise-abatement-and-control/](http://www.hudexchange.info/programs/environmental-review/noise-abatement-and-control/)



- 
- 2018 International Green Construction Code powered by Standard ASHRAE 189.1-2017. The updated acoustic control section of ASHRAE 189.1-2017 offers additional guidance on noise control elements for green buildings which are most effectively adhered to during preliminary design stages. [www.ashrae.org/technical-resources/bookstore/standard-189-1](http://www.ashrae.org/technical-resources/bookstore/standard-189-1)
  - ICC G2-2010 Guidelines for Acoustics. These guidelines offer examples, installation, and testing requirements for assessing sound transmission between vertically adjacent spaces. [media.iccsafe.org/store/2015Handbook/ICC\\_G2-2010.pdf](http://media.iccsafe.org/store/2015Handbook/ICC_G2-2010.pdf)
  - IBC 2015 Chapter 12: Interior Environment. Section 1207 details the code minimum requirement for sound transmission and includes a link to view ICC-ES (evaluation service) providers that can provide additional support when installing resilient flooring. [codes.iccsafe.org/content/IBC2015/chapter-12-interior-environment?site\\_type=public](http://codes.iccsafe.org/content/IBC2015/chapter-12-interior-environment?site_type=public)



### III. PROMOTING HEALTH THROUGH DESIGN (Criteria 7.11 – 7.13)

## 7.11

### OPTIONAL 8 POINTS

## ACTIVE DESIGN: PROMOTING PHYSICAL ACTIVITY

### RATIONALE

Physical inactivity increases the risk of many chronic diseases and conditions, including obesity, hypertension, heart disease, stroke, some cancers, and Type 2 diabetes. Two minutes of stair climbing daily burns enough calories to prevent annual average weight gain. Common stairs also encourage social interactions and improve mental health. Climbing 20–34 floors of stairs per week (~3–5 floors per day) is associated with a reduced stroke risk of 29%, and climbing 100–150 floors of stairs per week is associated with a 10%–20% decrease in all-cause mortality.

For those occupants for whom stairway travel may be dangerous due to their limited functional mobility, other key design considerations may positively influence their level of physical activity. In these instances, building or site design measures that increase either frequency or duration of physical activity are encouraged.

Child play and adult exercise reduce the risks of obesity, improve mental health, and encourage social interactions. Improving access to places for physical activity can result in a 25% increase in the number of people who exercise at least three times per week.

### REQUIREMENTS

#### *Option 1: Encouraging Everyday Stair Usage*

**Buildings that include stairs as the only means to travel from one floor to another are not eligible for this option.**

Provide a staircase that is accessible and visible from the main lobby as well as visible and within a 25-foot walking distance from any edge of the lobby. Ensure that no turns or obstacles prevent visibility of or accessibility to the qualifying staircase from the lobby, and that the staircase is encountered before or at the same time as the elevators. Ensure that stairway lighting and finishes are consistent with, or better than, those in the building corridor to encourage use. Place point-of-decision signage at building entrance and corridor intersections to promote stair use (rather than elevator use) for health and other benefits. From the corridor, accessible staircases should be made visible by at least one of the below means:

- Providing transparent glazing of at least 10 sq.ft. (1 square meter) at all stair doors or at a side light
- Providing magnetic door holds on all doors leading to the stairs, as long as allowable by fire code
- Removing door enclosures/vestibules, as long as allowable by fire code

OR

#### *Option 2: Activity Spaces*

Provide an on-site dedicated recreation space with exercise or play opportunities for adults and/or children that is open and accessible to all tenants. The space must be at least 400 square feet, include adult exercise and/or children's play equipment for a minimum of 5% of building occupants, and ensure minimum operational hours for use of 10 hours/day at least 3 days/week. Complementary tenant engagement strategies may promote outdoor play, exercise, gardening, or other physical activity.

## RECOMMENDATIONS

### *Encouraging Everyday Stair Usage*

- Consider active design strategies early on in the project, with tenants, as part of the integrative design process, and determine which features are appropriate based on the expected building population, building characteristics, and potential related programming strategies.
- Stairwell finishes, as well as clear and appealing visuals such as windows or artwork, provide a pleasant experience and encourage stair use for those who are able.
- In high-rise buildings, provide an integrated vertical circulation system that incorporates stair use for travel between adjacent floors, so that elevators are used primarily for vertical travel of four floors or more.
- Consider programming elevators so they do not return to the ground floor and do not rest in the open position when not in use.
- While maintaining at least one (or more if required by code) ADA-accessible elevator to all floors, consider installing skip-stop elevators, where appropriate for the building.
- Provide daylighting at each floor/roof level of the stair(s) using windows and/or skylights of at least 10 ft<sup>2</sup> (1 square meter) in size. Consider fire-rated glass at egress doors at stair landings to increase lighting and encourage use and daylighting in all corridors as feasible.
- Incorporate permanent artwork, murals, and/or music into the stair environment.
- Incorporate natural ventilation into the stair environment.
- For rehabs, consider working with existing patterns on the property and enhance an existing pathway or stairwell.

### *Activity Spaces*

- Consider active design strategies early on in the project, with tenants, as part of the integrative design process, and determine which features are appropriate based on the expected resident population, building characteristics, and potential related programming strategies.
- Design a courtyard, garden, terrace, or roof that can serve as outdoor space for children's play and/or adult activities.
- Design recreation spaces for versatile use by people of a variety of ages and abilities, including landscape features when possible, as opposed to traditional playground equipment. Playspaces can be works of art and landscape architecture that provide a visual appeal and a pleasant environment for all users.
- In the design of parks and playgrounds, create a variety of climate environments to facilitate activity in different seasons and weather conditions. Provide shaded areas as well as areas that are open to sunlight.
- Locate physical activity spaces in a centrally visible location in the building to help increase awareness and use of these spaces, as well as a sense of safety and security.
- Provide lights on sidewalks and active play areas to extend opportunities for physical activity into the evening.
- Install water bottle fillers adjacent to activity spaces and supply residents with reusable water bottles.
- Provide views to the outdoors from physical activity/playrooms.

## RESOURCES

- City of New York, Affordable Designs for Affordable Housing, 2013. [www1.nyc.gov/assets/doh/downloads/pdf/environmental/affordable-designs.pdf](http://www1.nyc.gov/assets/doh/downloads/pdf/environmental/affordable-designs.pdf)
- City of New York, Active Design Guidelines, 2010. [centerforactivedesign.org/dl/guidelines.pdf](http://centerforactivedesign.org/dl/guidelines.pdf)
- Center for Active Design, Building Design Checklist and Urban Design Checklist. [centerforactivedesign.org/](http://centerforactivedesign.org/)
- Centers for Disease Control and Prevention, Guide to Strategies to Increase Physical Activity in the Community. [www.cdc.gov/physicalactivity/community-strategies/index.htm](http://www.cdc.gov/physicalactivity/community-strategies/index.htm)
- StairWELL. [www.cdc.gov/physicalactivity/index.html?CDC\\_AA\\_refVal=https%3A%2F%2Fwww.cdc.gov%2Fphysicalactivity%2Fworksite-pa%2Ftoolkits%2Fstairwell%2Findex.htm](http://www.cdc.gov/physicalactivity/index.html?CDC_AA_refVal=https%3A%2F%2Fwww.cdc.gov%2Fphysicalactivity%2Fworksite-pa%2Ftoolkits%2Fstairwell%2Findex.htm)
- New York City, Stair Prompt. [www1.nyc.gov/assets/doh/downloads/pdf/tcny/takethestairs.pdf](http://www1.nyc.gov/assets/doh/downloads/pdf/tcny/takethestairs.pdf)
- Robert Wood Johnson Foundation, Active Living Research. [activelivingresearch.org/active-design-supplement-affordable-designs-affordable-housing](http://activelivingresearch.org/active-design-supplement-affordable-designs-affordable-housing)
- Centers for Disease Control and Prevention, Healthier Worksite Initiative: Motivational Signs. [www.cdc.gov/nccdphp/dnpao/hwi/toolkits/stairwell/motivational\\_signs.htm](http://www.cdc.gov/nccdphp/dnpao/hwi/toolkits/stairwell/motivational_signs.htm)
- Task Force on Community Preventive Services, The Community Guide: What Works to Promote Health. [www.thecommunityguide.org/pa/environmental-policy/podp.html](http://www.thecommunityguide.org/pa/environmental-policy/podp.html)
- OCAD University, Georgia Institute of Technology, NYC Department of Health and Mental Hygiene. Active Design Supplement: Affordable Designs for Affordable Housing, 2013. [centerforactivedesign.org/affordablehousingcosts](http://centerforactivedesign.org/affordablehousingcosts)
- Stair use for cardiovascular disease prevention. [www.centreepic.org/files/pdf/Recherche/2009\\_Meyer\\_P\\_Stair\\_Use\\_4\\_CV\\_diz\\_prev.pdf](http://www.centreepic.org/files/pdf/Recherche/2009_Meyer_P_Stair_Use_4_CV_diz_prev.pdf)
- Johns Hopkins Center for Injury Research and Policy, NYC Department of Health and Mental Hygiene, Society for Public Health Education. Active Design Supplement: Promoting Safety, Version 2, 2013. This document offers design guidelines on increasing safety while also promoting health and physical activity within the built environment. [centerforactivedesign.org/promotingsafety](http://centerforactivedesign.org/promotingsafety)
- American Academy of Pediatrics, American Public Health Association, National Resource Center for Health and Safety in Child Care and Early Education. Caring for our children, national health and safety performance standards. Guidelines for early care and education programs, third edition. [nrckids.org](http://nrckids.org)

# 7.12

## OPTIONAL 17 POINTS MAXIMUM

# BEYOND ADA: UNIVERSAL DESIGN

### RATIONALE

Universal Design has been defined as “the design of products and environments to be usable by all people, to the greatest extent possible, without the need for adaptation or specialized design,” the Center for Universal Design (1997). As applied to residential projects, the principles of Universal Design anticipate and plan for a greater diversity of residents’, occupants’, and visitors’ abilities and needs, both today and in the future, thereby supporting and facilitating safety, independence and connectedness for all, including older adults, children, and individuals who have mobility, visual, cognitive, or other impairments.

Social isolation is at epidemic levels, exacerbating mental and physical health issues, relationships, and work. Lower-income populations are more likely to report feelings of loneliness. Social isolation can be a result of or exacerbated by the built environment when it is not reflective of a person’s or specific group’s needs. Our physical environment can help build social cohesion, trust, participation, and stewardship by bringing intentionality to design and developing spaces that are welcoming, accessible, inclusive, and connected. Spaces such as these, that incorporate Universal Design, combat spatial inequities, and help to build cultural resilience and improve physical and mental health outcomes.

As a framework for design, Universal Design is distinct from the goals of accessible or “barrier-free” design. More important, it is also distinct from legally mandated accessibility requirements. Local and federal accessibility laws and regulations provide a base for Universal Design but define only a minimum level of performance to serve people with disabilities. Furthermore, these laws focus overwhelmingly on requirements for wheelchair users, largely overlooking the broader spectrum of mental, physical, sensory, and cognitive needs represented in the United States today.

### REQUIREMENTS

**Optional [up to 10 points]** – In Appendix M, implement Division 1, Best Practices, of the Iowa Green Streets Criteria Universal Design Best Practices Checklist. One point for each Division I section (i.e., Section 1 Entrance, Section 2 Circulation, Section 3 Bathrooms, etc.) completed. Each entire section must be completed to earn 1 point. For example, in Section 1 Entrance, all numbered items 1.1 Stepless Entrance, 1.2 Other Entrances, and 1.3 Other Entrance Features must be completed to earn 1 point.

**Optional [up to 7 points]** – In Appendix M, Implement Division 2, Best Practices, of the Iowa Green Streets Criteria Universal Design Best Practices Checklist. One point for each Division II numbered item (i.e., 1.2, 3.3, 3.6, etc.) completed.

Optional points can be earned for either completing Division 1 or Division 2 activities or a combination of the two.

## RESOURCES

- For more information about the ICC /ANSI A117.1 standard.  
[blog.ansi.org/2017/08/icc-ansi-a117-1-2017-accessible-buildings/](http://blog.ansi.org/2017/08/icc-ansi-a117-1-2017-accessible-buildings/)
- Building Zero-Step Entries  
[www.jlconline.com/projects/building-zero-step-entries\\_o](http://www.jlconline.com/projects/building-zero-step-entries_o)
- Practical Guide to Universal Home Design: Convenience, Ease and Livability  
[www.environmentsforall.org/files/2015/10/practicalguide.pdf](http://www.environmentsforall.org/files/2015/10/practicalguide.pdf)
- Residential Remodeling and Universal Design (Note: Helpful images of best practices.)  
[www.huduser.gov/publications/pdf/remodel.pdf](http://www.huduser.gov/publications/pdf/remodel.pdf)
- Should it Cost More to Build or Renovate With Universal Design?  
[www.stevhoffacker.com/2018/11/10/should-it-cost-more-to-build-or-renovate-with-universal-design/](http://www.stevhoffacker.com/2018/11/10/should-it-cost-more-to-build-or-renovate-with-universal-design/)
- Universal Design Strategies  
[www.stevhoffacker.com/universal-design-strategies/](http://www.stevhoffacker.com/universal-design-strategies/)
- What is Design for Independent Living?  
[www.nahb.org/Education-and-Events/Education/Designations/Certified-Aging-in-Place-Specialist-CAPS/Additional-Resources/What-is-Design-for-Independent-Living](http://www.nahb.org/Education-and-Events/Education/Designations/Certified-Aging-in-Place-Specialist-CAPS/Additional-Resources/What-is-Design-for-Independent-Living)
- Mayor's Office for People with Disabilities, New York City Inclusive Design Guide  
[www.nyc.gov/site/mopd/initiatives/inclusive-design-guidelines.page](http://www.nyc.gov/site/mopd/initiatives/inclusive-design-guidelines.page)
- California Department of Housing and Community Development, Universal Design Model Ordinance.  
[www.hcd.ca.gov/building-standards/state-housing-law-program/universal-design-model-ordinance](http://www.hcd.ca.gov/building-standards/state-housing-law-program/universal-design-model-ordinance)
- National Disability Authority, Centre for Excellence in Universal Design, Universal Design Guidelines: Dementia Friendly Dwellings for People with Dementia, their Families and Careers. [universaldesign.ie/Web-Content-/UD-DFD-Guidelines-Full-Document-non-acc-June-15.pdf](http://universaldesign.ie/Web-Content-/UD-DFD-Guidelines-Full-Document-non-acc-June-15.pdf)
- National Institute of Building Sciences, Design Guidelines for the Visual Environment.  
[www.iowaarchfoundation.org/perspectives/design-guidelines-for-the-visual-environment/](http://www.iowaarchfoundation.org/perspectives/design-guidelines-for-the-visual-environment/)
- U.S. Department of Housing and Urban Development, Residential Remodeling and Universal Design: Making Homes More Comfortable and Accessible.  
[www.huduser.gov/publications/pdf/remodel.pdf](http://www.huduser.gov/publications/pdf/remodel.pdf)

# 7.13

## OPTIONAL 8 POINTS

# HEALING-CENTERED DESIGN

### RATIONALE

Physical environments affect people's sense of worth and dignity. They can lift people up and contribute to healing from various historic, community, or life traumas. Trauma is a set of normal human responses to stressful and threatening experiences. Most people are exposed to some trauma (e.g., witnessing or experiencing violence, natural disaster, serious accident, chronic stress) in their lives and may react differently to the same event or exposure. It is important to consider the potential trauma that building occupants and visitors may carry with them into the building and how the built environment can support healing. Spaces within and surrounding buildings can play a significant role to ensure that building users 1) are not re-exposed or reminded of current or past trauma, and 2) are able to move toward healing through welcoming, safe, and accommodating spaces that promote social and cultural connection.

### REQUIREMENTS

Consider your building's population and the questions answered through the Integrative Design Criterion in Category 1 when evaluating the Options below. Select at least two of the Options below to implement. Implement each of the selected Options with at least two different strategies (strategies are listed in bullet form below each Option). For residential projects, at least one strategy for each Option must be implemented throughout at least 75% of the project's dwelling units.

#### *Option 1*

Provide an environment that promotes feelings of real and perceived safety.

- Review the entire design from the perspective of physical distance between people and incorporate strategies that allow residents to be in control of their physical distance from other people while also promoting opportunities for relationship and community building (ability to be in a public space without having to interact, ability to have control over your physical space, visual awareness of surroundings, and mix of social and more private spaces). These features may include wide hallways, alternative pathways, open design that allows occupants to quickly develop an understanding of what is happening elsewhere in the building, improved lines of sight, or the creation of smaller more intimate spaces near large communal spaces.
- Review the entire design from the perspective of occupant safety and incorporate strategies that allow tenants to feel safe in their spaces and when navigating the building. This may include the reduction of blind spots, removing door undercuts (having full length doors), installation of visible and secure locks, visual connections between units and the street or exterior spaces, or no spaces without windows.
- Review the entire design from the perspective of reliability and incorporate strategies that allow a sense of consistency throughout the building. These features may include the presence or reliability of a resource that may have been a stressor in the past (e.g., drinking fountains, food resource), consistent and clear signage throughout the building, and uniform lighting at building entries and interior paths of travel.

### **Option 2**

Create flexible spaces that allow for personalization and/or manipulation to meet individual and community needs. This pathway includes strategies that allow tenants to alter their environment to meet their specific needs and enable the configuration of the property to adapt and change in accordance with the needs of new or long-term occupants.

- Include at least two different features that allow building occupants control over their environment (e.g., variable lighting, climate systems, shading devices).
- Include resident or community personalization and agency over space and service or program offerings. This may include naming, signage, flexible art exhibit space, and programming.
- Incorporate strategies that allow for ongoing variability in the space, such as moveable partitions to allow spaces to be used for multiple purposes or moveable furniture, allowing individual choice over how much space they have from others.

### **Option 3**

Connect building users to a living landscape and the natural environment. Include at least two of the following elements through the strategies below: plants, water, daylight, natural views.

- Connect interior common spaces to nature by including a green wall or through configurations that allow for views of the outdoors.
- Provide exterior common spaces that promote connection to nature through features such as a mix of planted areas and hardscape. Spaces shall be designed for comfort in all seasons/weather, easily accessible from the interior of the building, and include use-promoting resources such as, at a minimum, permanent seating and drinking water.
- Connect the residential units, offices, and community spaces to nature through either views to nature or a direct physical connection to usable outdoor space such as a patio or balcony.
- Promote occupant exposure to daylight or to indoor lighting that emulates daylight (e.g., timed lighting adjusting to natural light cycles or circadian rhythms) in units, common spaces, and hallways.
- Allow for and provide space for residents to care for pets.

### **Option 4**

Utilize art and culture in project design and programming and promote social connectedness.

- Incorporate art that is generated by and reflective of the community throughout the project. Use this art as a way for residents to frame their narrative and see it reflected in their space.
- Use design strategies in common spaces and dwelling units that are reflective of nature and the local environment through art, materials, color, pattern, and other design elements.
- Create a story for the space that incorporates occupant identity and culture into design elements, allows for occupants to contribute and be engaged, and where occupants can see themselves reflected in the space.

## RECOMMENDATIONS

Engage occupants and building owners or community stakeholders familiar with the anticipated building occupants to tailor the strategies incorporated in each pathway to the needs of those anticipated project users.

As the project team designs healing-centered strategies, use the following considerations as guiding principles:

1. Do not inadvertently retraumatize. Project teams should first consider which strategies to select based on the intention to do no harm in terms of creating new trauma or retraumatizing residents.
2. Consider and be sensitive toward the trauma tenants may hold. This requires tenant engagement and understanding. It is critical to meet tenants where they are and develop strategies around that.
3. Next, consider which strategies will move tenants toward healing.

During this process, consider these best practices:

- Engage the full project team, including architect and interior designer, around the trauma-informed and healing-centered approach. Consider including a mental health professional or other professional who has experience in designing for trauma and healing. The professional can help project teams as they consider:
  - a. Biases as a developer (architect, designer, etc.)
  - b. Acknowledgment of barriers
  - c. Reflections on these biases and barriers
  - d. How to design from a place of cultural context and empathy
- Engage community members or building occupants and build power by incorporating their voices and ensuring that occupants feel represented in the space.
- Use empowering language toward your community throughout this process and the project life cycle.
- Evaluate this process and the strategies incorporated. This evaluation should be used as an opportunity for continual feedback and incorporation of new needs (e.g., questions: Do you see yourself in this space? Does the space make you feel better?).

## RESOURCES

- University of Virginia School of Architecture, Social Equity Impact Protocol for Affordable Housing Redevelopment.
- The Future of Healing, Shifting from Trauma Informed Care to Healing Centered Engagement. [medium.com/@ginwright/the-future-of-healing-shifting-from-trauma-informed-care-to-healing-centered-engagement-634f557ce69c](https://medium.com/@ginwright/the-future-of-healing-shifting-from-trauma-informed-care-to-healing-centered-engagement-634f557ce69c)
- BRIDGE Housing Corporation and The Health Equity Institute, Trauma Informed Community Building: A Model for Strengthening Community in Trauma Affected Neighborhoods. [bridgehousing.com/PDFs/TICB.Paper5.14.pdf](https://bridgehousing.com/PDFs/TICB.Paper5.14.pdf)
- Enterprise Community (2017), Sanderson Apartments Employs Trauma-Informed Design. [www.enterprisecommunity.org/news-and-events/news-releases/sanderson-apartments-employs-trauma-informed-design](https://www.enterprisecommunity.org/news-and-events/news-releases/sanderson-apartments-employs-trauma-informed-design)
-



- Posttraumatic Understanding. Finn, Matthew. The connections between posttraumatic stress and environmental design, Perkins + Will. [static1.squarespace.com/static/586cf7b2be659472709cd98a/t/59f8cc9310952631f619f90f/1509477523905/PosttraumaticUnderstanding\\_2014.pdf](https://static1.squarespace.com/static/586cf7b2be659472709cd98a/t/59f8cc9310952631f619f90f/1509477523905/PosttraumaticUnderstanding_2014.pdf)
- Trauma Informed and Equitable Design Literature Review. Stewards of Affordable Housing for the Future. March 2019.
- Trauma-Informed Community Building and Engagement, April 2018. A guide that contains approaches to supporting residents, including background on trauma and community healing, strategies, and practices for trauma-informed resident engagement, and two case studies. [urban.org/sites/default/files/publication/98296/trauma-informed\\_community\\_building\\_and\\_engagement.pdf](https://urban.org/sites/default/files/publication/98296/trauma-informed_community_building_and_engagement.pdf)
- Living Architecture Performance Tool. [greeninfrastructurefoundation.org/lapt](https://greeninfrastructurefoundation.org/lapt)
- Whole Building Design Guide, VA Healing Environment Design Guidelines. Describes ways to plan and design the key public elements of a healthcare facility to deliver safe, effective, and efficient healthcare to veterans. [www.wbdg.org/ffc/va/design-manuals-pg-18-10/healing-envir](https://www.wbdg.org/ffc/va/design-manuals-pg-18-10/healing-envir)
- Crime Prevention through Environmental Design (CPTED) is a multidisciplinary approach to reducing crime through urban and environmental design and the management and use of built environments. CPTED strategies aim to reduce victimization, deter offender decisions that precede criminal acts, and build a sense of community among inhabitants. [www.cpted.net/](https://www.cpted.net/)
- Institute for Human Centered Design. Dedicated to enhancing the experiences of people of all ages, abilities, and cultures through excellence in design. [www.humancentereddesign.org](https://www.humancentereddesign.org)
- National Child Traumatic Stress Network, Trauma-Informed Care. Resources from training and overview materials that affordable housing development teams may access to learn about trauma-informed work. [www.nctsn.org/trauma-informed-care](https://www.nctsn.org/trauma-informed-care)
- The Center for Active Design, Assembly: Civic Design Guidelines. A playbook for creating well-designed and well-maintained public spaces as a force for building trust and healing divisions in local communities. [centerforactivedesign.org/assembly](https://centerforactivedesign.org/assembly)
- Gehl Institute, Public Life Tools. Most useful in planning exterior spaces, these tools help measure and plan for the relationship between spaces and the public life that takes place there. Includes the Twelve Quality Criteria, which is used to evaluate whether various features of a public space are protective, comfortable, and enjoyable for people spending time there. [gehlpeople.com/tools/](https://gehlpeople.com/tools/)
- SITES Rating System v2 Section 6: Site Design — Human Health + Well-Being. [www.sustainablesites.org/certification-guide](https://www.sustainablesites.org/certification-guide)
- Stressed Spaces: Mental Health and Architecture. Health Environments Research & Design Journal. Connellan, K.; Gaardboe, M.; Riggs, D.; Due, C.; Reinschmidt, A.; and Mustillo, L. (2013). (Vendome Group LLC), 6(4), 127–168.

“To be here helps me get a fresh state of mind. It has been a beautiful experience.”

Resident of Enterprise Green Communities property

## OPERATIONS, MAINTENANCE & OCCUPANT ENGAGEMENT

### INTRODUCTION CRITERIA CHECKLIST

- 1 INTEGRATIVE DESIGN
- 2 LOCATION +  
NEIGHBORHOOD FABRIC
- 3 SITE IMPROVEMENT
- 4 WATER
- 5 OPERATING ENERGY
- 6 MATERIALS
- 7 HEALTHY LIVING  
ENVIRONMENT
- 8 OPERATIONS,  
MAINTENANCE  
& OCCUPANT  
ENGAGEMENT

### APPENDIX

EDUCATIONAL MATERIALS AND ORIENTATIONS HELP EDUCATE BUILDING OCCUPANTS AND STAFF ON FEATURES THAT WERE DESIGNED TO DELIVER HEALTH, ECONOMIC, AND ENVIRONMENTAL BENEFITS, AS WELL AS THEIR ROLE IN REALIZING THOSE BENEFITS IN THEIR OWN LIVES.

# 8.1

## BASELINE

*FOR ALL PROJECTS EXCEPT SINGLE FAMILY RESIDENTIAL*

# BUILDING OPERATIONS & MAINTENANCE MANUAL AND PLAN

## RATIONALE

Regular building Operations & Maintenance (O&M) practices using green methods minimize building maintenance needs and utility consumption, and provide a healthy, safe, and durable working and living environment. Developing a building O&M manual and complementary plan throughout the project design, development, and construction stages allows the project team to properly customize these documents with the input of project installers.

## REQUIREMENTS

Develop a manual with thorough building O&M guidance and a complementary accountability plan. The manual and plan should be developed over the course of the project design, development, and construction stages so that knowledge can be transferred from this stage of the project life cycle to the operations and asset management stage. At minimum, the manual and plan shall address the following topics:

- O&M guidance for all mechanical and electrical equipment and appliances (building level and dwelling unit level)
- HVAC specifications, and O&M schedules
- Refrigerant management
- Operations, maintenance, and replacement guidance for any other specialized systems (e.g., solar photovoltaics, solar water heating, ground source heating, cogen) within the project along with evidence of training completed for these systems
- Location of mechanical, electrical, gas, and water-system turnoffs
- Lighting equipment specifications and replacement guidance
- Landscaping and hardscaping specifications and maintenance plan, including any specific instructions for community gardens or growing spaces
- Green cleaning product specifications and cleaning schedules
- Integrated pest management protocol
- Maintenance of active recreation and play spaces (e.g., playgrounds, ground markings, exercise equipment)
- If the project includes either a cooling tower or a centralized hot water system, or is more than 10 stories in height, also include the Legionella water management plan developed via Criterion 4.3.
- Protocol for reviewing and responding to utility data consumption information
- An occupancy turnover plan that describes the dwelling unit turnover protocol, including all materials that are frequently replaced at turnover



## RECOMMENDATIONS

Begin creating a thorough and well-developed O&M manual and plan well before construction completion. Work with designers, systems installers, and operations staff to assemble critical information and schedules for best-practice operations and maintenance strategies.

### ***Prior to and during construction:***

During the design process, keep a running list of how maintenance and landscaping teams and occupants may need to be involved with the building in order to ensure that it will perform as intended. Once the project team has completed the integrative design process (see Category 1), amend templates of O&M documents with project-specific information for maintenance staff and occupants. By working in this manner, the building O&M manual and plan will be informed by the development process and completed by the time the project is ready for occupancy.

- Identify the senior management position(s) with oversight responsibility for O&M and the job roles responsible for producing, managing, and/or implementing the manual and plan.
- Ensure that the building performance goals/requirements that were established for the project during integrative design will be included in the O&M manual and plan.
- Create a knowledge-transfer plan to ensure that accurate as-built information is captured during construction, startup, and commissioning, and integrated into the O&M manual and plan (e.g., if possible, create a video of the commissioning agent or system installer showing key maintenance checks to use when training staff).
- Discuss your building O&M training plan to ensure that responsible staff will be up to speed on the operation of the building prior to turnover and occupancy.
- Develop a succession plan to ensure that important information is retained from departing staff and transferred to new staff. This could include an exit interview checklist, maintenance log review, etc.

### ***As construction nears completion and into operations:***

- Finalize your building O&M manual and plan. Clearly identify key operations and maintenance activities, assign those activities to a person/job role, and establish a schedule to verify that maintenance is performed.

### ***To enhance your O&M manual and plan, include:***

- Account information on your energy and water performance tracking software. Identify who will monitor this account and at what interval, and what procedures will take place if irregularities are discovered.
- HVAC maintenance plans. Develop a maintenance schedule for HVAC systems, and include assignments of key tasks to specific job roles. Create a system to track when/what maintenance tasks were completed.
- Information on lighting equipment, including specs for replacement bulbs and a maintenance strategy for when to replace inaccessible fixtures (e.g., what percentage of bulbs/diodes can fail in any one lamp pylon before you install replacements).
- Location of mechanical, electrical, gas, and water-system turnoffs.
- Irrigation system maintenance plans. Develop a periodic visual inspection of functions (since irrigation systems are often scheduled to operate when O&M staff are off duty).
- Landscaping and hardscapes (paved surfaces) review protocols. Develop an inspection schedule of landscaping and paving and assign key tasks to specific job roles.

- Green cleaning products and cleaning schedules. Specify products, vendors, schedule, and assignments of key tasks to specific job roles. Create a system to track when actions are completed.
- A written Integrated Pest Management policy (see Category 7) aimed at preventing pests and addressing conditions conducive to pests. Repair and maintain structures and grounds to minimize pest-related conditions. Develop resident guidelines related to pesticide use, housekeeping, and prompt reporting of pest problems, such as cockroaches, rodents, and bed bugs. Ensure that anyone applying pesticides is licensed and working under a scope that includes IPM provisions.
- If the project is utilizing recycled water (greywater), design and institute a policy that requires biodegradable soaps, cleaners, and other products if they are going to be flushed down the drains.
- Video-record installers of mechanical systems explaining best practices for regular maintenance and strategies to address common system problems. Use this video as part of your maintenance staff training.
- Provide maintenance staff with local information for handling hazardous waste, including where to recycle fluorescent and compact fluorescent lighting (CFLs).

## RESOURCES

- Enterprise Green Communities, Building Maintenance Manual Templates in Information Resources. [www.enterprisecommunity.org/resources/green-operations-and-maintenance-manual-template-13403](http://www.enterprisecommunity.org/resources/green-operations-and-maintenance-manual-template-13403)
- San Francisco Department of the Environment, Pest Prevention by Design: Authoritative guidelines for designing pests out of structures. [sfenvironment.org/article/pest-prevention-by-design-guidelines](http://sfenvironment.org/article/pest-prevention-by-design-guidelines)
- University of Minnesota. For language on residential IPM policy, the university offers the following resource. [www.mnipm.umn.edu/](http://www.mnipm.umn.edu/)
- National Center for Healthy Housing, Healthy Homes Maintenance Checklist. [www.nchh.org/Portals/0/Contents/Maintenance\\_Checklist2009.pdf](http://www.nchh.org/Portals/0/Contents/Maintenance_Checklist2009.pdf)
- Stewards of Affordable Housing for the Future, Multifamily Energy and Water Management Toolkit. This toolkit (including checklists, worksheets, and resources) helps improve energy and water management, reduce costs and spending, and minimize environmental impacts over the long-term, while helping to preserve affordable properties. [www.sahfnet.org/resources/downloads/multifamily-energy-and-water-toolkit](http://www.sahfnet.org/resources/downloads/multifamily-energy-and-water-toolkit)
- NYC Department of Health and Mental Hygiene, IPM Toolkit for Building Managers and Staff. [www1.nyc.gov/assets/doh/downloads/pdf/pesticide/ipm-toolkit.pdf](http://www1.nyc.gov/assets/doh/downloads/pdf/pesticide/ipm-toolkit.pdf)
- Federal Energy Management Program, Operations & Maintenance Best Practices: A Guide to Achieving Operational Efficiency. [www.energy.gov/eere/femp/downloads/operations-and-maintenance-best-practices-guide](http://www.energy.gov/eere/femp/downloads/operations-and-maintenance-best-practices-guide)
- ENERGY STAR Maintenance Checklist. [www.energystar.gov/index.cfm?c=heat\\_cool.pr\\_maintenance](http://www.energystar.gov/index.cfm?c=heat_cool.pr_maintenance)
- ASHRAE Guideline 1.4P: 2014, Published Guideline Procedures for Preparing Facility Systems. Manuals provides procedures for producing a Systems Manual as a resource for training, operations, maintenance and upgrading of facilities. [www.eepformance.org/uploads/8/6/5/0/8650231/systemsmanualsgdl1\\_4-201x\\_chair\\_approved.pdf](http://www.eepformance.org/uploads/8/6/5/0/8650231/systemsmanualsgdl1_4-201x_chair_approved.pdf)
- ASHRAE Guideline 32-2018, Sustainable, High-Performance Operations and Maintenance. Offers guidance for operating and maintaining buildings with goals of sustainability and high performance in mind. [www.techstreet.com/standards/guideline-32-2018-management-for-sustainable-high-performance-operations-and-maintenance?product\\_id=2021318](http://www.techstreet.com/standards/guideline-32-2018-management-for-sustainable-high-performance-operations-and-maintenance?product_id=2021318)
- ASHRAE Training for Operations & Maintenance. [www.ashrae.org/education--certification/self-](http://www.ashrae.org/education--certification/self-)



---

[directed-or-group-learning/fundamentals-of-building-operation-maintenance-and-management](#)

- GPRO Operations & Maintenance Essentials provides tools for building professionals to transition from conventional to sustainable operations. [www.gpro.org/operations-maintenance](http://www.gpro.org/operations-maintenance)

## 8.2

### **BASELINE** *FOR ALL MULTIFAMILY, COMMERCIAL, NONPROFIT AND MIXED-USE PROJECTS* **EMERGENCY MANAGEMENT MANUAL**

#### **RATIONALE**

In the event of an emergency, time is of the essence. Creating and socializing a plan for building managers and occupants before an emergency occurs increases the likelihood that disturbances due to the emergency (whether it be flooding, tornado, earthquake, power outages, or another disturbance) can be appropriately mitigated.

#### **REQUIREMENTS**

Provide a manual on emergency operations targeted toward O&M staff and other building-level personnel. The manual should address responses to various types of emergencies, leading with those that have the greatest probability of negatively affecting the project. The manual should provide guidance as to how to sustain the delivery of adequate services throughout an emergency and cover a range of topics including but not limited to:

- communication plans for staff and tenants to use in the event of an emergency
- useful contact information for public utility and other service providers
- infrastructure and building “shutdown” procedures
- plan for regular testing of backup energy systems, if these exist

Emergency Management Manuals should be responsive to information generated from successful completion of Category 1 and, if selected, Criterion 4.7, Criterion 5.8, Criterion 5.9, and Criterion 5.10.

This information should be readily available to all building tenants, staff, and visitors.

#### **RECOMMENDATIONS**

- Emergency Maintenance Manuals should be updated annually (at a minimum) in both digital and hardcopy formats and located in a well-marked location.
- Plan for people with disabilities and/or mental, physical, sensory, and cognitive needs in the Emergency Management Manual. Special populations of concern are users of electrically powered life-sustaining equipment. If utility costs are covered in rent, building owners can communicate to the utility provider that a person in the building uses such equipment. For buildings in which tenants directly pay for utilities, encourage registration with the utility provider for tenants in which users of such equipment reside. Registration allows for utilities to notify users of power outages, as well as to potentially conduct check-ins during a power outage.
- Reviewing and updating all Emergency Maintenance Manuals should be built into the job description and performance requirements of staff members.
- Host trainings and/or drills to test emergency plans and test communication and coordination across staff and residents.



- Consider having at least 1 staff member for every 50 occupants + staff trained in first aid, CPR, and the use of automated external defibrillators (AEDs), and include information about these resources within the Emergency Management Manual.
- Consider including multiple types of contact information for building managers and other staff in the communication plan and sharing with residents (e.g., cell phone, email).
- Consider utilizing a phone app to contact tenants, provide information and reminders to charge devices, find emergency power and charging locations.

## RESOURCES

- Enterprise Green Communities, Disaster Response Staffing Plan. [www.enterprisecommunity.org/solutions-and-innovation/disaster-recovery-and-rebuilding/ready-respond-disaster-staffing-toolkit](http://www.enterprisecommunity.org/solutions-and-innovation/disaster-recovery-and-rebuilding/ready-respond-disaster-staffing-toolkit)
- “Ready” is a public service campaign designed to educate and empower Americans to prepare for and respond to emergencies, including natural and man-made disasters. The goal of the campaign is to get the public involved and ultimately to increase the level of basic preparedness across the nation. [www.ready.gov](http://www.ready.gov)
- Federal Emergency Management Agency. [www.fema.gov](http://www.fema.gov)
- American Red Cross. [www.redcross.org](http://www.redcross.org)
- Seattle Office of Emergency Management provides many valuable resources, including a Resident Disaster Recovery Booklet translated into several languages. [www.seattle.gov/emergency/publications](http://www.seattle.gov/emergency/publications)
- Urban Green, Building Resiliency Task Force Report: Chapter 4: Better Planning, June 2013. [urbangreencouncil.org/sites/default/files/2013\\_brtf\\_summaryreport\\_0.pdf](http://urbangreencouncil.org/sites/default/files/2013_brtf_summaryreport_0.pdf)
- Opportunities Assessment Tool. While these are building assessment tools, rather than for people, review DC’s Resilience [doee.dc.gov/climateready](http://doee.dc.gov/climateready)



## 8.3

# BASELINE OCCUPANT MANUAL

### RATIONALE

Materials that share information on the features of the building will better enable occupants to fully realize the environmental, health, and economic investments that have been made to the property.

### REQUIREMENTS

Provide a guide for building occupants, homeowners, and renters that explains the intent, benefits, use, and maintenance of the building's or their home's green features and practices. The Occupant Manual should encourage green and healthy activities.

A range of topics should be discussed. Those topics shall include, but are not limited to:

- a description of the Iowa Green Streets Criteria included in the project
- a routine maintenance plan, outlining responsibilities of occupants and maintenance staff with contact information for occupants to use for maintenance issues, as applicable
- HVAC operation
- green cleaning guidelines
- smoke-free policy
- location of electrical, mechanical, gas, and water turnoffs
- recycling and waste management
- integrated pest management protocols
- interior Active Design features
- information on community connectivity amenities, including transportation, car-share, bike-share, and other accessibility features
- community garden and other fresh food resources
- energy and water consumption information
- if applicable, procedures to contact building management in the case of a building-related problem
- any other systems that are part of the home

## RECOMMENDATIONS

- When developing your Occupant Manual and engagement information, include graphics, images, videos, and social media information to make your material more engaging, and in turn more useful.
- During the design process, keep a running list of how maintenance and landscaping teams and occupants may need to be involved with the building in order to ensure that it will perform as intended. Once the project team has completed the integrative design process (see Category 1), amend templates of the O&M documents and Occupant Manual with project-specific information. By working in this manner, these documents will be informed by the development process and completed by the time the project is ready for occupancy.
- Develop an Integrated Pest Management policy and, as part of that, develop tenant guidance related to pesticide use, housekeeping and prompt reporting of pest problems with cockroaches, rodents, and bed bugs. Ensure that anyone applying pesticides is licensed and working under a scope that includes IPM provisions.
- Provide tenants with information about local transportation options by including maps, public transit schedules, car- and bike-share programs, and the building's bicycle amenities.
- Provide tenants with maps of neighborhood locations for physical activity and healthy food amenities, including farmers markets, community gardens, walking trails, parks, playgrounds, and exercise facilities.
- Amplify the impact of tenants having access to fresh food (through gardening spaces or other means) by hosting cooking classes so that they can learn how to use their produce to make healthy meals.
- Consider labeling trash, recycling, and composting receptacles throughout the building. "Trash" can become "landfill" can and is made visually distinct from recycling containers through the use of consistent colors. Also provide examples and instructions for what materials are recyclable, and for composting, when available.
- Provide residents with local information for handling household hazardous waste, including compact fluorescent bulbs (CFLs).
- Provide tenants with the building's smoke-free policy during orientation.
- If the project is utilizing greywater, design and institute a policy that requires biodegradable soaps, cleaners, and any other product types that are going to be flushed down the drains.
- Consider bulk purchase of non-toxic cleaning materials for residents to purchase at a discount.
- Consider including ENERGY STAR "Best Practices" information in the Occupant Manual. Select a product type, click on "Buying Guidance," and scroll down to the bottom of the page to select "Best Practices" products.
  - For washers and dryers: [www.energystar.gov/index.cfm?c=clotheswash.clothes\\_washers\\_performance\\_tips](http://www.energystar.gov/index.cfm?c=clotheswash.clothes_washers_performance_tips)
  - For refrigerators: [www.energystar.gov/index.cfm?c=refrig.pr\\_best\\_practices\\_refrigerators](http://www.energystar.gov/index.cfm?c=refrig.pr_best_practices_refrigerators)
  - For dishwashers: [www.energystar.gov/index.cfm?c=dishwash.pr\\_best\\_practices](http://www.energystar.gov/index.cfm?c=dishwash.pr_best_practices)
  - For additional best practices on ENERGY STAR products: [www.energystar.gov/index.cfm?c=products.pr\\_find\\_es\\_products](http://www.energystar.gov/index.cfm?c=products.pr_find_es_products)

---

## RESOURCES

- Center on Sustainable Communities Homeowner Handbook.  
[issuu.com/iowacosc/docs/coschomeownerhandbook](http://issuu.com/iowacosc/docs/coschomeownerhandbook)
- Enterprise Community Partners. The Resource Center hosts a variety of resident engagement tools, trainings, and sample manuals. Search for “Resident Engagement.”  
[www.enterprisecommunity.com/resources](http://www.enterprisecommunity.com/resources)
- Connecticut Department of Environmental Protection, A Green Home Is a Healthy Home. This is a simple brochure with a readable layout and good presentation.  
[www.ct.gov/deep/lib/deep/p2/individual/healthyhome.pdf](http://www.ct.gov/deep/lib/deep/p2/individual/healthyhome.pdf)
- NYC Department of Health and Mental Hygiene, Pest Management Tips for Building Residents.  
[www1.nyc.gov/assets/doh/downloads/pdf/pesticide/mgmt-tips.pdf](http://www1.nyc.gov/assets/doh/downloads/pdf/pesticide/mgmt-tips.pdf)
- Home Energy Resource MN. This site provides information for homeowners on maintaining their home. It includes seasonal checklists and step-by-step instructions for general maintenance, as well as special instructions for new home buyers on maintaining their home during its first year.  
[www.homeenergyresourcemn.org/](http://www.homeenergyresourcemn.org/)
- Canada Mortgage and Housing Corporation, Information for Occupants. Information on mold identification and remediation in existing homes.  
[www.cmhc-schl.gc.ca/en/maintaining-and-managing/managing-first-nation-properties/maintenance-solutions/mould-in-housing/information-for-occupants](http://www.cmhc-schl.gc.ca/en/maintaining-and-managing/managing-first-nation-properties/maintenance-solutions/mould-in-housing/information-for-occupants)

## 8.4

# BASELINE WALK-THROUGHS AND ORIENTATIONS TO PROPERTY OPERATION

### RATIONALE

An orientation to the building and community helps educate residents, tenants, property manager(s), and building operations staff about the green features that were designed to deliver health, economic, and environmental benefits, as well as their role in realizing those benefits in their own lives and the lives of future residents. Without an orientation to the information included in the guides created through Criteria 8.1 – 8.3, that valuable information may not be put to use, and the project's long-term goals may not be met.

### REQUIREMENTS

Provide a comprehensive walk-through and orientation for all tenants and for all property manager(s) and buildings operations staff. Orient new occupants to the property's green features before move-in, or within 90 days of move-in. Orient all property managers and building operations staff within 90 days of initial occupancy on building maintenance and unit turnover procedures. For staff joining after the initial orientation, provide walk-through and orientation to green features within their first 90 days. For all orientations and walk-throughs, share the list of Iowa Green Streets Criteria that were implemented in the project and use the appropriate manuals (see Criteria 8.1–8.3) as the base of the curriculum. Review the project's green features, O&M procedures, and emergency protocols.

For home-ownership properties, walk-throughs and orientations should take place at sale.

### RECOMMENDATIONS

- During Property Management and Tenant Services staff trainings, focus on how the features of the building function and are maintained, and how those features help the occupants by providing comfort, protecting health, saving money, conserving resources, and being better stewards of the environment. It is important for all staff to understand how the building and systems were designed to operate so that issues can be identified and addressed promptly.
- Tenant orientations should focus on engaging occupants in the process of both creating and maintaining a green and healthy environment as well as increasing awareness of on-site and nearby physical activity and healthy food amenities. Engagement orientations should be tailored to tenants and their needs (e.g., families, older adults) and educate occupants on how to operate key features and building resources (e.g., recycling, thermostats, fans, lighting) and explain why certain building elements/features/materials were selected (e.g., less carpet in favor of smooth flooring improves indoor air quality). This thorough orientation will lead to collective improved outcomes, such as how occupant behavior affects energy, water, and materials use, as well as health outcomes. The orientation should also stress the important role that tenants play in reporting building-related problems so that issues can be addressed in a timely fashion.



- 
- Consider providing tenants with a green, healthy living packet, including green cleaning materials, healthy recipes, recycling information, and important contact information in case of any problems.
  - Engage occupants at regular intervals (e.g., move-in, 3 months, 1 year, then annually) that coincide with existing tenant engagement to check in on behaviors and the potential need for assistance.
  - Provide residents with local information for handling household hazardous waste, including compact fluorescent bulbs (CFLs).
  - Educate occupants and staff on building protocols for what to do in the case of an evacuation or shelter-in-place scenario. Consider providing key staff and key tenants with additional training and “go-bags” so that they can help occupants during an emergency.

## 8.5

# BASELINE ENERGY AND WATER DATA COLLECTION AND MONITORING

### RATIONALE

A utility data-collection and monitoring system allows the IEDA, project owners, on-site staff, and occupants to understand project performance and accurately determine the cost-benefit of energy efficiency improvements. This information may be used to influence future retrofit and repair work, as well as to identify day-to-day performance issues as they arise. If an issue is identified, appropriate actions can be taken to maximize project durability, cost savings, and health benefits associated with the goals of the project.

### REQUIREMENTS

Collect and report project energy and water performance data to the Iowa Economic Development Authority annually on October 1 and upon request from IEDA.

#### ***RESIDENTIAL AND MIXED-USE PROJECTS***

Property owner/developer must agree to collect utility release forms from a percentage of occupants/units to track actual utility data of a sample of residential or non-residential spaces for a minimum of five years.

(Example: Main Street redevelopment project with two upper-story residential units and one first-floor commercial bay would collect release forms and data from at least one residential unit and the commercial bay). The following table identifies the percentage of units the property owner/developer must collect and track utility data, as based on the project size in total number of units.

Number of units	Percentage of units
0 – 25 units	50%
25 – 100 units	25%
100+ units	15%

This data must be maintained in a manner that allows staff to easily access and monitor it such as ENERGY STAR Portfolio Manager for non-residential properties, enabling them to make informed operations and capital planning decisions. Also allow Iowa Economic Development Authority access to this data.

#### ***OWNER-OCCUPIED PROJECTS***

For owner-occupied units, residents shall collect and monitor their energy and water performance data in a manner that allows for easy access and review, and that provides the ability to influence home operations for at least 5 years from time of first occupancy. Also allow the Iowa Economic Development Authority access to this data.

#### ***NON-RESIDENTIAL PROJECTS***

For non-residential properties, collect and monitor project energy and water performance data in ENERGY STAR Portfolio Manager for 100% of accounts for a minimum of five years. Allow the Iowa Economic Development Authority access to this data.

## RECOMMENDATIONS

- Make tenant utility access release(s) an opt-out, rather than an opt-in, component of lease-up to provide property management with access to utility data for benchmarking/tracking. This data will allow maintenance staff to proactively identify poorly performing systems and identify other comfort issues that often go unreported, leading to major systems failure.
- Ensure that the training for tenants and building maintenance staff includes information on how to effectively use the data-collection, monitoring, and reporting system. Engage tenants whenever possible in utility reduction campaigns.
- Carefully consider metering and/or utility monitoring configuration of your building to not just meet your needs for utility billing, but also for diagnostics of future potential energy issues. Providing information to residents on the cost and usage associated with the electricity consumption in their unit may reduce energy use. Owners being cognizant of the disaggregated dominant sources of energy consumption can use a proactive operations and maintenance approach, addressing outlier conditions in real-time. The metering and monitoring systems should be specified in the Integrative Design stage, tracked through O&M procedures, and shared with residents and staff.

“I haven’t been placed here to live; I’ve been placed here to succeed.”  
Resident of Enterprise Green Communities property

## RESOURCES

- Enterprise Green Communities, Utility Benchmarking FAQs. Provides instructions as to how to share view access for common utility benchmarking platforms.
- U.S. Department of Housing and Urban Development, Benchmarking 101, Utility Benchmarking Step-by-Step, and Policies and Programs. HUD’s Multifamily Utility Benchmarking Toolkit is a comprehensive guide to utility benchmarking for the multifamily sector, with three sections. [www.hudexchange.info/programs/utility-benchmarking/toolkit/](http://www.hudexchange.info/programs/utility-benchmarking/toolkit/)
- American Council for an Energy-Efficient Economy, Benchmarking Initiatives in the Multifamily Market. Includes best practices for this sector. [aceee.org/sector/local-policy/toolkit/benefits-benchmarking](http://aceee.org/sector/local-policy/toolkit/benefits-benchmarking)
- ENERGYSTAR, Portfolio Manager, Quick Reference Guide for Multifamily Housing. Portfolio Manager is a free, online, interactive energy management tool that allows you to measure and track your building’s energy and water consumption, identify investment priorities, and verify improvements over time. Multifamily housing communities can use it to track weather-normalized energy use intensity, energy costs, greenhouse gas emissions, and water consumption. [www.energystar.gov/buildings/tools-and-resources/portfolio-manager-quick-start-guide](http://www.energystar.gov/buildings/tools-and-resources/portfolio-manager-quick-start-guide)
- Private, fee-based benchmarking and utility tracking tools are available. Among others, these include WegoWise ([www.wegowise.com](http://www.wegowise.com)), Energy Score Cards ([www.energyscorecards.com](http://www.energyscorecards.com)), and eGauge ([www.egauge.net](http://www.egauge.net))
- U.S. Department of Housing and Urban Development. Approved sampling methodologies: Appendix C of the Better Buildings Challenge Data Manual: [files.hudexchange.info/resources/documents/Better-Buildings-Challenge-Data-Tracking-Manual-Multifamily-Sampling-Protocol.pdf](http://files.hudexchange.info/resources/documents/Better-Buildings-Challenge-Data-Tracking-Manual-Multifamily-Sampling-Protocol.pdf) and Part VI of HUD Notice H-2015-04: [www.hud.gov/sites/documents/15-04HSGN.PDF](http://www.hud.gov/sites/documents/15-04HSGN.PDF)
- U.S. Environmental Protection Agency. Portfolio Manager also is designed to create a Water Score, which can compare actual consumption to the model. [www.epa.gov/watersense/water-score-multifamily-housing](http://www.epa.gov/watersense/water-score-multifamily-housing)



## APPENDICES

**APPENDIX A:** GREEN DEVELOPMENT PLAN AND CHECKLIST

**APPENDIX B:** CERTIFICATION OF INTENT TO COMPLY

**APPENDIX C:** CERTIFICATION OF CONSTRUCTION DOCUMENT COMPLIANCE

**APPENDIX D:** CERTIFICATION OF COMPLIANCE AT END OF CONSTRUCTION

**APPENDIX E:** ENERGY PERFORMANCE CERTIFICATION

**APPENDIX F:** PROJECT PLAN AND SPEC BOOK CHECKLIST

**APPENDIX G:** AIR SEALING KEY POINTS

**APPENDIX H:** INTEGRATED DESIGN AGENDA AND OUTCOMES TEMPLATE

**APPENDIX I:** STORMWATER MANAGEMENT MILESTONE CHECKLIST

**APPENDIX J:** CONSTRUCTION TYPOLOGY DEFINITIONS

**APPENDIX K:** PROJECT PRIORITIES SURVEY

**APPENDIX L:** SCAQMD TABLES FOR USE WITH CRITERION 6.4

**APPENDIX M:** UNIVERSAL DESIGN CHECKLIST

**APPENDIX N:** GLOSSARY





---

## APPENDIX A

### GREEN DEVELOPMENT PLAN AND CHECKLIST

- [Green Development Plan & Checklist \(Appendix A\)\[Excel\]](#)
- [Green Development Plan & Checklist \(Appendix A\)\[PDF\]](#)



## APPENDIX B

### CERTIFICATION OF INTENT TO COMPLY

**REQUIRED: SUBMIT THIS CERTIFICATION AT TIME OF APPLICATION.**

The project applicant and project architect/project designer are required to sign the certification below at the time of application submittal to the Iowa Economic Development Authority. By signing this certification, the project applicant and project architect/project designer are certifying their intent to comply with all of the Iowa Green Streets Criteria applicable to the project as determined by the Iowa Economic Development Authority. This certification also certifies the intent to complete the optional Iowa Green Streets Criteria proposed in the applicant's proposal. A fillable PDF version of this form is available here: [iowaeda.com/userdocs/programs/AppxB-CertificationOfIntentToComplyForm.pdf](http://iowaeda.com/userdocs/programs/AppxB-CertificationOfIntentToComplyForm.pdf)

To be Completed by Applicant	
Signature:	
Name:	
Title:	
Tel. No.:	
E-mail:	
Accreditation: (if applicable)	
Date:	

To be Completed by Project Architect/Project Designer	
Signature:	
Name:	
Title:	
Tel. No.:	
E-mail:	
Accreditation: (license/ licensing body)	
Date:	



## APPENDIX C

# CERTIFICATION OF CONSTRUCTION CONTRACT DOCUMENT COMPLIANCE

**REQUIRED: SUBMIT THIS CERTIFICATION PRIOR TO STARTING CONSTRUCTION.**

The project applicant/recipient and project architect/project designer are required to sign the certification below prior to commencement of construction. By signing this certification, the project applicant and project architect/project designer are certifying that the construction documents comply with all of the Iowa Green Streets Criteria applicable to the project as determined by the Iowa Economic Development Authority. This certification also certifies that the construction documents comply with all optional Iowa Green Streets Criteria in the applicant's project proposal. A fillable PDF version of this form is available here:

[iowaeda.com/userdocs/programs/AppxC-CertOfConstContractDocComplianceForm.pdf](http://iowaeda.com/userdocs/programs/AppxC-CertOfConstContractDocComplianceForm.pdf)

To be Completed by Applicant/Recipient	
Signature:	
Name:	
Title:	
Tel. No.:	
E-mail:	
Accreditation: (if applicable)	
Date:	

To be Completed by Project Architect/Project Designer	
Signature:	
Name:	
Title:	
Tel. No.:	
E-mail:	
Accreditation: (license/ licensing body)	
Date:	

## APPENDIX D



## CERTIFICATION OF COMPLIANCE AT END OF CONSTRUCTION

**REQUIRED: SUBMIT THIS CERTIFICATION AT TIME OF CONSTRUCTION COMPLETION.**

The project applicant/recipient, project architect/project designer, general contractor and HVAC contractor are required to sign the certification below at time of construction completion. By signing this certification, all signing parties are certifying that the project as constructed complies with all of the Iowa Green Streets Criteria applicable to the project as determined by the Iowa Economic Development Authority. This certification also certifies that the project as constructed complies with all of the optional Iowa Green Streets Criteria in the applicant's project proposal. A fillable PDF version of this form is available here:

[iowaeda.com/userdocs/programs/AppxD-CertificationOfComplianceEndOfConstForm.pdf](http://iowaeda.com/userdocs/programs/AppxD-CertificationOfComplianceEndOfConstForm.pdf)

To be Completed by Applicant/Recipient	
Signature:	
Name:	
Title:	
Tel. No.:	
E-mail:	
Accreditation: (if applicable)	
Date:	

To be Completed by Project Architect/Project Designer	
Signature:	
Name:	
Title:	
Tel. No.:	
E-mail:	
Accreditation: (license/licensing body)	
Date:	

To be Completed by General Contractor	



Signature:	
Name:	
Title:	
Tel. No.:	
E-mail:	
Accreditation: (license/licensing body)	
Date:	

To be Completed by HVAC Contractor	
Signature:	
Name:	
Title:	
Tel. No.:	
E-mail:	
Accreditation: (license/ licensing body)	
Date:	

## APPENDIX E



## ENERGY PERFORMANCE CERTIFICATION

### REQUIRED:

- Residential Projects (<4 stories) – Energy Rater submits Home Energy Rating System (HERS) certificate, Code Certificate, and signs certification below for submittal by project applicant/recipient.
- Commercial or Residential Projects >3 stories – Energy Rater/Energy Professional/Commissioning Agent submits Code Certificate and energy modeling information and completes and signs certification below for submittal by project applicant/recipient.

The project's independent, third-party energy rater or energy professional for non-residential projects is required to sign the certification below at time of construction completion. By signing this certification, the Energy Rater is certifying that the project, as constructed, complies with all of the Iowa Green Streets Criteria energy related criteria applicable to the project as determined by IEDA including the following criteria.

- 5.1a, Building Performance Standard – New Construction: Single Family and Multifamily
  - Energy performance requirements in Air Barrier and Insulation Inspection Component Guide and Energy Performance Table in Criterion 5-1 were met or project achieved Energy Star certification.
  - HERS Index of 61 or better (HERS  $\leq$  56 required for disaster recovery housing projects).
  - All equipment installed, met or exceeded the minimum performance requirements in the energy performance table in Criterion 5-1.
- 5.1b, Building Performance Standard – Rehab Single Family and Multifamily
  - Applicable energy performance requirements in Air Barrier and Insulation Inspection Component Guide and Energy Performance Table in Criterion 5-1 were met or project achieved Energy Star certification.
  - Air infiltration rate of  $\leq$  0.30 CMF50 for Substantial Rehab and  $\leq$  0.40 CFM50 for Moderate Rehab per square feet of dwelling unit enclosure area was achieved.
  - Insulation installed as part of the rehab achieved Grade I installation per ANSI/RESNET/ICC Std. 301 or Grade II cavity insulation for assemblies that contain a layer of continuous, air impermeable insulation  $\geq$  R-5.
  - Completed and passed current version of ENERGY STAR Certified Homes or MFNC HVAC System Quality Installation Contractor Checklist and ENERGY STAR Certified Homes HVAC System Quality Installation Rater Checklist.
  - HERS Index of 85 or better achieved (See exceptions in Criterion 5.1).
- 5.1c, Building Performance Standard – New Construction: Commercial, Nonprofit, Mixed-Use
  - Applicable energy performance requirements in Air Barrier and Insulation Inspection Component Guide and Energy Performance Table in Criterion 5-1 were met.
  - Slab insulation and pre-drywall thermal bypass inspection passed by a third-party energy rater or commissioning agent.
  - Energy performance requirement to exceed by  $\geq$  10% the current version of ASHRAE 90.1 as coordinated with the adopted edition of the IECC for the State of Iowa was achieved.
  - Building was commissioned by a third-party and the commissioning report submitted to IEDA.
  - Completed and submitted the required Energy Review Form (only projects > 100,000 cu. Ft.)
- 5.1d, Building Performance Standard – Rehab: Commercial, Nonprofit, Mixed-Use



- Applicable energy performance requirements in Air Barrier and Insulation Inspection Component Guide and Energy Performance Table for Criterion 5-1 were met.
- Slab insulation and pre-drywall thermal bypass inspection passed by a third-party energy rater or commissioning agent.
- Energy performance of Substantial Rehab project met or exceeded by  $\geq 10\%$  the current version of ASHRAE 90.1 as coordinated with the adopted edition of the IECC for the State of Iowa was achieved. Submitted to IEDA modeling information verifying exceeding by 10% the current version of ASHRAE 90.1 as coordinated with the adopted edition of the IECC for the State of Iowa.
- Energy performance of Moderate Rehab project met or exceeded the current version of ASHRAE 90.1 as coordinated with the adopted edition of the IECC for the State of Iowa was achieved. Submitted to IEDA modeling information verifying meeting the current version of ASHRAE 90.1 as coordinated with the adopted edition of the IECC for the State of Iowa.
- Building was commissioned by a third-party and the commissioning report submitted to IEDA.
- Completed and submitted the required Energy Review Form (only projects > 100,000 cu. Ft.)
- 5.2a, Moving to Zero Energy: Additional Reductions in Energy Use
  - Any additional reductions in energy use claimed in project application were achieved.
- 5.3, HVAC Sizing, Installation and Duct Systems
  - Residential Projects: Heating and cooling equipment sized in accordance with the Air Conditioning Contractors of America (ACCA) Manual, Parts D, J and S
  - Commercial Projects: ASHRAE handbooks, or equivalent software
- 5.4, ENERGY STAR Appliances (if providing appliances)
  - ENERGY STAR appliances were used throughout the project.
- 5.5, Lighting
  - Lighting requirements of criterion 5.8 were met.
- 7.3 Combustion Equipment
  - Power vented or direct-vent combustion appliance were utilized and combustion safety test completed for equipment not replaced.

To be Completed by Energy Rater/Energy Professional	
Signature:	
Name:	
Title:	
Tel. No.:	
E-mail:	
Accreditation: (license/licensing body)	
Date:	

A fillable PDF version of this form is available here:  
[iowaeda.com/userdocs/programs/AppxE-EnergyPerformanceCertificationForm.pdf](http://iowaeda.com/userdocs/programs/AppxE-EnergyPerformanceCertificationForm.pdf)



# APPENDIX F

## PROJECT PLAN AND SPEC BOOK CHECKLIST

A fillable PDF version of this form is available here:  
[iowaeda.com/userdocs/programs/AppxF-ProjPlanAndSpecBookChecklistForm.pdf](http://iowaeda.com/userdocs/programs/AppxF-ProjPlanAndSpecBookChecklistForm.pdf)

CRITERION	PROJECT PLANS	PAGE #	SPEC BOOK	PAGE #	ARCHITECT/ DESIGNER INITIALS
1.1 Project Priorities Survey					
1.2 Charrettes and Coordination Meetings					
1.3 Documentation of Criteria in Plans and Specs					
1.4 Construction Management					
1.5 Health and Well-Being: Health Action Plan					
1.6 Resilient Communities: Multi-Hazard Risk Assessment					
1.7 Resilient Communities: Strengthening Cultural Resilience					
1.8 Resilient Structures:					
2.1 Sensitive Site Protection					
2.2 Connections to Existing Development and Infrastructure					
2.3-4 Compact Development					
2.5 Proximity to Services and Community Resources					
2.6-7 Preservation of and Access to Open Space					
2.8 Access to Transit					
2.9 Improving Connectivity to the Community					
2.10 Passive Solar Heating/Cooling					
2.11 Adaptive Reuse of Buildings					
2.12 Access to Fresh, Local Foods					
2.13 Advanced Certification: Site Planning, Design & Mgmt.					
2.14 Local Economic Development and Community Wealth					
2.15a Access to Broadband: Broadband Ready					
2.15b Access to Broadband: Connectivity					
3.1 Environmental Remediation					
3.2 Minimization of Disturbance During Staging & Construction					
3.3 Ecosystem Services/Landscape					
3.4 Surface Water Management					
3.5 Surface Water Management Channel Protection Volume					
3.6-7 Efficient Irrigation & Water Reuse					
4.1 Water-Conserving Fixtures					
4.2 Advanced Water Conservation					
4.3 Water Quality					





CRITERION	PROJECT PLANS	PAGE #	SPEC BOOK	PAGE #	ARCHITECT/ DESIGNER INITIALS
4.4 Monitoring Water Consumption and Leaks					
4.5 Efficient Plumbing Layout and Design					
4.6 Non-Potable Water Reuse					
4.7 Access to Potable Water During Emergencies					
5.1 Building Performance Requirements					
5.1a–d Building Performance Standards					
5.2a Moving to Zero Energy: Additional Reductions in Energy					
5.2b Moving to Zero Energy: Near Zero Certification					
5.3a Moving to Zero Energy: PV/Solar Hot Water Ready					
5.3b Moving to Zero Energy: Renewable Energy					
5.4 Achieving Zero Energy					
5.5a Moving to Zero Carbon: All-Electric Ready					
5.5b Moving to Zero Carbon: All Electric					
5.6 Sizing Heating and Cooling Equipment					
5.7 ENERGY STAR Appliances					
5.8 Lighting					
5.9 Resilient Energy Systems: Floodproofing					
5.10 Resilient Energy Systems: Critical Loads					
5.11 Electric Vehicle Charging					
5.12 Advanced Framing and Resilient Design					
5.13 FORTIFIED Roofs and Homes					
6.1 Ingredient Transparency for Material Health					
6.2 Recycled Content and Ingredient Transparency					
6.3 Chemical Hazard Optimization					
6.4 Healthier Material Selection					
6.5 Environmentally Responsible Material Selection					
6.6 Bath, Kitchen, Laundry Services					
6.7 Regional Materials					
6.8 Managing Moisture: Foundations					
6.9 Managing Moisture: Roofing and Wall Systems					
6.10 Construction Waste Management					
6.11 Recycling Storage					
7.1 Radon					
7.2 Reduce Lead Hazards in Pre-1978 Buildings					
7.3 Combustion Equipment					
7.4 Garage Isolation					
7.5 Integrated Pest Management					



CRITERION	PROJECT PLANS	PAGE #	SPEC BOOK	PAGE #	ARCHITECT/ DESIGNER INITIALS
7.6 Smoke-Free Policy					
7.7 Ventilation					
7.8 Dehumidification					
7.9 Construction Pollution Management					
7.10 Noise Reduction					
7.11 Active Design: Promoting Physical Activity					
7.12 Beyond ADA: Universal Design					
7.13 Healing-Centered Design					
8.1 Building Operations & Maintenance Manual and Plan					
8.2 Emergency Management Manual					
8.3 Occupant Manual					
8.4 Walk-Throughs and Orientations to Property Operation					
8.5 Energy and Water Data Collection and Monitoring					

## APPENDIX G

### 2015 IECC CLIMATE ZONE MAP

#### AIR BARRIER AND INSULATION INSPECTION COMPONENT GUIDE

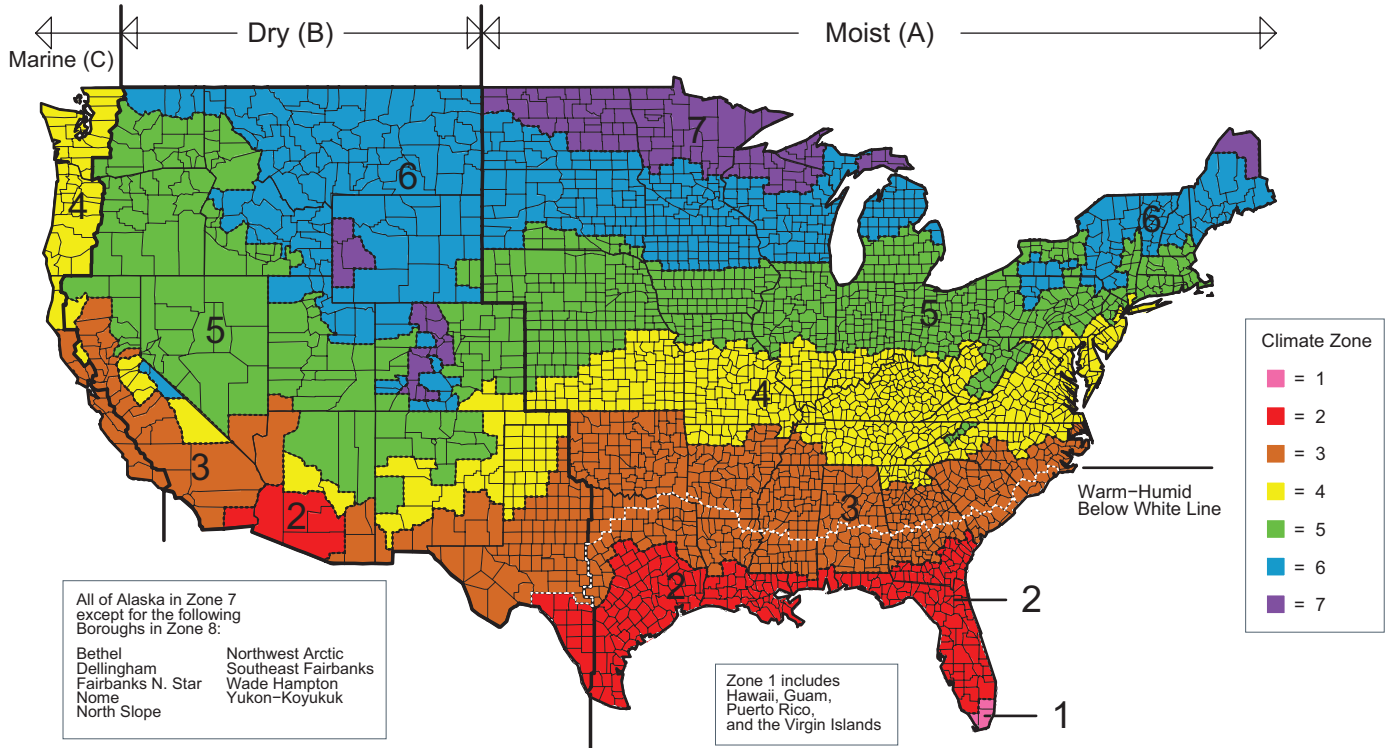



COMPONENT	CRITERIA
Air barrier and thermal barrier	<b>Exterior</b> thermal envelope insulation for framed walls is installed in substantial contact and continuous alignment with building envelope air barrier
	Breaks or joints in the air barrier are filled or repaired
	Air-permeable insulation is not used as a sealing material
Ceiling/attic	Air barrier in any dropped ceiling / soffit is substantially aligned with insulation and any gaps are sealed
	Attic access (except unvented attic), knee-wall door, or drop-down stair is insulated and sealed or in conditioned space
Walls	Corners and headers are insulated; junction of foundation and sill plate is sealed
Windows and doors	Space between window / door jambs and framing is sealed – No stuffing of fiberglass insulation is allowed
Rim joists	Rim joists are insulated and include an air barrier following included reference to best practice example
Floors (including above-garage cantilevered floors)	Insulation is installed to maintain permanent contact with the area it is insulating
	Air barrier is installed at any exposed edge of insulation
Crawl space walls	Insulation is permanently attached to walls. No poly or vinyl faced insulation. Follow included reference to best practice example
	Exposed earth in unvented crawl spaces is covered with Class I vapor barrier with overlapping joints taped
Shafts, penetrations	Duct shafts, utility penetrations, knee walls, and flue shafts opening to exterior or unconditioned spaces are sealed
Narrow cavities	Batts in narrow cavities are cut to fit, or narrow cavities are filled with sprayed / blown insulation. Narrow cavities are defined as 4 inches wide or less
Garage separation	Air sealing is provided between the garage and conditioned spaces and door assembly meets fire code.
Recessed lighting	Recessed light fixtures are airtight, ICAT rated, & sealed to drywall
	Exception — fixtures in conditioned space
Plumbing and wiring	Insulation is placed between the exterior wall and the pipes
	Batt insulation is cut to fit around wiring and plumbing, or sprayed / blown insulation extends behind piping and wiring
Shower / tub on exterior wall	Showers and tubs on exterior walls have insulation and an air barrier separating them from the exterior wall
Electrical / phone box	Air barrier extends behind boxes or air-sealed-type boxes are installed on exterior walls
Common wall	Air barrier is installed in common wall between dwelling units and air infiltration is treated like an exterior wall – common walls need to be considered as an exterior wall for air sealing
HVAC register boots	HVAC register boots that penetrate building envelope are sealed to subfloor or drywall
Fireplace	Fireplace walls include an air barrier

This document is intended solely to help graphically demonstrate the air leakage provisions of section 402.4 of the 2009 IECC. It does not cover all air sealing locations or techniques. Other code provisions may be applicable as well.

**NOTE: The R-values below are from an example prepared for the state of Georgia. Iowa projects must use as a minimum the R-values contained in the International Energy Conservation Code 2015 for climate zones 5 and 6.**



### AIR SEALING KEY POINTS

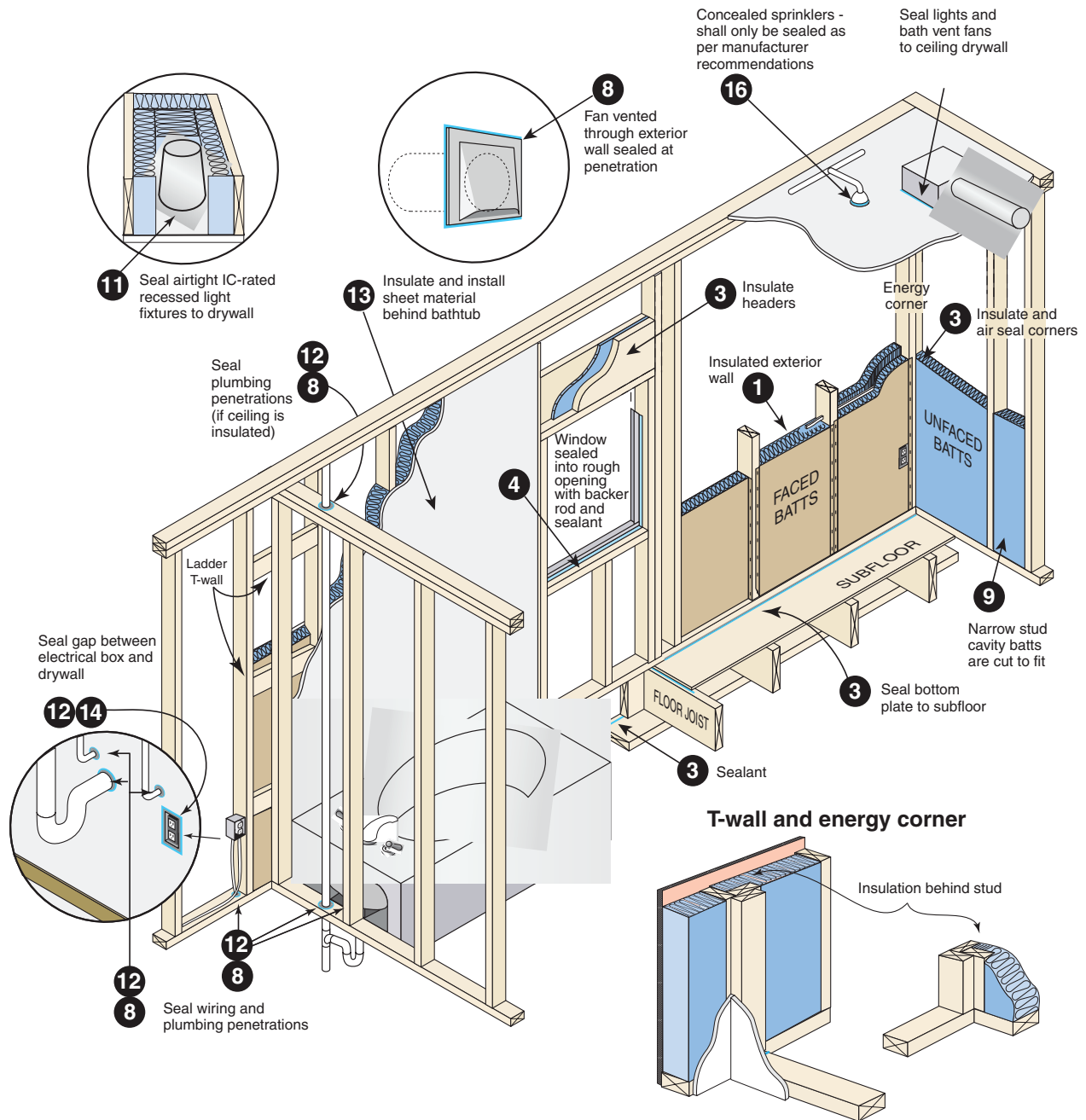

This document is intended solely to help graphically demonstrate the air leakage provisions of the 2015 IECC. It does not cover all air sealing location or techniques. Other code provisions may be applicable as well. *Image courtesy of Southface. Reprinted with permission.*



**AIR SEALING KEY POINTS (continued)**

**Chases and common by-passes**

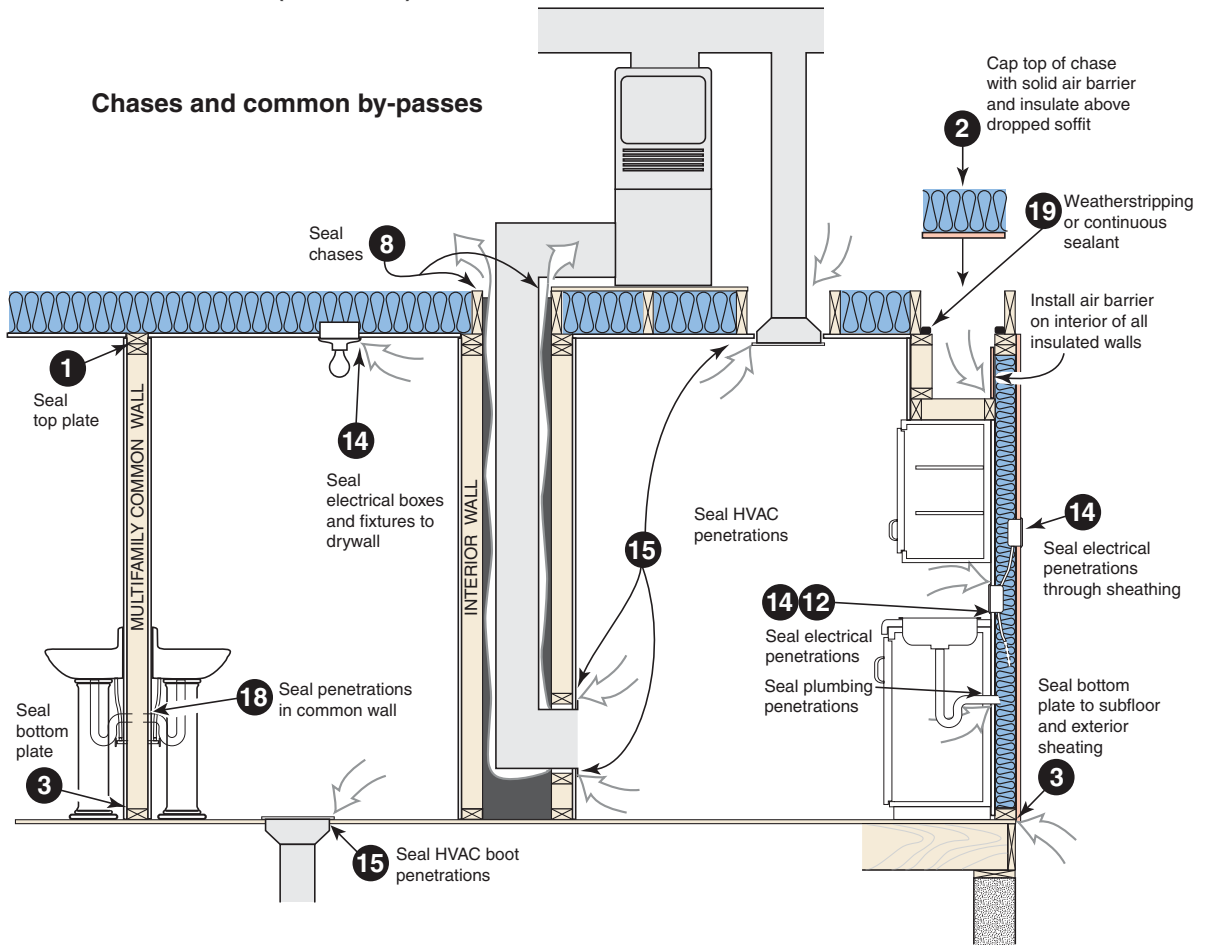

**Shower/tub drain rough opening**

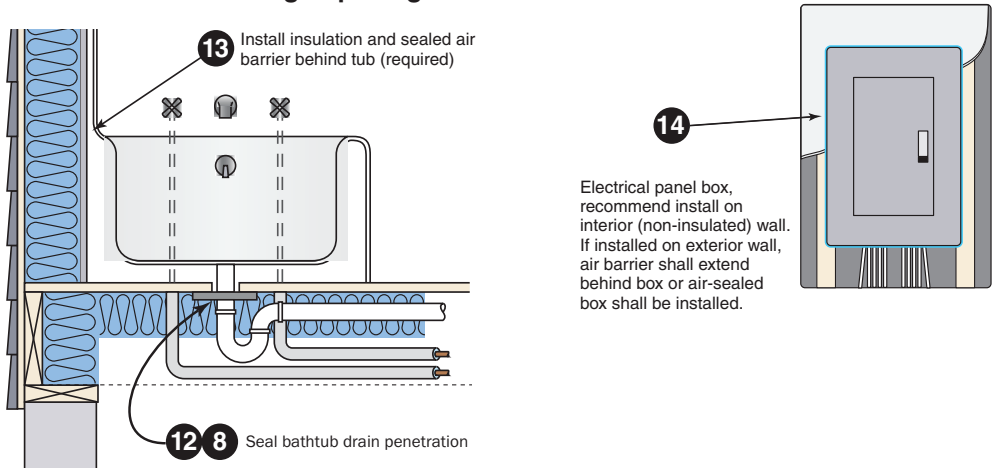

This document is intended solely to help graphically demonstrate the air leakage provisions of the 2015 IECC. It does not cover all air sealing location or techniques. Other code provisions may be applicable as well. *Image courtesy of Southface. Reprinted with permission.*



**AIR SEALING KEY POINTS (continued)**

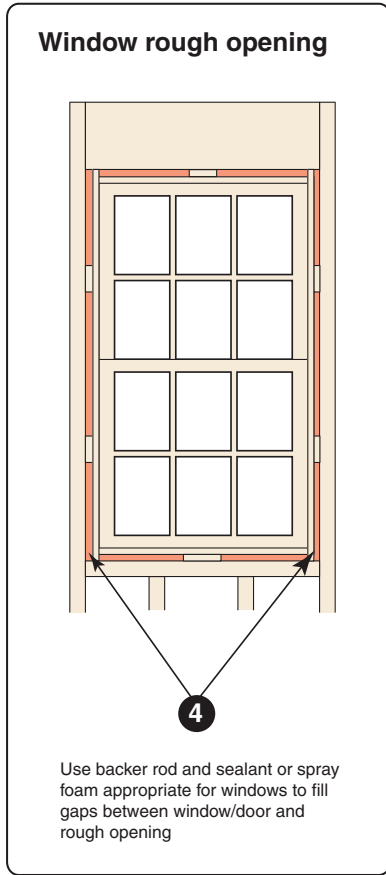

**Wall cross-section**

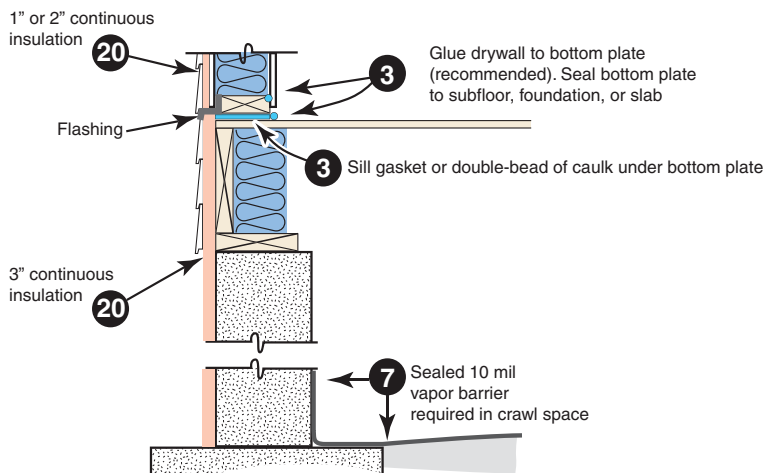
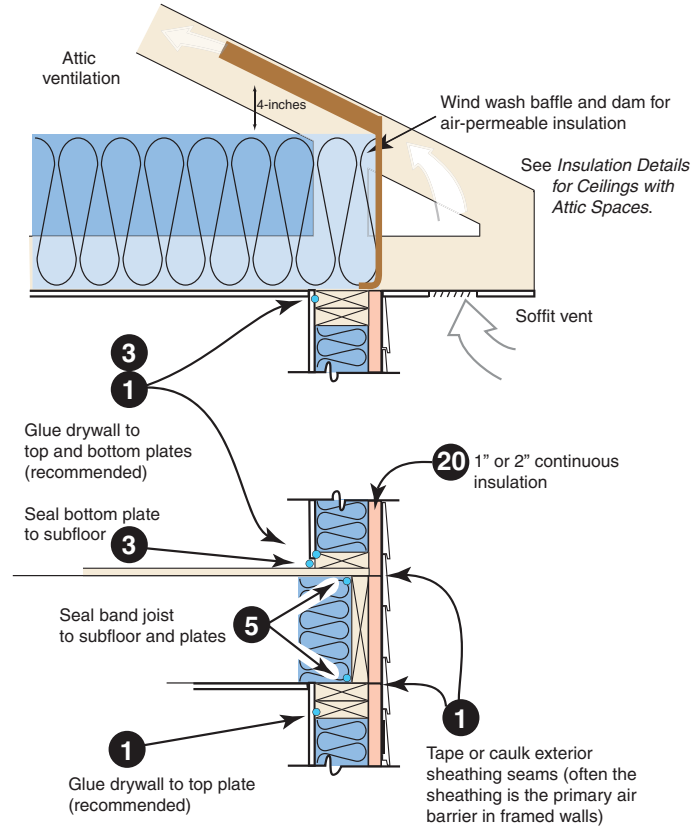

This document is intended solely to help graphically demonstrate the air leakage provisions of the 2015 IECC. It does not cover all air sealing location or techniques. Other code provisions may be applicable as well. *Image courtesy of Southface. Reprinted with permission.*



**AIR SEALING KEY POINTS (continued)**

**Combustion chase penetrations**

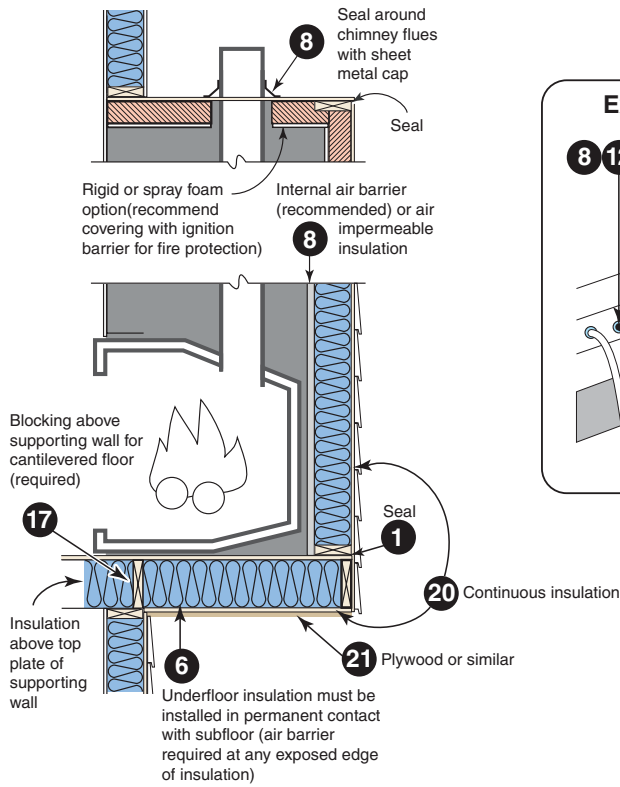

**Exterior penetrations**

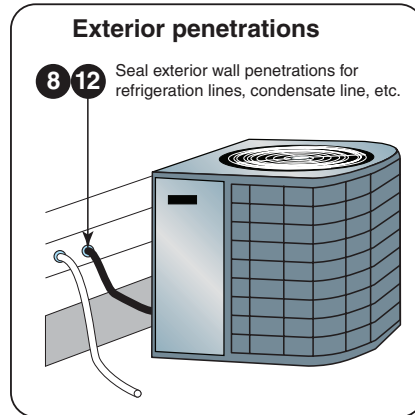

This document is intended solely to help graphically demonstrate the air leakage provisions of the 2015 IECC. It does not cover all air sealing location or techniques. Other code provisions may be applicable as well. *Image courtesy of Southface. Reprinted with permission.*





**AIR SEALING KEY POINTS (continued)**

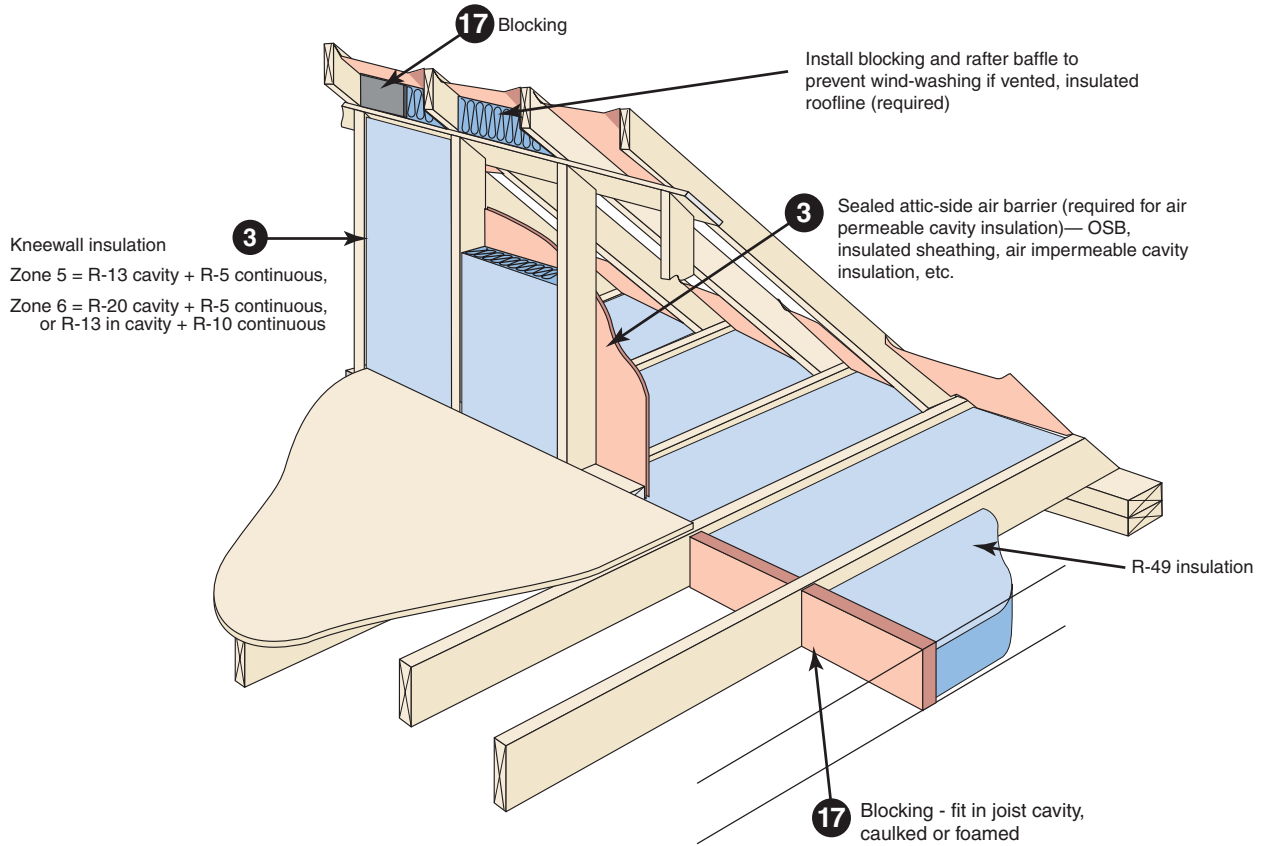

**Attic knee-walls**

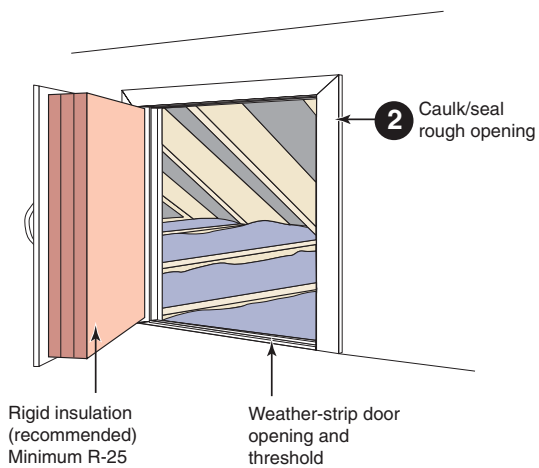

**Two-level attic**

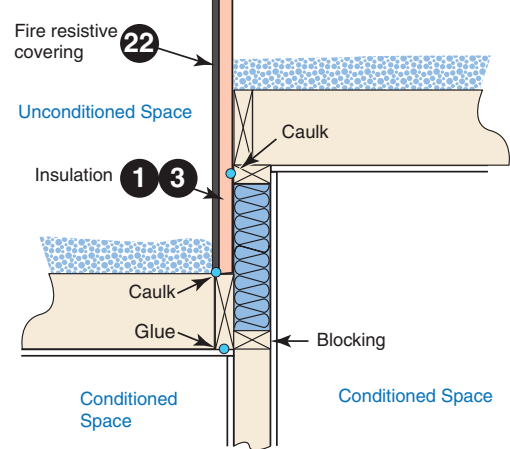

This document is intended solely to help graphically demonstrate the air leakage provisions of the 2015 IECC. It does not cover all air sealing location or techniques. Other code provisions may be applicable as well. *Image courtesy of Southface. Reprinted with permission.*



**AIR SEALING KEY POINTS (continued)**

**Attic scuttle**

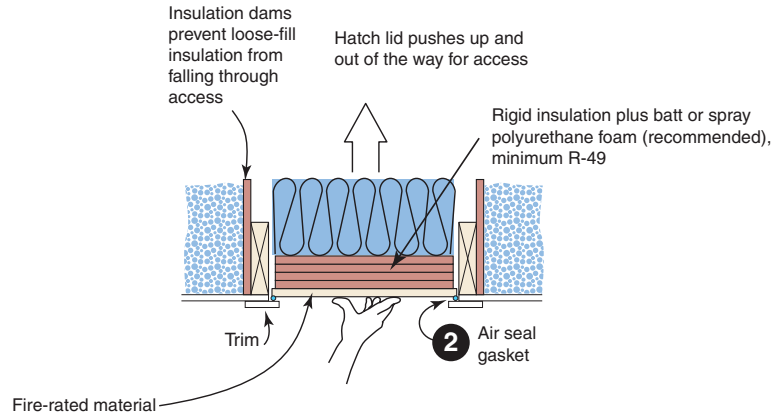

**Attic pull-down stairs**

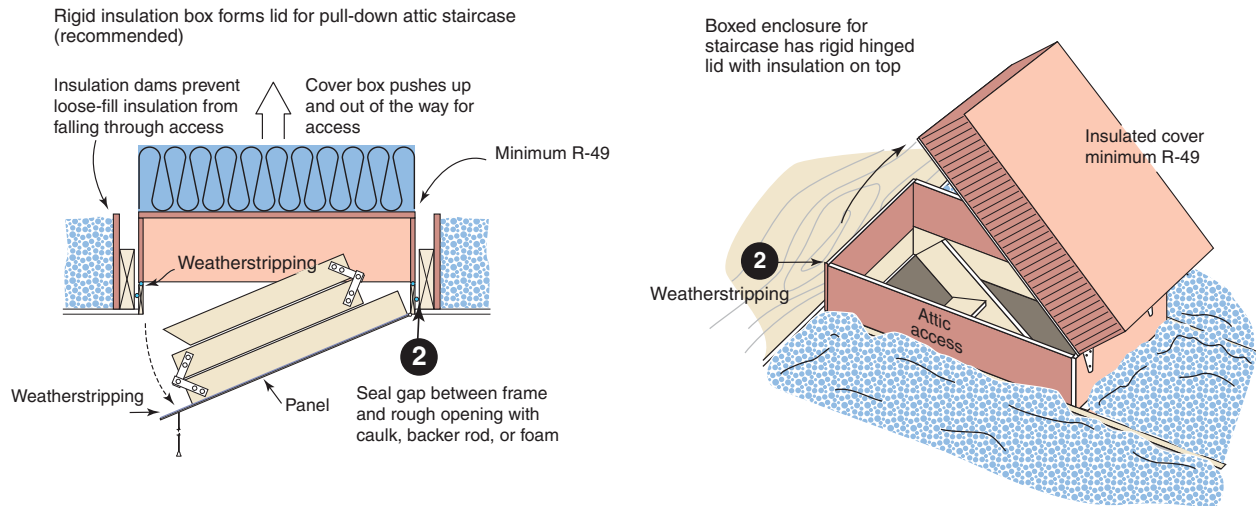

This document is intended solely to help graphically demonstrate the air leakage provisions of the 2015 IECC. It does not cover all air sealing location or techniques. Other code provisions may be applicable as well. *Image courtesy of Southface. Reprinted with permission.*



**AIR SEALING KEY POINTS (continued)**

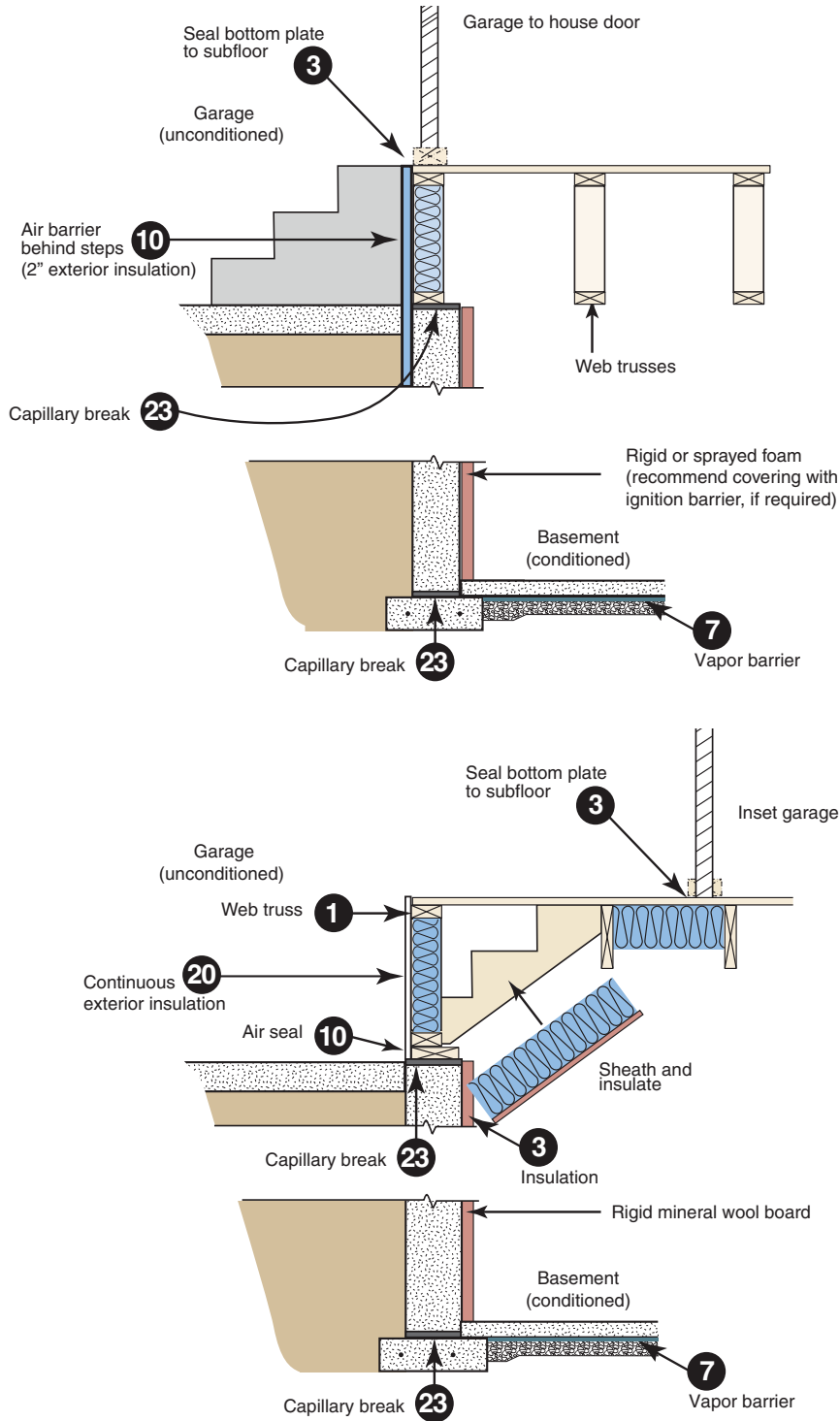

This document is intended solely to help graphically demonstrate the air leakage provisions of the 2015 IECC. It does not cover all air sealing location or techniques. Other code provisions may be applicable as well. *Image courtesy of Southface. Reprinted with permission.*



**AIR SEALING KEY POINTS (continued)**

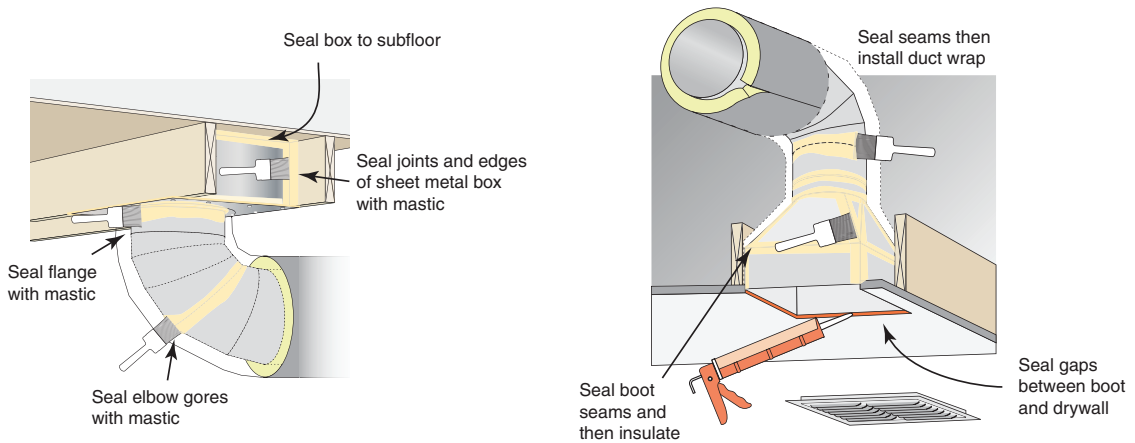
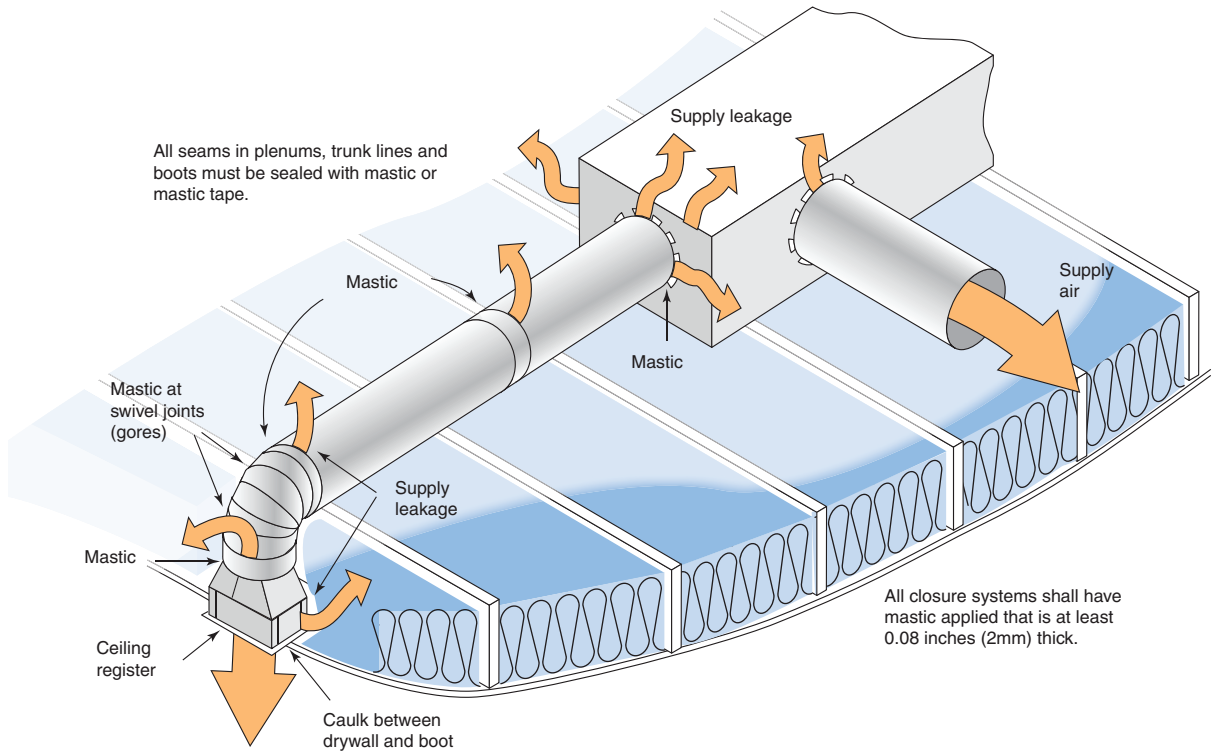

This document is intended solely to help graphically demonstrate the air leakage provisions of the 2015 IECC. It does not cover all air sealing location or techniques. Other code provisions may be applicable as well. *Image courtesy of Southface. Reprinted with permission.*



**AIR SEALING KEY POINTS (continued)**

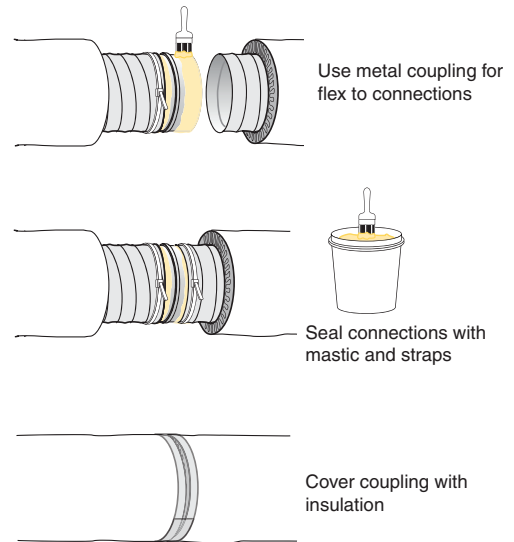
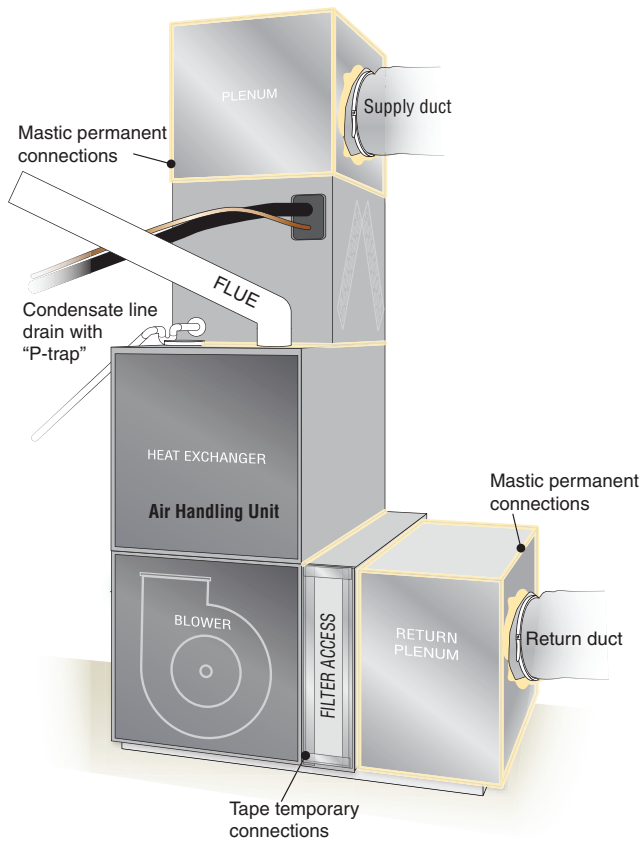
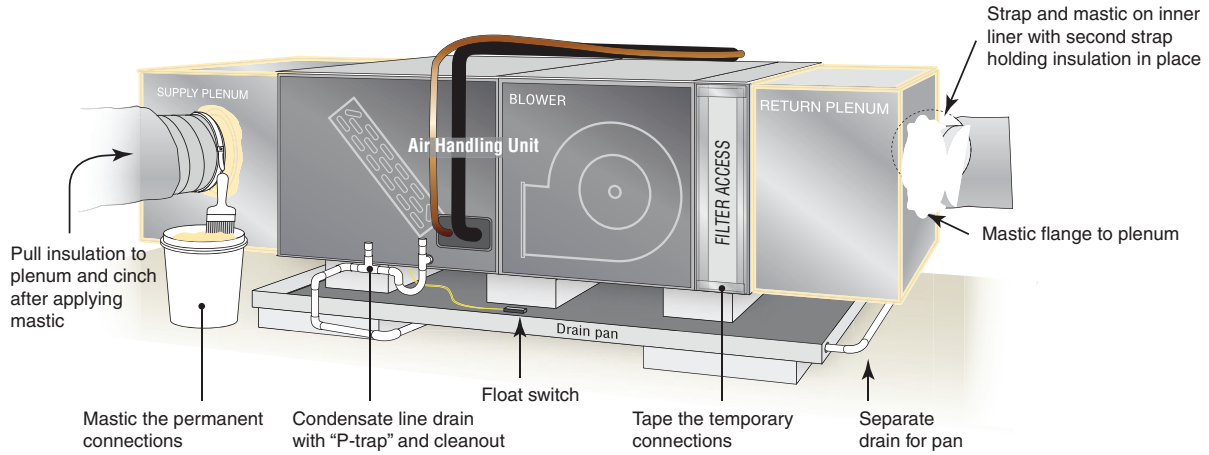

This document is intended solely to help graphically demonstrate the air leakage provisions of the 2015 IECC. It does not cover all air sealing location or techniques. Other code provisions may be applicable as well. *Image courtesy of Southface. Reprinted with permission.*



## AIR SEALING KEY POINTS (continued)

### Multifamily Air-sealing Details

- 8 Cap and seal all chases including chases for grouped utility lines and radon vents

*Seal penetrations in mechanical closet including penetrations for the:*

- 8 supply plenum
  - 8 outside air ventilation
  - 8 12 refrigerant line
  - 12 plumbing
  - 12 14 electrical
  - 12 gas fuel
- 5 Seal band area at exterior sheathing side and all penetrations through band
  - 1 3 UL-compliant air sealing at drywall finishing for any wall adjacent to stairwell or elevator. Air seal this gap at every change in floor level
  - 8 Seal miscellaneous clustered penetrations through building envelope (e.g. refrigerant lines)

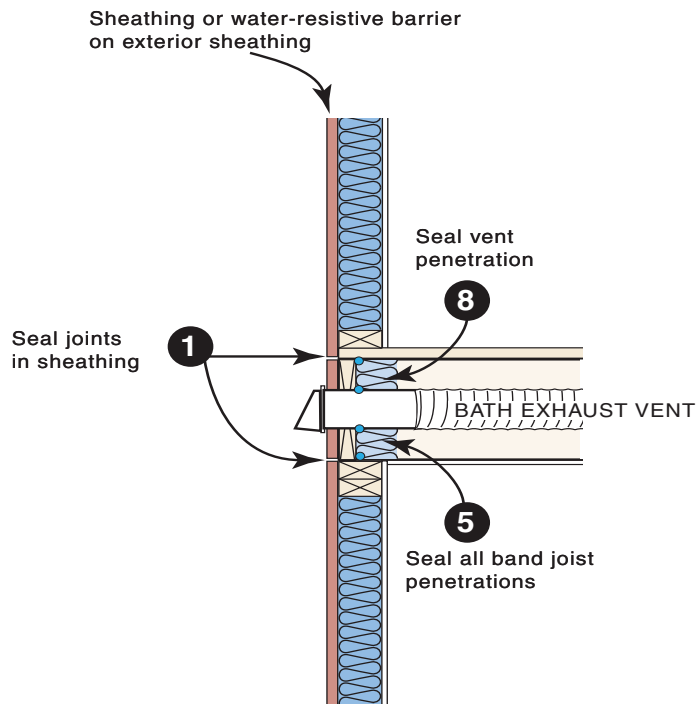

This document is intended solely to help graphically demonstrate the air leakage provisions of the 2015 IECC. It does not cover all air sealing location or techniques. Other code provisions may be applicable as well. *Image courtesy of Southface. Reprinted with permission.*



**AIR SEALING KEY POINTS (continued)**

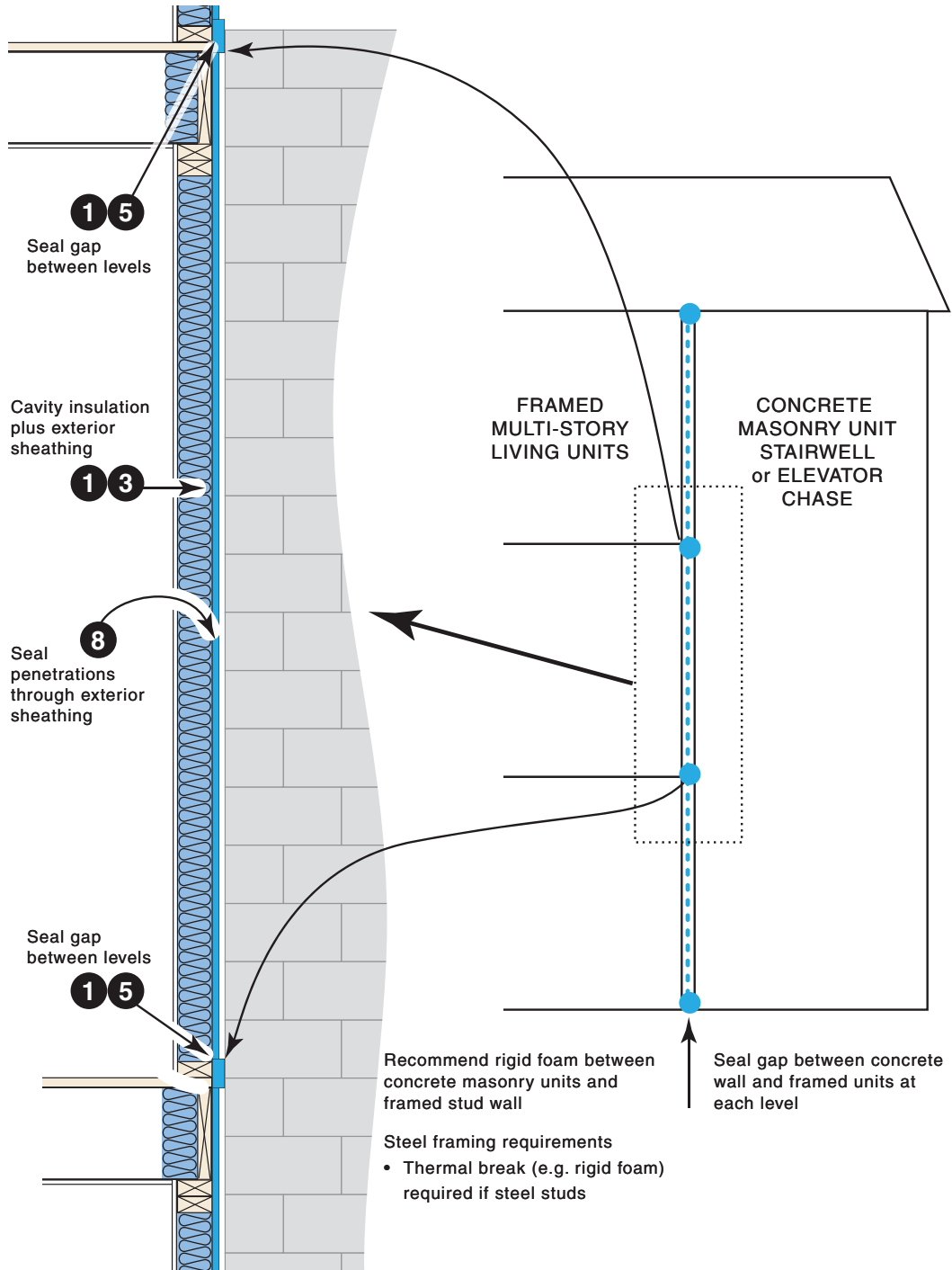

This document is intended solely to help graphically demonstrate the air leakage provisions of the 2015 IECC. It does not cover all air sealing location or techniques. Other code provisions may be applicable as well. *Image courtesy of Southface. Reprinted with permission.*



AIR SEALING KEY POINTS (continued)

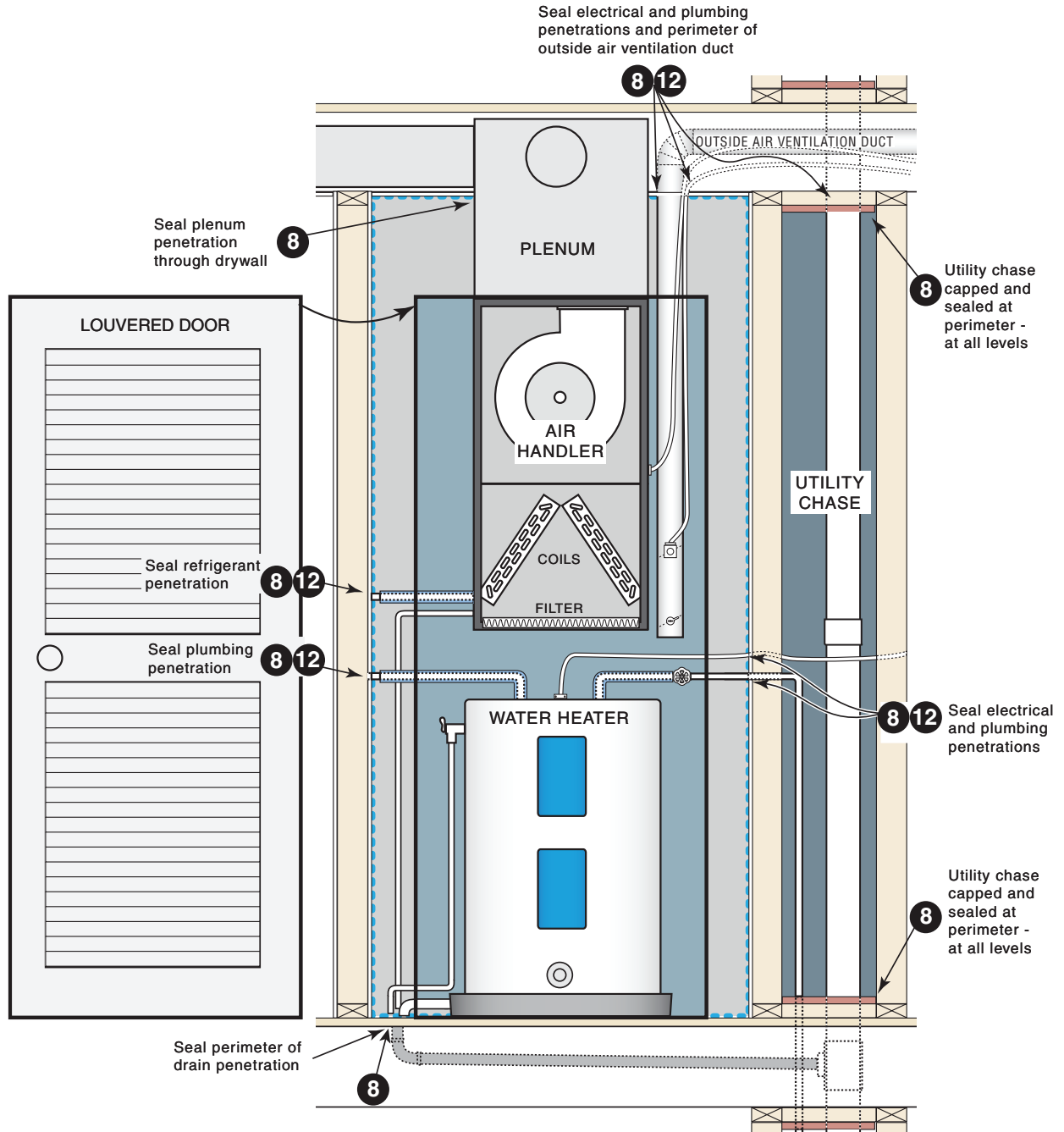

This document is intended solely to help graphically demonstrate the air leakage provisions of the 2015 IECC. It does not cover all air sealing location or techniques. Other code provisions may be applicable as well. *Image courtesy of Southface. Reprinted with permission.*





AIR SEALING KEY POINTS (continued)

# APPENDIX H

## INTEGRATED DESIGN AGENDA AND OUTCOMES

### TEMPLATE

**Building Thermal Envelope** — The basement walls, exterior walls, floor, roof, and any other building element that enclose conditioned space. This boundary also includes the boundary between conditioned space and any exempt or unconditioned space. —2015 IECC

The *building thermal envelope* is the barrier that separates the conditioned space from the outside or unconditioned spaces. The building envelope consists of two parts - an air barrier and a thermal barrier that must be both continuous and contiguous (touching each other). In a typical residence, the building envelope consists of the roof, walls, windows, doors, and foundation. Examples of unconditioned spaces include attics, vented crawlspaces, garages, and basements with ceiling insulation and no HVAC supply registers.

Example 1 – Prescriptive Compliance

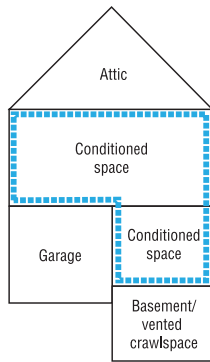

This is a conventional approach that likely locates all ductwork in unconditioned spaces.

*Prescriptive R-values*

- Flat ceiling: R-38
- Exterior walls: R-13
- Floor over garage and basement/crawl: R-19 (climate zones 3 & 4)
- Ductwork sealed with mastic and insulated to R-8 in attic, R-6 in basement/crawlspace
- Garage<sup>5</sup>, attic and basement/crawl are unconditioned spaces

Example 2 – Alternate Compliance

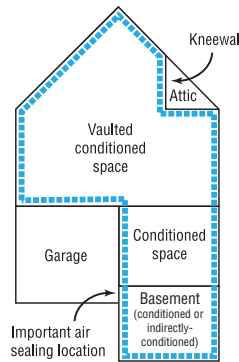

If supply registers deliver conditioned air to basement, it is considered conditioned. With no supply air, it is considered an indirectly-conditioned space.

*Example R-values<sup>1</sup>*

- Flat ceiling: R-38
- Knee walls: R-18 (required)<sup>2</sup> (R-13+ R-5, R-15 + R-3, R-19 in 2x6)
- Vaulted ceiling: R-20 air-permeable insulation plus R-5 rigid foam board<sup>3</sup>
- Exterior walls: R-13
- Basement masonry walls: R-5
- Basement slab: R-0<sup>4</sup>
- Ductwork sealed with mastic and insulated to R-8 in attic, R-6 in basement
- Garage<sup>5</sup> and attic are unconditioned spaces

Example 3 – Alternate Compliance

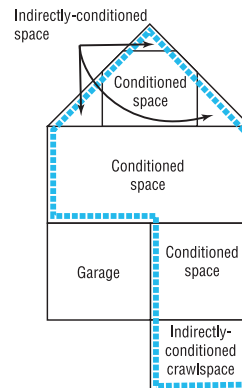

The top conditioned floor functions as a vaulted ceiling with interior walls although it appears to have kneewalls and a flat ceiling. An advantage of this approach is that all upstairs ductwork is located inside the building envelope.

The crawlspace walls are insulated and do not contain vents. The crawlspace ground is covered with 100% plastic and functions as a “mini-basement.”

*Example R-values<sup>1</sup>*

- Vaulted ceiling: R-20 air-impermeable foam insulation<sup>3</sup>
- Exterior walls: R-13 + R-5 sheathing
- Crawlspace walls: R-5
- Ductwork sealed with mastic and insulated to R-6
- Garage<sup>5</sup> is unconditioned space

1 R-values shown are examples and not necessarily prescriptive code requirements. Refer to the Georgia Energy Code for specific prescriptive insulation requirements.  
 2 An attic kneewall is any vertical wall that separates conditioned space from an unconditioned attic. In Georgia, kneewalls must be insulated to R-18. A sealed attic-side air barrier (OSB, foil-faced sheathing, etc.) is required when using air permeable insulation.  
 3 Requires trade-off since prescriptive ceiling requirement is R-38, see routine installed insulation options and section 806.4 of the 2006 IRC.  
 4 Slab insulation is not required in Georgia due to termite risk.  
 5 Although there is nothing to prevent the garage walls from being insulated, due to indoor air quality concerns, the garage should never be considered inside the building

This document is intended solely to help graphically demonstrate the air leakage provisions of the 2015 IECC. It does not cover all air sealing location or techniques. Other code provisions may be applicable as well. *Image courtesy of Southface. Reprinted with permission.*



**AIR SEALING KEY POINTS (continued)**

**Standard Truss with tapered insulation depth**

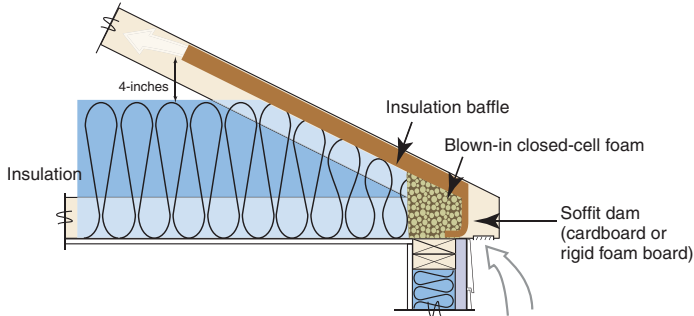

**Note: Wind wash baffle and air-permeable insulation dam.** For air permeable insulation in vented attics, baffles shall be installed adjacent to soffit and eave vents. A minimum of a 1-inch of space shall be provided between the insulation and the roof sheathing and at the location of the vent. The baffle shall extend over the top of the insulation inward until it is at least 4 inches vertically above the top of the insulation. Any solid material such as cardboard or thin insulating sheathing shall be permissible as the baffle.

**Energy Truss with full height insulation (recommended)**

**NOTE:**  
R-38 complete coverage is deemed equivalent to prescriptive R-49

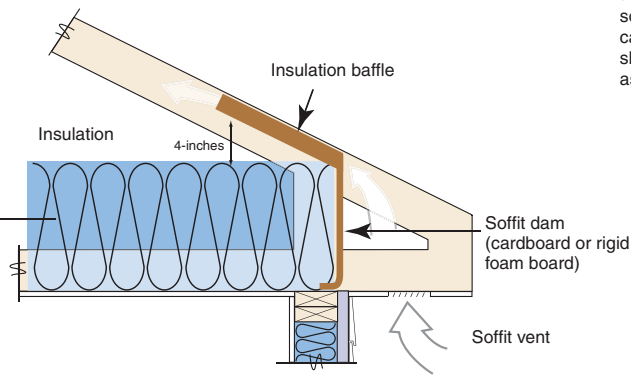

**Standard rafter and top plate with tapered insulation depth**

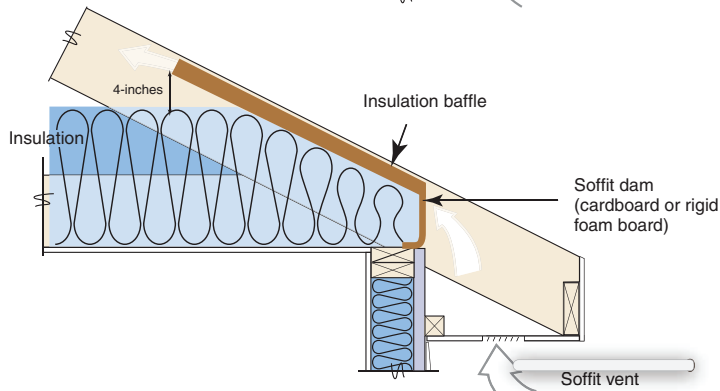

**Rafter on raised top plate with full height insulation (recommended)**

**NOTE:**  
R-38 complete coverage is deemed equivalent to prescriptive R-49

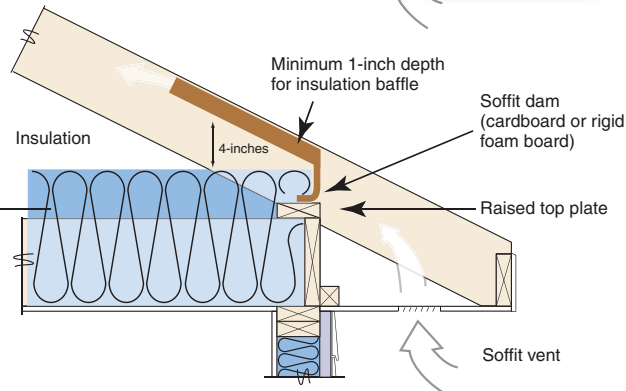

This document is intended solely to help graphically demonstrate the air leakage provisions of the 2015 IECC. It does not cover all air sealing location or techniques. Other code provisions may be applicable as well. *Image courtesy of Southface. Reprinted with permission.*



## AIR SEALING KEY POINTS (continued)

**Wall and ceiling** insulation that makes up portions of the building thermal envelope shall be installed to Passing Grade quality.

Two criteria affect installed insulation grading: **voids/ gaps** (in which no insulation is present in a portion of the overall insulated surface) and **compression/incomplete fill** (in which the insulation does not fully fill out or extend to the desired depth).

### Voids/Gaps

- Voids or gaps in the insulation are < 1% of overall component surface area (only occasional and very small gaps allowed for Passing Grade)

### Compression/Incomplete Fill

- Compression/Incomplete Fill for both *air permeable insulation* (e.g., fiberglass, cellulose) and *air impermeable insulation* (e.g., spray polyurethane foam) must be less than 1 inch in depth or less than 30% of the intended depth, whichever is more stringent. The allowable area of compression/incomplete fill must be less than 2% of the overall insulated surface to achieve a Passing Grade.
- Any compression/incomplete fill with a **depth** greater than the above specifications (up to 1" or 30% of the intended depth, whichever is more stringent) shall not achieve a Passing Grade.

### Additional Wall Insulation Requirements

- All vertical air permeable insulation shall be installed in substantial contact with an air barrier on all six (6) sides. **Exception:** Unfinished basements, rim/band joist cavity insulation and fireplaces (insulation shall be restrained to stay in place). For unfinished basements, air permeable insulation and associated framing in a framed cavity wall shall be installed less than 1/4" from the basement wall surface.
- Attic kneewall details – Attic kneewalls shall be insulated to a total R-value in Zone 5 of R-13 cavity + R-5 continuous and in Zone 6 of R-20 cavity + R-5 continuous, or R-13 in cavity + R-10 continuous insulation. Air permeable insulation shall be installed with a fully sealed attic-side air barrier (e.g., OSB with seams caulked, rigid insulation with joints taped, etc.). Attic kneewalls with air impermeable insulation shall not require an additional attic-side air barrier.

**Underfloor insulation** that makes up portions of the building thermal envelope shall be installed to Passing Grade quality.

Two criteria affect installed insulation grading: **voids/ gaps** (in which no insulation is present in a portion of the overall insulated surface) and **compression/incomplete fill** (in which the insulation does not fully fill out or extend to the desired depth).

### Voids/Gaps

- Voids or gaps in the insulation are minimal for Passing Grade (< 2% of overall component surface area)

### Compression/Incomplete Fill

- Compression/Incomplete Fill for both *air permeable insulation* (e.g., fiberglass, cellulose) and *air impermeable insulation* (e.g., spray polyurethane foam) must be less than 1 inch in depth or less than 30% of the intended depth, whichever is more stringent. The allowable area of compression/incomplete fill must be less than 10% of the overall insulated surface to achieve a Passing Grade.
- Any compression/incomplete fill with a **depth** greater than the above specifications (up to 1" or 30% of the intended depth, whichever is more stringent) shall not achieve a Passing Grade.
- Air-permeable underfloor insulation shall be permanently installed against the subfloor decking. Adequate insulation supports (e.g., wire staves) for air permeable insulation shall be installed at least every 18-24". **Exception:** The floor framing-cavity insulation shall be permitted to be in contact with the topside of sheathing or continuous insulation installed on the bottom side of floor framing where combined with insulation that meets or exceeds the minimum wood frame wall R-value and that extends from the bottom to the top of all perimeter floor framing members

This document is intended solely to help graphically demonstrate the air leakage provisions of the 2015 IECC. It does not cover all air sealing location or techniques. Other code provisions may be applicable as well. *Image courtesy of Southface. Reprinted with permission.*



AIR SEALING KEY POINTS (continued)

Voids / Gaps

*Passing Grade*

Insulation is notched and completely surrounds electrical box

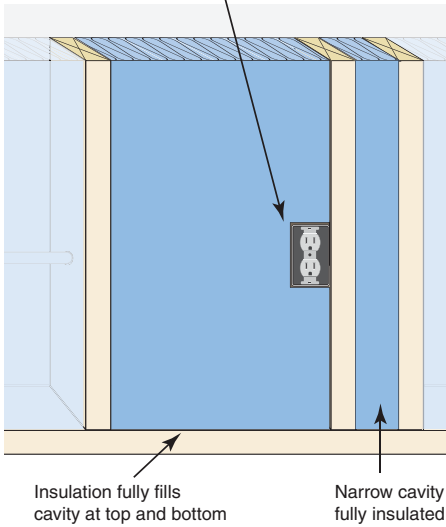

*Unacceptable Installation*

Incomplete insulation coverage around electrical box

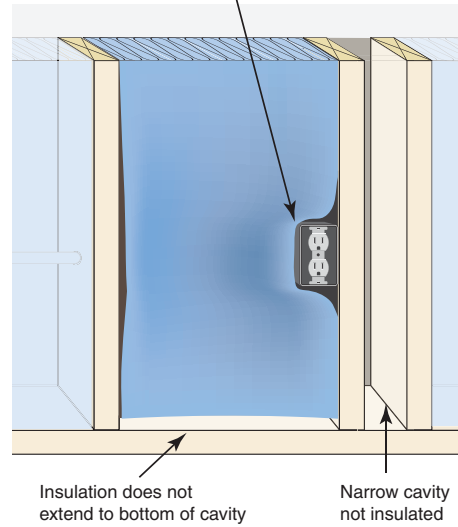

Compression / Incomplete Fill

*Passing Grade*

Insulation is slit around electrical wire

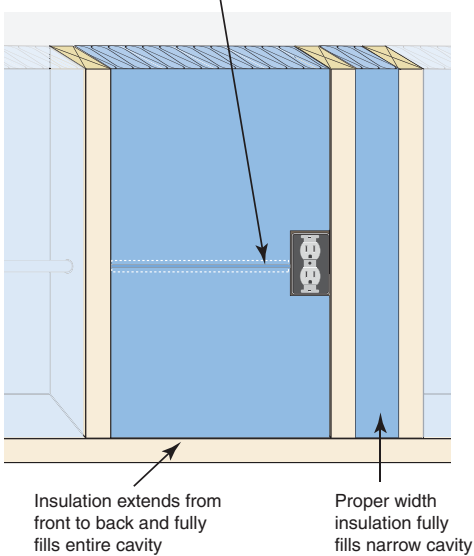

*Unacceptable Installation*

Insulation is compressed behind electrical wire

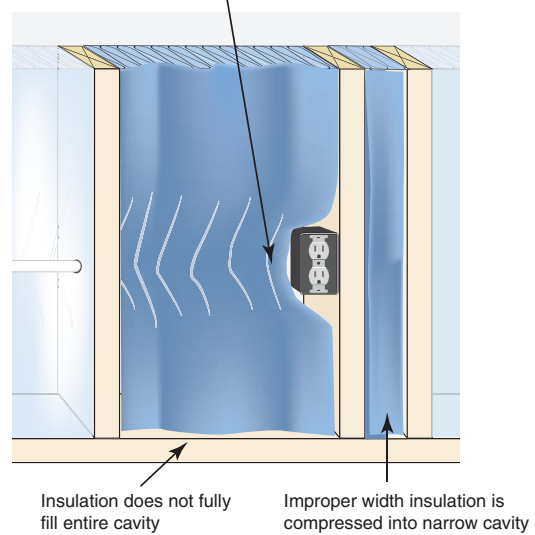

This document is intended solely to help graphically demonstrate the air leakage provisions of the 2015 IECC. It does not cover all air sealing location or techniques. Other code provisions may be applicable as well. *Image courtesy of Southface. Reprinted with permission.*



**AIR SEALING KEY POINTS (continued)**

*Passing Grade*

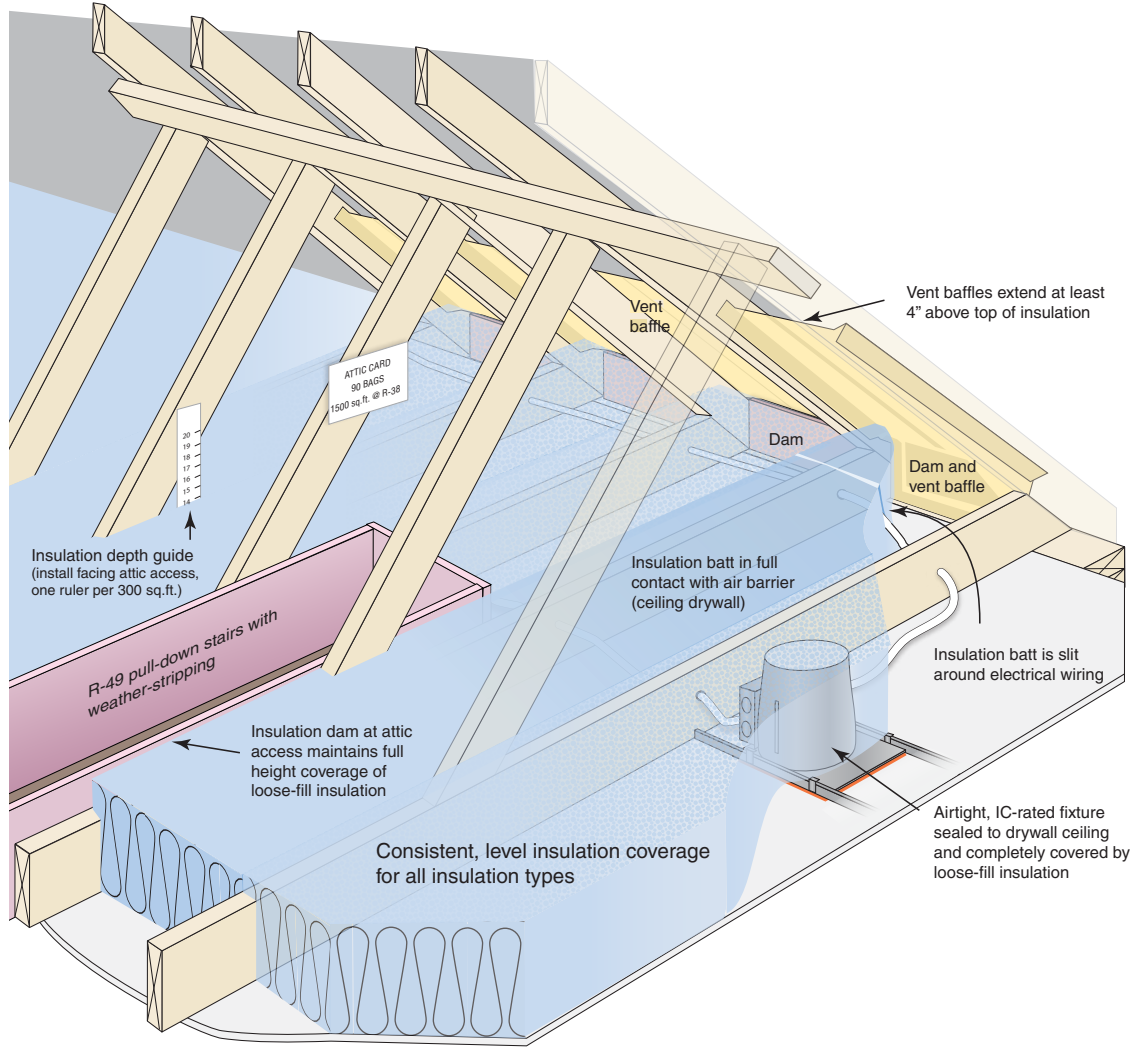

This document is intended solely to help graphically demonstrate the air leakage provisions of the 2015 IECC. It does not cover all air sealing location or techniques. Other code provisions may be applicable as well. *Image courtesy of Southface. Reprinted with permission.*



**AIR SEALING KEY POINTS (continued)**

*Passing Grade*

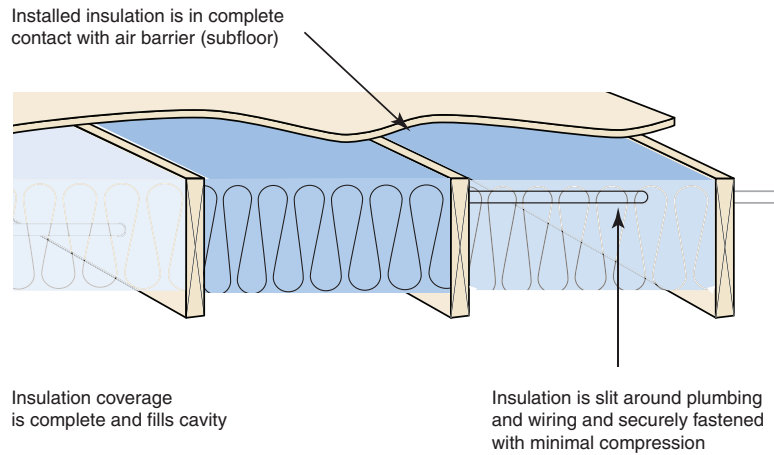

*Unacceptable Installation*

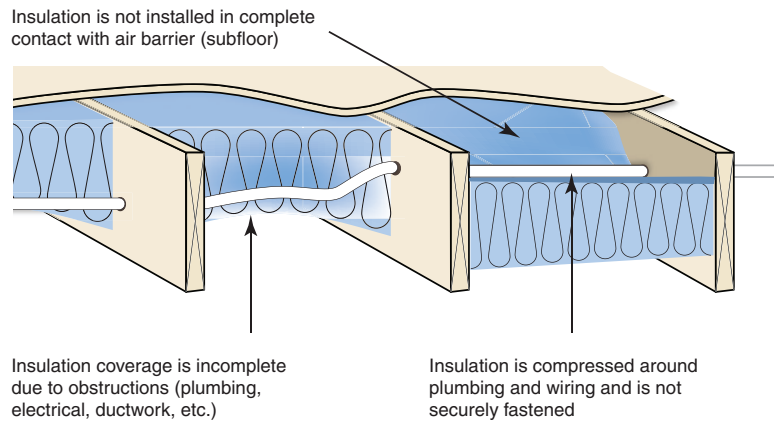

This document is intended solely to help graphically demonstrate the air leakage provisions of the 2015 IECC. It does not cover all air sealing location or techniques. Other code provisions may be applicable as well. *Image courtesy of Southface. Reprinted with permission.*



---

Enterprise Community Partners has developed a Green Charrette toolkit that is a tremendous resource in helping your project achieve high performance building outcomes. Provided below are an example green goals design charrette sample agenda as well as an example design charrette outcome template. For more integrated design resources, please visit [www.enterprisecommunity.org/solutions-and-innovation/green-communities/tools-and-services/charrette-toolkit](http://www.enterprisecommunity.org/solutions-and-innovation/green-communities/tools-and-services/charrette-toolkit).

### **Green Communities Goal-Setting Charrette Agenda (Sample)**

Project Name



Date of Charrette

**NOTES TO FACILITATOR:**

*Including this description as in introductory “one-pager” at the front end of the agenda can be helpful to those unfamiliar with charrettes. It should be noted that a primary role of the facilitator is time management, so the times indicated in this agenda are intended to assist in keeping activities on schedule. The order of this agenda can be changed, if needed, depending on the group.*

**Charrette Objectives:**

1. Gain an understanding of the process required to realize Green Communities goals.
2. Establish preliminary performance goals.
3. Familiarize participants with the importance of this approach.
4. Establish next steps.

**Charrette Agenda:**

Location of Charrette

Date of Charrette

Time of Charrette (for example: 9:00am – 5:00pm)

8:30 Welcome/Introductions

- a. Introduction of participants

**NOTES TO FACILITATOR:**

*Facilitator /Host will do brief welcome, then circle around the room so each individual can introduce themselves. Format will depend on number of participants, but each participant should state their name, discipline, role on project, and what they are looking to get out of the charrette / main questions they have.*

- b. Overview of the day and anticipated outcomes for the charrette

**NOTES TO FACILITATOR:**

*Facilitator will review the Agenda and format for the day’s events, including Ground Rules and Logistics (bathroom location, cell phones off, lunch/breaks, etc.). This brief overview should introduce the concept of “Co-Learning” (there are no experts) and Discovery (question assumptions) in order to set the tone for the day. Also, anticipated outcomes should be identified. This can take the form of a brief set of comments in most circumstances; for charrettes longer than one day, this can become a facilitated discussion, or a brainstorming exercise in the form of soliciting responses from attendees and recording them on flip charts.*

8:45 Integrative Design Overview

- a. Introduction to integrative design
- b. Case study examples





## NOTES TO FACILITATOR:

*How this educational Power Point is presented should be adjusted to the group's level of green building knowledge, but it should focus on the integrative process as the key to producing high performance green buildings within budget; accordingly, it is important to become very familiar with the examples, concepts, and principles.*

9:45 Touchstones Exercise – alignment around goals

- a. Brainstorm goals and guiding principles
- b. Prioritize key issues to address, then integrate

## NOTES TO FACILITATOR:

*This exercise is facilitated with the entire group. Please see the description of the Touchstones Exercise in the “Facilitators Guide”, and carefully review the “Guidance for Facilitating the Touchstones Exercise” document in order to implement this exercise accordingly.*

10:25 Break

10:40 Green Communities

- a. Introduction to Green Communities Criteria & requirements
- b. Case study examples

## NOTES TO FACILITATOR:

*This educational Power Point presentation is intended to provide only an overview of the structure of the Green Communities Criteria. The brief presentation will be followed by a few examples of integrative strategies that address multiple criteria. This section concludes with 4 case studies that are intended to be presented very quickly, simply to reinforce that this can and has been done for dozens of projects across the country.*

11:40 Project Parameters Overview

- a. Presentation of project status
- b. Review of pre-charrette research and analysis

## NOTES TO FACILITATOR:

*Before the Charrette, obtain from the project team a site plan to insert into the Power Point presentation (Project Parameters Overview slide) or insert a Google Earth aerial photo of the site to project on the screen while the project team presents project issues and status. This presentation should be very brief, so allow 20 minutes for the Client and design team to present their primary concerns and any specific parameters, constraints, opportunities, etc. – particularly specific site issues that the team will need to address during the breakout sessions. Be sure to remind the presenters that their presentation is to be kept brief and “to-the-point”.*

12:00 Lunch

12:45 Review Touchstones Exercise results – identify interrelationships

## NOTES TO FACILITATOR:



*Again, please see the description of the Touchstones Exercise in the “Facilitators Guide”, and review the results of the Exercise as described in the “Guidance for Facilitating the Touchstones Exercise” document by identifying interrelationships accordingly.*

1:00 Breakout Group Exercise – identify potential strategies

a. Focused small group sessions to explore specific design strategies regarding:

1. Site Issues
2. Building Issues
3. Operations Issues

NOTES TO FACILITATOR:

*Exercises should take part in groups of 5-7 people, depending upon the overall group size, to allow for everyone to be involved. Try to compose the small groups with participants from a variety of backgrounds / experience in order to gain a diverse set of opinions and perspectives from each breakout team. Please see the description of the Breakout Group Exercise in the “Facilitators Guide”, and carefully review the “Guidance for Facilitating Breakout Groups” document in order to implement this exercise accordingly.*

2:15 Integrate Findings from Breakouts – alignment around strategies

- a. Report results from small group breakout sessions to larger group
- b. Identify key integrated strategies
- c. Record what to keep and what to avoid

NOTES TO FACILITATOR:

*Assuming three breakout groups, each should be given 20 minutes to present their findings and answer questions from the other participants, while the facilitator records salient points on flip charts. Then facilitate a 20-30 minute discussion on finding synergies between the 3 group’s findings and record key points on flip charts. This discussion should be focused on targeting holistic solutions. Consider budget, environmental efficacy, performance goals, achievability, touchstones, and project mission. It also is helpful to generate a discussion that identifies “What to Keep” and “What to Avoid” from the small group’s ideas, and again, record the results on flip charts. Be sure to have someone photograph the flip charts and any accompanying sketches, so that these can be transcribed for inclusion in a charrette report.*

3:45 Break

4:00 Review Green Communities Criteria

- a. Initial pass at scorecard status



#### NOTES TO FACILITATOR:

*The Green Communities checklist can either play a central role in the charrette or it can take a back seat to other discussions. For example, if a team is able to have a productive conversation around massing, passive design, energy, daylight, ventilation, etc. then it may make sense to NOT focus on the Checklist. In these instances, it is useful to have someone keep track of the scorecard in the background during the day, and use it as a backstop to make sure there aren't any items that are relevant for a given design phase that the team may be overlooking (e.g. mold protection). For other projects where the level of experience with green building is minimal, or the team may not be comfortable conducting holistic conversations about the building design, then the Checklist can serve as a great way to frame the conversation by simply going through each Baseline requirement and credit and allowing discussion around each criterion. In the case of a one-day charrette, use this 75-minute period to review the most critical criteria and Baseline requirements.*

5:15 Next Steps

#### NOTES TO FACILITATOR:

*Facilitate a discussion around key next steps that need to occur by identifying schedule and responsibilities for these primary tasks, and record the results on flip charts. See also the "Next Steps" section of the "Facilitators Guide".*

5:30 Adjourn – Post-Charrette Activity (social, happy hour, etc.)

#### **Design Brief Outline**

*The following outline will help you work through the five major focus areas of a design brief; description of the project, developer's expectations, project vision, project size, and design considerations.*

#### **I. Description of the Project**



Provide design teams with a basic description of the project, including:

- Name
- Site address
- Type of project (new construction, rehab, adaptive reuse, etc.)
- Size and existing condition of site
- Basic nature of surrounding community
- Anticipated basic programming of site (affordable housing, mixed use, commercial, etc.)

*The Pre-Dev Team should also include a reference map to help design team's geo-locate the project, as well as a site map so that they understand the geometries and boundary conditions of the site.*

## II. Developer's Expectations

This section is an opportunity to communicate your mission and overarching goals with teams who may not be familiar with your organization, and contextualize this project as an important component of realizing those overall goals and aspirations. Provide teams with some basic context about past development experiences, and how you see this project building upon those experiences.

## III. Project Vision

In this section, highlight your most important priorities for the project, which may include but are not limited to:

- Resident health, comfort and experience
- Durability and maintainability
- Beauty/art
- Cost effectiveness
- Sustainability and performance
- Community building
- Neighborhood impact

These are all important aspects of your project, but if too many priorities are included in this section, design teams may not get a true understanding of what is most important to you. In this section, be specific about which priorities are pivotal to making this project a success.

## IV. Project Size

Provide information about your expectations related to the size of the building, including information on number of units / bedrooms and square footage. Indicate if these are flexible or fixed, based on financing assumptions.

## V. Design Considerations

This section should provide more in-depth information related to the regulatory parameters, programming and design goals of the project. It should provide the design teams with guidance but not be proscriptive. The goal is to set a foundation upon which the design teams can be creative and innovative. Encourage design teams to be thoughtful about these parameters and identify areas where design criteria potentially conflict, and be prepared to discuss how conflicts will be negotiated.

**Zoning and Regulatory Considerations** Provide any known zoning information, such as zoning district, available FAR, parking requirements, building type for code purposes.

**Site Considerations and Neighborhood Context** Provide information related to any special site or neighborhood features or considerations that should be accounted for, such as:



- Contamination
- Grading
- Desirable or undesirable adjacent parcels and building uses
- Access restrictions or requirements – pedestrian and vehicular
- Parking requirements
- Goals around activation of/use of street front
- Privacy goals
- Goals for exterior spaces and landscaping
- Neighborhood beautification goals
- Site-related maintenance goals
- Safety considerations
- Eco-districts
- Neighborhood and/or city-wide initiatives

### **Building Design Considerations**

What do you want the building to look like? What do other buildings in the neighborhood look like (height, width, location on lot, interesting features)? Is it important that this project look like the other buildings in the neighborhood, or should it stand out? In what ways?

What are some adjectives related to how you want people to feel when they pass by or walk around outside the building? What are adjectives related to how you want residents to feel when they travel through the common areas of the building?

### **Unit Design Considerations**

Provide the design team information related to your goals around unit design.

- Are there regulatory requirements for unit sizes that should be considered?
- Is unit layout flexibility important?
- What are your expectations and goals around finishes?
- Reference and include the information developed from the Project Program Guide related to your target population and their unit-based needs to complete this section.

### **Additional Program Requirements**

This section is intended to build upon the programming information in the project description sections above. Provide any relevant information developed from the Project Program Guide which was not included already, such as :

- Required space for on-site services
- Interior and exterior community- based spaces
- Operations and maintenance related spaces
- Commercial spaces

### **Greening Considerations**

It is important that expectations related to building performance are established at the RFP phase. We recommend including specific information related to the following sustainability-oriented items:

Greening Requirements – Are there regulatory and/or financing requirements related to green performance



building? If so, what are they?

Utility Rebate Programs –Do you expect teams to design to standards that will enable a project to achieve efficiency rebates from relevant utility companies?

Certifications – Is certification under a rating system expected? Should the project be designed as “certifiable”? What rating system do you expect people to design towards (Green Communities, LEED, ENERGY STAR, Passive House, etc.)

Renewable Energy – Do you expect the project to include renewable energy in the base building design? If not, should the project be designed as “solar ready” should funding become available in the future?

Systems Approach- What level of design/system complexity is acceptable to achieve performance and sustainability? What is the capacity of your maintenance team?

Energy Performance Goals- Do you have specific goals around how much energy/water the building will consume? Do you have specific goals around how tightly the building is air sealed? Can you provide specific metrics related to these goals (for example, how much water the building should consume in gallons per bedroom per day)?

### Health Considerations

Are there specific goals related to how the building design promotes resident health?

- How important is your building design to physical activity? Indoors? Outdoors? Seasonal or all year?
- Should the design team follow any healthy living design standards, such as the Active Design Guidelines? ([centerforactivedesign.org/guidelines](http://centerforactivedesign.org/guidelines))
- What standards do you have around healthy materials selection?
- Are there environmental hazards that the building and its systems need to mitigate (air quality, radon, etc.)?

### Universal Design Considerations

Outline your goals and requirements related to building and site accessibility by users of varying ages and physical/mental abilities. Be sure to focus on any particular needs that the population in your building has, as well as your broader goals related to designing a building that can serve the greatest range of users possible. Be sure to include that teams are responsible for ensuring that the project design meets all local, state, and federal requirements related to accessibility.

For more information on Universal Design visit the Green Communities website:

[www.EnterpriseCommunity.org/green](http://www.EnterpriseCommunity.org/green)

### Resilience

What are your goals around passive survivability in the case of an emergency when power is not available? Are active backup systems required/desirable?

### Construction Costs

If you have expectations/requirements around the cost per square foot or per unit to construct this project, provide that information to the team. This is important in that it provides context to the design teams about what resources they will have at their disposal to achieve your goals. Ideally, teams will propose designs that achieve many, if not all, of the goals outlined above within the context of the proposed budget.

## APPENDIX N

### GLOSSARY

Websites listed were last accessed December 9, 2014. Please note that some of the links below may require



ORINOKA MILLS DESIGN BRIEF  
New Kensington Community Development Corporation  
2012 Enterprise Pre-Development Design Grant



## A. Organizational Background

### 1. Mission + Overview

New Kensington Community Development Corporation (NKCDC) is a nonprofit organization dedicated to revitalizing the Kensington, Fishtown, and Port Richmond neighborhoods in Philadelphia. NKCDC's mission is to strengthen the physical, social and economic fabric of the community by being a catalyst for sustainable development and community building.

In 2010, NKCDC initiated an extensive community engagement and master planning process to address vacancy and crime within a 23-acre study area in the heart of Kensington. The proposed plan envisions the creation of a vibrant neighborhood center that leverages the existing transit system, market opportunities, and proposed linear park network on the viaduct. This multi-phase neighborhood revitalization effort will first focus on one of the remaining structures that is part of the Orinoka Mills site located on the corner of Somerset and Ruth streets. This adaptive reuse and new construction project will transform the former industrial warehouse into affordable housing with much-needed commercial and community space. The future site will build off of the master plan and make tangible progress in restoring vitality and prosperity to the area.

Cutting through this neighborhood is the Lehigh Viaduct, which currently has only one active train line. The Viaduct isn't gated and attracts a large volume of drug and prostitution activity, which represents a significant challenge to development in this neighborhood. The heart of the study area, Kensington Ave. and Somerset St., was recently named the top drug corner in the city by the Philadelphia Weekly. Nevertheless, this neighborhood has several amenities. In addition to its close proximity to public transportation, there is a commercial corridor along the elevated train station. Businesses and community services in the area include a deli, a church and a bike shop. NKCDC aims to transform current liabilities into assets and restore the study area to vitality and prosperity.

### 2. Expectations

NKCDC envisions the redevelopment of the 60,000 sq. ft. Orinoka Mills structure and the 23 acres of vacant or dilapidated properties surrounding the building as an important opportunity for NKCDC to establish a presence and facilitate change in one of the most troubled spots in its service area. **This predevelopment design grant process will focus on the Orinoka Mills building and the adjacent land that extends to the viaduct (Phase I).**

Accordingly, architectural proposals for this project should focus on creating a vision for Phase I yet include a schematic strategy for the larger site, with implications for future phases and the surrounding area. The project should be mindful of the neighborhood context, but not mired in it. Proposals should be achievable, as well as visionary. The project should both stand alone and fit into the larger site and community.

## B. Project

### 1. Vision Statement

The Orinoka Mills redevelopment project will be a forward-looking and transformative force in the neighborhood while respecting the area's current and past character. The redevelopment will contribute to an array of services and an overall healthy community, preserving affordable housing and creating a more attractive neighborhood. Furthermore, the process and product will be accessible and transparent in nature, give hope to community members, and inspire other partners to further invest in local community development.



## 2. Description and Program

### Size

The project site is approximately one (1) acre. The site encompasses both the adjacent vacant lot and the Orinoka Mills structure, which totals approximately 60,000 sq. ft. including the basement level and the smaller adjacent timber building (please see the attached images).

### Population + Program

- Mixed-use: Low-to-moderate income 1-2 bedroom affordable housing on the upper four levels. Retail and office space on the two bottom levels, including partially submerged basement.
- Additional resident and tenant details are yet undecided.
- The project comprises the adaptive reuse of the mill building, with potential for a new construction addition.
- The design should include a rooftop program for the residents, as well as private access to the outdoors.
- The Phase I site should also include outdoor green space accessible to the surrounding community.
- Strive for 24-hour programming, ensuring “eyes on the street.”

## 3. Design Considerations (asterisks mark high priority areas)

### \*Site Integration + Connectivity

- Consider how the site and building relate to the surrounding neighborhood.
- The site should incorporate Transit-Oriented-Development strategies, considering the proximity of and connection to the El.
- The building should be open and accessible to the community, with a public relationship with the street.
- Strategies for Ruth Street, particularly as a less intimidating thoroughway.
- Include at least two entrances for residential and public programming.
- Include streetscape considerations along Ruth and Somerset.

### \*Safety Concerns

- Prioritize crime prevention (i.e. secure entryways) but do not propose a fortress.
- Avoid undefined common spaces and maintain defensible space (again, “eyes on the street”).
- Create an intentional environment, with well-considered streetscapes and maintained buildings that discourage illicit activity. Consider improved pavement, exterior lighting, etc. conditions to create a welcome gateway, particularly on the path to the transit hub.
- Acknowledge the area’s crime and drug issues but do not let them drive the design. What is your approach to this? Have you done any similar work in similar conditions?

### \*Sustainability + Health

- The development will strive for LEED Gold or Platinum.
- Landscaping and building design should account for stormwater management, particularly for viaduct runoff.
- Salvage as much material as possible from the existing building.
- Prioritize safe and healthy materials to maintain high indoor air quality.
- Operable windows and ceiling fans.
- Transit-oriented-development and bicycle connectivity.
- Note: There is likely necessary remediation associated for outdoor open spaces.

### Community + Open Space

- Include an outdoor green space accessible to the surrounding community.
- Consider urban agriculture and artwork on site.
- Create a balance between private and public open space, including an accessible roof that celebrates the view.
- Propose a strategy for how open space will play out on the larger site in future phases.



***Accessibility, Zoning + Maintenance***

- All spaces must be ADA accessible.
- Propose a secondary means of egress as the previous staircase was demolished.
- Maintain material durability for longer lifespan and lower costs.

***Design Identity:***

- Respect (but do not replicate) the historic character of the building and site. The community development team values the natural light and valuable historic character of the existing building.
- Reduce space dedicated to cars, minimize surface parking, and promote alternative transportation.
- The project is neither institutional looking nor fortress-like. It should be secure and deter crime.
- Include access to the outdoors and green space, either private (balcony) or communal (rooftop). Also consider green space open to the larger community.
- Develop a strategy in relation to the neighboring building, which may or may not also be renovated.



## NEW KENSINGTON'S ORINOKA MILLS: PRE-DEVELOPMENT DESIGN VISIONING ARCHITECT INVITATION

Neighborhood Context: Aerial photograph of the study site (outlined in red)



Site Detail: Aerial photograph of the Orinoka Mills site (outlined in yellow)





## APPENDIX I

# STORMWATER MANAGEMENT MILESTONE CHECKLIST FOR IEDA FUNDED PROJECTS

Recipient Name \_\_\_\_\_

IEDA Contract Number \_\_\_\_\_

Technical Advisor \_\_\_\_\_

1. Project initiation meeting held (date) \_\_\_\_\_

2. Design concept sent to technical advisor (date) \_\_\_\_\_

Design concept approved by technical advisor (date) \_\_\_\_\_

3. 30% plans and specifications sent to technical advisor (date) \_\_\_\_\_

30% plans and specifications approved by technical advisor (date) \_\_\_\_\_

4. 60% plans, specifications, and design review checklists sent to technical advisor

60% plans, specifications, and design review checklists approved by technical advisor  
(date) \_\_\_\_\_

5. 90% plans and specifications sent to technical advisor (date) \_\_\_\_\_

90% plans and specifications approved by technical advisor (date) \_\_\_\_\_

6. Maintenance plan prepared and submitted to grant applicant and technical advisor (date) \_\_\_\_\_

Maintenance plan approved by technical advisor (date) \_\_\_\_\_

Maintenance plan approved by grant applicant (date) \_\_\_\_\_

7. Final plans, design review checklists, and specifications sent to technical advisor (date) \_\_\_\_\_

Final plans, specifications, and design review checklists approved by technical advisor  
(date) \_\_\_\_\_ (signature) \_\_\_\_\_

8. Pre-construction meeting scheduled and technical advisor invited (date) \_\_\_\_\_

9. Interim inspections scheduled with the technical advisor

Stage \_\_\_\_\_ Date \_\_\_\_\_

Stage \_\_\_\_\_ Date \_\_\_\_\_

Stage \_\_\_\_\_ Date \_\_\_\_\_

Stage \_\_\_\_\_ Date \_\_\_\_\_

10. Final inspection scheduled with grant applicant, design consultant, and technical advisor.

(date) \_\_\_\_\_

11. Project Certified as Complete (date) \_\_\_\_\_ (signature) \_\_\_\_\_

12. Ensure outreach goals (if applicable) have been met from the initial application (date) \_\_\_\_\_



## APPENDIX J

# CONSTRUCTION TYPOLOGY DEFINITIONS

### SUBSTANTIAL AND MODERATE REHAB

Given that the scope of work on existing buildings can vary widely. We have defined two levels of rehabs to guide project team planning.

While Substantial and Moderate Rehabs are defined as specifically as possible below, each project will most likely have more nuance than can be captured here. Please use these definitions as the start of this guidance, strive for the most inclusive level of integrating the Criteria, and note that compliance with the energy performance requirements of Criteria 5.1a and 5.1b often is the factor that places a project in the New Construction pathway, Substantial Rehab pathway, or Moderate Rehab pathway, or precludes Certification all together.

A Substantial Rehab is defined as a project where the work area exceeds 50% of the aggregate area of the building; an International Code Council level 3 alteration scope of work, according to the most recent version of the International Existing Building Code published at the time of project plan review.

- Aggregate area of the building includes anything within the surrounding exterior walls, including covered exterior spaces, e.g., balconies that have a roof or floor above (does not include roof, outdoor space, etc.)
- Work area is defined as the area on the plans that will be considered reconfigured, addition or removal of a window or door, or reconfiguration or extension of any system, or installation of a new system.

A Moderate Rehab is defined as a project where the work area does not exceed 50% of the aggregate area of the building (the work scope is less than an ICC level 3 alteration), yet is still able to comply with the energy performance requirements of Criterion 5.1b.

### RURAL/TRIBAL/SMALL TOWN

Projects that meet one or more of the four criteria below qualify for the Rural/Tribal/Small Town pathway in the 2020 Criteria.

1. A statistical geographic entity delineated by the Census Bureau that does not meet the definition of an urbanized area contained in the Office of Management and Budget's 2010 Standards for Delineating Metropolitan and Micropolitan Statistical Areas, 75 FR 37252 (June 28, 2010). That is, a rural area is an area that is not a statistical geographic entity delineated by the Census Bureau, which would consist of densely settled census tracts and blocks and adjacent densely settled territory that together contain at least 50,000 people.
2. Projects located on Native American Reservations, Hawaiian Homesteads, and land owned by Native Alaskans.
3. Projects located in colonias communities as defined by HUD and certified by one of the four border states: Texas, New Mexico, Arizona, and California
4. Projects eligible for funding under USDA Rural Housing Services (RHS) programs



## APPENDIX K

### PROJECT PRIORITIES SURVEY

Project name: \_\_\_\_\_

Project address: \_\_\_\_\_

Complete this survey prior to beginning your integrative design process and submit with your project application to the Iowa Economic Development Authority.

Understanding the context of your project is critical to ensuring it successfully meets the needs of the building users and aligns with your intended project goals. This survey, once completed, will serve as a key component of the integrative design process during predevelopment.

#### IDENTIFY POPULATIONS SERVED (check all applicable)

Please identify the unique populations of your development below, as applicable. If your project is accommodating any eligible persons seeking housing, please select “no specific population identified.”

- |  |  |
|--|--|
| <input type="checkbox"/> Families  | <input type="checkbox"/> Supportive Housing                |
| <input type="checkbox"/> Veterans  | <input type="checkbox"/> Formerly incarcerated             |
| <input type="checkbox"/> LGBTQ   | <input type="checkbox"/> Mixed income                      |
| <input type="checkbox"/> Persons with physical or intellectual disabilities                | <input type="checkbox"/> No specific population identified |
| <input type="checkbox"/> Older Adults — Independent Living                                 | <input type="checkbox"/> Other population (describe):      |
| <input type="checkbox"/> Older Adults — Assisted Living                                    | _____  |
| <input type="checkbox"/> People experiencing homelessness or formerly homeless populations | _____  |
|  | _____  |

#### RESIDENT-EXPERT EXPERIENCE

In conversation with residents, potential residents, local stakeholders and/or other community-based groups, reply to the following questions to ensure that community members and their lived experiences are carefully considered for your project.

You must, at minimum:

- Have one conversation with one or more residents, potential residents or community members.
- Have one conversation with a current building management or resident service staff member who has regular interactions with building residents in one of your existing buildings. In new construction projects that don't have building management staff, speak with building managers or resident service staff of similar local projects.

These conversations should include the context of the project you're working on, why you want to hear their input and what you will do with it. In these conversations, we recommend seeking to understand more about the place and community context — what community members value most, their concerns, what works and what doesn't work in their current residences.



---

## APPENDIX K: PROJECT PRIORITIES SURVEY (CONTINUED)

### *I. Community Reflection and Understanding*

Your answers in this section should be informed by: individual vulnerability factors (as applicable), like age, health, physical ability, language, geographic isolation, and employment, as well as sources of stress such as extreme weather, poor physical infrastructure, and limited proximity to jobs, services, or transit.

1. Who does this development serve? Who does it not serve? Among those populations it is intended to serve, who is most vulnerable?

2. Identify some challenges and opportunities people you serve (particularly the most vulnerable) are facing. What are the root causes of those challenges?

3. What are the assets, cultural norms or community resources this community uses use to overcome challenges?

4. What are the opportunities for ongoing resident leadership in the design and development of this project?



## II. Ground Truth

What forms of feedback have you used or will you use for input from residents or target users to inform your priorities for this project? Please check all that apply.

We recommend talking to target groups about how they feel comfortable giving feedback to ensure methods are appropriate to the people you want to hear from. Select a combination of methods that complement each other and align with preferred ways to provide feedback. This is easiest when integrated in project and staff expectations from the outset.

- Surveys Interviews Focus groups
- Suggestion box/“Dropbox” for confidential feedback
- Community designed feedback systems; communities decide what and how they would like to provide feedback (*please specify*):

- Other (*describe*):

### COMPREHENSIVE COMMUNITY DESIGN

How does your approach to and results from Community Reflection and Ground Truth (Sections I and II, above) inform the design process and design features of your development?



---

## IDENTIFY RESIDENT OPPORTUNITY FACTORS

Housing is a foundation for health and quality of life. Project design, development, operations, and management, as well as programs, play a significant role in influencing the health and cultural resilience outcomes for residents.

1. Go to [www.enterprisecommunity.org/opportunity360](http://www.enterprisecommunity.org/opportunity360).
2. Review the Opportunity360 webpage, then scroll down and select “Measure” under the Toolkit.
3. Review the Measure page and then scroll down and click on the map.
4. You will be asked to input your contact information in a pop-up window; input your name, email, and the zip code of your project. Click “Submit.”
5. When the text bubble appears, select “Get Enterprise Opportunity Report.” Download and review your customized PDF Report. Note: Save the PDF of the report, once downloaded, for future reference.

Review the five opportunity outcomes in the customized Enterprise Opportunity Report that has been generated for your address, then answer the following questions:

1. What did you learn about your community that you did not know prior to the Opportunity Report?

2. How will this new information impact your project?

3. How do you plan to leverage the community assets identified through the Opportunity Report with your project?





4. What did you learn about the health of residents in your community that you should consider when designing and developing this project?

Note: To earn Enterprise Green Communities Certification to the 2020 Criteria, each project must achieve at least one of the three Promoting Health Through Design criteria listed in Category 7: Healthy Living Environment. Those criteria are:

- 7.11 Active Design: Promoting Physical Activity
- 7.12 Beyond ADA: Universal Design
- 7.13 Healing-Centered Design

Be sure to reference the community health information you've learned throughout completing this Project Priorities Survey when you elect which of these criteria you will pursue.

### UNDERSTANDING BUILDING EMISSIONS

Central to the 2020 Enterprise Green Communities Criteria is recognizing the role buildings play in impacting our climate. The overall climate impact of a property will be determined by the sum of the building's embodied emissions (associated with building material choices) and operating emissions (associated with how much energy the property uses and the emissions profile of the source of the energy). Reducing emissions is important to consider for affordable housing development because the acute impacts of climate change will be borne disproportionately by people with limited economic needs.

If reducing emissions associated with your development were your top priority, consider the following guidelines:

1. Reduce the amount of energy your property requires and utilize a low-emissions energy source when possible.
  - Review Category 5 and consider the greatest level of building performance that your project can meet cost-effectively.
  - Indicate Category 5 criteria that promote energy efficiency that your team might consider, beyond what is required in Criterion 5.1. See if there are requirements or financial incentives for these levels of building performance in your jurisdiction. Is your project able to move toward Zero Energy?

If so, check the applicable box:

5.2a Moving to Zero Energy: Additional Reductions in Energy Use

5.2b Moving to Zero Energy: Near Zero Certification (ZERH, PHI, and PHIUS)



- These Category 5 criteria have the potential to reduce emissions associated with the source of energy in your property. Indicate which of these your team may consider:
  - 5.3a: Moving to Zero Energy: Photovoltaic/Solar Hot Water Ready
  - 5.3b: Moving to Zero Energy: Renewable Energy
  - 5.4: Achieving Zero Energy (this also includes aggressive energy efficiency)
  - 5.5a: Moving to Zero Carbon: All-Electric Ready
  - 5.5b: Moving to Zero Carbon: All Electric
- 2. Review Criterion 6.5 to consider how to minimize your project’s embodied emissions, given different design schemes and material selections in your project. The decisions you make in specifying materials used in your building may have a larger impact on emissions than reducing your project’s operating emissions.
- 3. Understand, at a regional scale, how much carbon dioxide (CO<sub>2</sub>) is associated with supplying energy to your building.
  - Visit [www.epa.gov/energy/power-profiler/#/](http://www.epa.gov/energy/power-profiler/#/) to understand the emissions associated with electricity in your area. Enter the 5-digit zip code of your project, and press “Go.” The website will then display emissions rates for your region, and compares those rates to the national average. Write the emissions rate for carbon dioxide (CO<sub>2</sub>), based on your region: \_\_\_\_\_



Projects served by electric grids with lower CO<sub>2</sub> emissions may have a greater impact at reducing their overall building emissions by focusing on reducing embodied emissions associated with building materials.

Projects served by electric grids with greater CO<sub>2</sub> emissions should also reduce embodied emissions associated with building materials. Also, consider non-grid power sources with low emissions rates, like installing on-site renewables or procuring community solar or verified renewable energy certificates (RECs).

## CLIMATE AND ENVIRONMENTAL RESILIENCE

Resilient design is the intentional design of buildings, landscapes, communities and regions in response to vulnerabilities to minimize the impact on residents and local community members. The best way to maintain or regain functionality when there is a stress or disturbance, such as a disaster or significant weather event, is to plan for it.

- A. On Table 1 on the following page, identify the direct hazards that may impact your proposed project. Mark hazards that are relevant, or may be relevant to your project, with an X (Column 2). To do this, review your local (city, county, state) hazard mitigation plan(s), which are typically readily available online. If they are not available, you can use one of the following resources:
- Federal Alliance for Safe Homes (FLASH) — Top Perils in Your Area: [www.flash.org/perils.php](http://www.flash.org/perils.php)
  - Climate Central — Top Climate Hazards in 2050: [www.climatecentral.org/gallery/maps/top-climate-hazards-in-2050](http://www.climatecentral.org/gallery/maps/top-climate-hazards-in-2050) (Note: Scroll down the page to find a menu of 244 U.S. cities, which are listed by state, then city.)

If you have a professional who is able to help you determine the appropriate and relevant hazards (e.g., civil engineer, environmental engineer, structural engineer), you should consult them.

For rehabilitation projects, consider not only future conditions at the site, but confirm with the operations team at the building which hazards have been an issue at the site to date.



- B. Provide the source that helped your project team identify the applicable hazard. List the hazard mitigation plan, website, professionals, or other resources that helped you identify relevant hazards (Column 3).
- C. Next, identify potential risks of all potential hazards. Risks should be considered for residents, for the building itself, for business continuity, and for the community at-large (Column 4).
- D. Work with your entire development team, contractor, and consultants, to identify the priority for building mitigation for all applicable hazards (Column 5).

**TABLE 1: CLIMATE AND ENVIRONMENTAL RESILIENCE: HAZARDS AND MITIGATIONS**

COLUMN 1	COLUMN 2	COLUMN 3	COLUMN 4	COLUMN 5
<b>Hazards</b>	<b>Is the hazard applicable?</b>	<b>Sources of information? (Where/ how did you find this information?)</b>	<b>Risk/s to residents, buildings, community, businesses (Consider vulnerable populations identified earlier)</b>	<b>Priority for building (low, medium, high)</b>
Flooding (river or coastal)				
Extreme temperatures: heat				
Extreme temperatures: cold (i.e., winter storms, hail, blizzards)				
Severe high winds				
Fire				
Explosion				
Earthquake				
Hurricane				
Tornado				
Rain event				
Tsunami				
Wildfire				
Unstable soils, land cover change				



## WRITE YOUR PROJECT MISSION

Your project mission should be a high-level statement of what the project will achieve for the community when the building is placed in service. Your project mission should be short (no more than two sentences) and direct, using clear language free of industry jargon.

It is important that all project team members have a clear and common understanding of what the goals of the proposed development are.

Your project mission should be different and distinct from your organizational mission but should reflect the values of your organization.

Review the Project Mission Writer tool found on the Enterprise Community Partners Design Matters website.

1. Enterprise Community Partners, Design Matters.  
[www.enterprisecommunity.org/solutions-and-innovation/design-leadership/designmatters](http://www.enterprisecommunity.org/solutions-and-innovation/design-leadership/designmatters)
2. Enterprise Community Partners, Design Matters: Project Mission Writer Tool.  
[www.enterprisecommunity.org/sites/default/files/media-library/solutions-and-innovation/design/DesignMatters/Design-Matters\\_Project-Mission-Writer.pdf](http://www.enterprisecommunity.org/sites/default/files/media-library/solutions-and-innovation/design/DesignMatters/Design-Matters_Project-Mission-Writer.pdf)

## EXAMPLE PROJECT MISSIONS

1. Prioritize a healthy and connected resident experience through healing centered design that includes warm amenity and transition spaces with opportunities for resident self-expression, moments of connection, accessible first floor community spaces and access to nature. Connect to the surrounding neighborhood by prioritizing early community engagement and providing public green spaces designed to meet resident and community needs.
2. Develop comfortable spaces that meet the unique needs of veterans, and offer access to centralized physical, social, and mental health services that allow residents to heal and thrive.

The design will foster connection among residents by creating spaces with a gradient of privacy and with the broader community through an inviting campus.

3. Create farmworker housing that enhances farmworkers' financial well-being and quality of life, by limiting utility costs through energy efficient building placement and features, tailoring building designs to the farmworker lifestyle (such as providing adequate outdoor farm gear storage) and reflecting local cultural practices throughout the design.

## PROJECT MISSION

---

SIGNATURE

---

DATE

Submit your completed Project Priorities Survey with your Prebuild application in the Green Communities online portal.



## APPENDIX L

### SCAQMD TABLES FOR USE WITH CRITERION 6.4

Projects must not exceed the VOC limits from the most recent version of these rules available at time of product specification.

For the latest rules, see [www.aqmd.gov/home/rules-compliance/rules/scaqmd-rule-book/regulation-xi](http://www.aqmd.gov/home/rules-compliance/rules/scaqmd-rule-book/regulation-xi)

As of September 25, 2019, a selection of the published thresholds are as follows:

#### ALL INTERIOR PAINTS, COATINGS, PRIMERS: SCAQMD 1113

PRODUCT TYPE	MAXIMUM VOC LIMIT (G/L)
Primers, sealers, and undercoatings	100
Coatings, flats and non-flats, and floor	50
Rust-preventive coatings	100
Wood coatings	275
Stains, interior	250
Tub and tile refinishing coatings	420

#### ALL INTERIOR ADHESIVES AND SEALANTS: SCAQMD 1168

PRODUCT TYPE	MAXIMUM VOC LIMIT (G/L)
Indoor floor covering adhesives	50
Carpet pad adhesives	50
Outdoor floor covering adhesives	150
Wood flooring adhesives	100
Rubber floor adhesives	60
Subfloor adhesives	50
Vinyl composition tile and asphalt tile adhesives	50
Drywall and panel adhesives	50
Cove base adhesives	50
Multipurpose construction adhesives	70
Structural glazing adhesives	100
Structural wood member adhesive	140
Architectural sealants: clear, paintable, and immediately water-resistant	250
Architectural sealant primers: nonporous	250
Architectural sealant primers: porous	775



---

## APPENDIX M

# UNIVERSAL DESIGN CHECKLIST REQUIRED AND BONUS BEST PRACTICES

Universal design concepts target all people of all ages, sizes, and abilities and is applied to all buildings. The Center for Universal Design at North Carolina State University defined universal design as, “design of products and environments to be usable by all people, to the greatest extent possible, without the need for adaptation or specialized design.” Or as Steve Hoffacker, Certified Aging in Place Specialist – Master Instructor, puts it, “Universal design is providing all functional and operational aspects of a home (controls, doorways, passageways, appliances, fixtures, closets, cabinets, windows, door and cabinet hardware, and more) where they can be used by essentially anyone in the home, whether they live there full-time or are just visiting.”

Comprehensive integration of universal design best practices can make homes safe and accessible for everyone, regardless of age, physical ability, or stature. This checklist of universal design best practices was adapted from The Center for Universal Design at North Carolina State University publication “Gold, Silver and Bronze Universal Design Features in Houses.”

This checklist is divided into three divisions.

- Division 1 Required Best Practices
- Division 2 Bonus Best Practices.
- Division 3 Universal Design Resources

### **Division 1: Required Best Practices (Fulfills Green Streets Criteria Baseline Criterion 7.12)**

The Universal Design practices covered in this section are deemed to be construction best practices and of no or low additional cost.

### **Division 2: Bonus Best Practices**

The Universal Design practices covered in this section, while still considered best practices, may be of moderate additional cost or unique to each home’s construction. Community Development Block Grant Disaster Recovery (CDBG-DR) Housing projects with an interest in pursuing the complete installation of these bonus best practices are eligible to apply for additional funding.



## DIVISION 1: REQUIRED BEST PRACTICES

### SECTION 1. ENTRANCE

#### □ 1.1 Stepless Entrances

Install at least one stepless entrance. If only one, not through a garage or from a patio or raised deck.

- Level bridges to uphill point.
- Drive and garage elevated to floor level, so vehicles do the climbing.
- Earth berm and bridge and sloping walk details.
- Site grading and earth work (with foundation waterproofing) and sloping walks at 1 in 20 maximum slope.
- Avoid ramps. If ramps are used, integrate into the design.

#### □ 1.2 Other Entrances

- One-half inch maximum rise at entrance thresholds.
- Provide clearance/maneuvering space at doors to comply with ANSI A117.1.
- Space at entry doors should be a minimum 5' x 5' level clear space inside and outside of entry door for maneuvering while opening or closing door.
- Clear door opening width (34" minimum = 36" wide doors), for all entrance doorways.

#### □ 1.3 Other Entrance Features

- Light for operating at entry doors: focused light on lockset, general illumination for seeing visitors at night, and/or motion detector controls that turn on lights when someone approaches the door to eliminate the problem of dark approaches to home and adds a sense of security.
- View of visitors for all people, including children and seated users through sidelights, wide angle viewers, TV monitors, windows in doors, and/or windows nearby.
- A place to put packages while opening doors: built-in shelf, bench or table with knee space below located on the outside next to the door.
- A way for visitors to communicate with residents, such as lighted doorbell at a reachable height, intercom with portable telephone link, and/or hardwired intercom.
- Address/house number should be large, high contrast, located in a prominent place, easy for friends and emergency personnel to locate.

### SECTION 2. CIRCULATION

#### □ 2.1 Interior Circulation

- At least one bedroom and accessible bathroom should be located on an accessible ground floor entry level (same level as kitchen, living room, etc.).
- Clear door opening width (32" minimum, 34" - 36" wide doors), for all doorways. Consider Interior pocket doors and when fully open door should extend 2" minimum outside door jamb and be equipped with open-loop handles for easy gripping.
- Clear floor space (18" minimum) beside door on pull side at latch jamb provides space to move out of the way of the door swing when pulling it open.
- Circulation route (42" minimum width) to provide maneuvering room in hallways/archways.
- Turning space in all rooms (60" diameter required, 66" diameter preferred).
- An open plan design, minimizing hallways and doorways and maximizing sight lines.
- Floor finishes that minimize glare, are slip resistant, & low resistance to walking or rolling.



2.2 Vertical Circulation

- Stair handrails placed on both sides of stairs.

### **SECTION 3. BATHROOMS**

3.1 Adequate Maneuvering Space

- Adequate maneuvering space: 60" (66" preferred) turning space in the room and 30" x 48" clear floor spaces at each fixture. Spaces may overlap.
- Provide clear space per ANSI 117.1 in front and to one side of toilet to allow for easy maneuvering to and around toilet.
- Toilet centered 18" from any side wall, cabinet or tub.

3.2 Toilet

- Install all comfort height toilets at height of 17 to 19 inches from the floor to the seat top.

3.4 Extra Blocking / Grab Bars

- Extra blocking in walls around toilet, tub, and shower allows for future placement and relocation of grab bars while assuring adequate load bearing.

3.5 Fixture Controls - Bathroom

- Single-lever water controls at all plumbing fixtures and faucets.
- Mix valve with pressure balancing and hot water limiter prevents scalding people.
- Adjustable height, movable hand-held shower heads in all tubs and showers, in addition to fixed heads, if provided. Single lever diverter valves if needed.
- Offset controls in tub/shower with adjacent clear floor space allows for easy access from outside the tub with no inconvenience when inside.

3.6 Mirrors

- Long mirrors should be placed with bottom no more than 36" above finished floor and top at least 72" high. Full-length mirrors are good choices.

### **SECTION 4. KITCHENS**

4.1 Cabinets / Storage

- Space between face of cabinets and cabinets and walls should be 48" minimum.
- Full-extension, pull-out drawers, shelves and racks in base cabinets for easy reach to all storage (NOT REQUIRED, BUT RECOMMENDED AND PREFERRED).
- Adjustable height shelves in wall cabinets.
- Pantry storage with easy access pull-out and/or adjustable height shelves for easy reaching of otherwise hard-to-get items.

4.2 Fixture Controls - Kitchen

- Single-lever water controls at all plumbing fixtures and faucets.

4.3. Appliances (if provided)

- Front mounted controls on appliances to facilitate easy reach.
- Side-by-side refrigerator allows easy reach of otherwise hard-to-get items, particularly if pull-out shelving is provided.





## **SECTION 5. SWITCHES AND CONTROLS**

### 5.1 Light Switches

- Locate light switches above floor, 36" - 44" maximum.
- Easy-touch rocker or hands-free switches.

### 5.2 Electrical Outlets

- Install electrical outlets, at least 20" minimum height from the floor.
- Place additional electrical outlets at bed locations and desk for equipment, four-plex boxes each side for computer and electronic equipment as well as personal use equipment.

### 5.3 Electrical Panels

- Locate electrical panel with top no more than 54" above floor located with a minimum 30" x 48" clear floor space in front.

### 5.4 Thermostats

- Place thermostats at 48" maximum height.

## **SECTION 6. GARAGES / CARPORTS**

### 6.1 Garage Doors

- Install power operated overhead doors.

## **SECTION 7. HOME AUTOMATION**

### 7.1 Lights

- Motion detector light switches in garages, utility spaces, entrances, and basements.
- Remote controls for selected lights.

### 7.2 Heating and Cooling System

- Remote controls for heating and cooling. (May connect to Green Streets required smart thermostat.)

### 7.3 Safety Features

- Audible and visual indicators for doorbell.
- Audible and visual indicators for smoke detectors.

## **SECTION 8. STORAGE**

### 8.1 Storage and Closets

- 50% of storage to be no more than 54" high.
- Adjustable height closet rods and shelves allow for flexibility of storage options.

## **SECTION 9. HARDWARE**

### 9.1 Knobs, Handles and Pulls

Install easy to use hardware, requiring little or no strength or flexibility.

- Use lever door handles and / or push plates.
- Install loop handle pulls on drawers and cabinets or use touch latches or mechanical latches (NOT REQUIRED, BUT RECOMMENDED AND PREFERRED).
- Provide keyless locks.

## **SECTION 10. WINDOWS**

### 10.2 Window Height

- Install windows for viewing with a 36" maximum sill height.



## DIVISION 2: BONUS BEST PRACTICES

### SECTION 1. ENTRANCE - BONUS

#### □ 1.2 Other Entrance Features

- Weather protection shelter while unlocking and opening doors, such as porches, stoop with roof, awnings, long roof overhangs, and/or carport.

### SECTION 3. BATHROOMS - BONUS

#### □ 3.3 Sink

- Countertop lavatories preferred with bowl mounted as close to front edge as possible.
- Wall hung lavatories acceptable with appropriate pipe protection.
- Knee space under lavatory (29" high) allows someone to use lavatory from a seated position. May be open knee space or achieved by removable vanity or fold-back or self-storing doors.
- Pipe protection panels must be provided to prevent contact with hot or sharp surfaces.
- Pedestal lavatories are not acceptable

#### □ 3.6 Shower / Tub

- Minimum 5' x 3' (4' preferred), deep curbless shower. OR
- Tub with integral seat, waterproof floor, and a floor drain. OR
- Other bathrooms in the same house may have a tub with an integral seat or a 3' x 3' transfer shower with "L" shaped folding seat and 1/2" maximum lip (curb) in lieu of fixtures described above. When more than one bathroom has the same type of bathing fixture (a tub, shower, wet area shower), at least one shower should be arranged for left-hand use and one for right.

### SECTION 4. KITCHENS - BONUS

#### □ 4.3. Appliances

- Cook top or range with staggered burners and front or side mounted controls to eliminate dangerous reaching over hot burners
- Cook top with knee space below allows someone to use the appliance from a seated position. May be open knee space or achieved by means of removable base cabinets or fold-back or self-storing doors. Pipe protection panels must be provided to prevent contact with hot or abrasive surfaces.
- Built-in oven with knee space beside, set for one pull-out oven rack at the same height as adjacent counter top OR drop-in range with knee space beside, top set at 34" above finished floor.
- Dishwasher raised on a platform or drawer unit, so top rack is level with adjacent countertop, puts bottom racks within easy reach requiring less bending.

#### □ 4.4 Counters

- Contrasting color border treatment on countertops. Color or contrast difference allows easy recognition of the edges of counters and the different heights to prevent accidental spills.
- Stretches of continuous counter tops for easy sliding of heavy items.



## **SECTION 6. GARAGES / CARPORTS - BONUS**

### □ 6.2 Garage Entrance

- Provide extra length and width inside for circulation around parked cars.
- Door height and headroom clearances (8' minimum) for tall vehicles or provide alternative on-site outdoor parking space.
- Do not install entrance ramps in garages.
- If necessary, to provide step-free entrance, use a sloping garage floor (with through-the-wall vents at bottom of slope to release fumes) in lieu of stepped entrance with ramp from garage to house.

## **SECTION 10. WINDOWS - BONUS**

### □ 10.1 Window Types

- Install casement and crank operated windows.

## **DIVISION 3: UNIVERSAL DESIGN RESOURCES**

Building Zero-Step Entries

[www.jlconline.com/projects/building-zero-step-entries\\_o](http://www.jlconline.com/projects/building-zero-step-entries_o)

Enterprise Green Communities Universal Design Specifications (Note: Time saving specifications.)

[www.enterprisecommunity.org/download?fid=4713&nid=3575](http://www.enterprisecommunity.org/download?fid=4713&nid=3575)

Gold, Silver and Bronze Universal Design Features in Houses

[projects.ncsu.edu/www/ncsu/design/sod5/cud/pubs\\_p/docs/GBS.pdf](http://projects.ncsu.edu/www/ncsu/design/sod5/cud/pubs_p/docs/GBS.pdf)

Practical Guide to Universal Home Design: Convenience, Ease and Livability

[www.environmentsforall.org/files/2015/10/practicalguide.pdf](http://www.environmentsforall.org/files/2015/10/practicalguide.pdf)

Residential Remodeling and Universal Design (Note: Helpful images of best practices.)

[www.huduser.gov/publications/pdf/remodel.pdf](http://www.huduser.gov/publications/pdf/remodel.pdf)

Should it Cost More to Build or Renovate With Universal Design?

[www.stevhoffacker.com/2018/11/10/should-it-cost-more-to-build-or-renovate-with-universal-design/](http://www.stevhoffacker.com/2018/11/10/should-it-cost-more-to-build-or-renovate-with-universal-design/)

Universal Design Strategies

[www.stevhoffacker.com/universal-design-strategies/](http://www.stevhoffacker.com/universal-design-strategies/)

What is Design for Independent Living?

[www.nahb.org/Education-and-Events/Education/Designations/Certified-Aging-in-Place-Specialist-CAPS/Additional-Resources/What-is-Design-for-Independent-Living](http://www.nahb.org/Education-and-Events/Education/Designations/Certified-Aging-in-Place-Specialist-CAPS/Additional-Resources/What-is-Design-for-Independent-Living)



subscriptions to access content.

**Active Design:** An approach to the development of buildings, streets and neighborhoods that uses architecture and urban planning to make daily physical activity and healthy foods more accessible and inviting.

**Adaptive plant species:** A non-native plant species that performs similarly to a native species in a particular region, state, ecosystem and habitat, and that 1) can survive temperature / weather extremes in the microclimate; 2) requires little irrigation or fertilization, once established; 3) is resistant to local pests and diseases; and 4) does not displace other plants, as invasives do.

**Adaptive reuse building:** An existing building that is being renovated to accommodate a new use, e.g., rehabilitating an old school for use as housing.

**Air barrier:** Air barriers are systems of materials designed and constructed to control airflow between a conditioned space and an unconditioned space. The air barrier system is the primary air enclosure boundary that separates indoor (conditioned) air and outdoor (unconditioned) air. In multi-unit /townhouse / apartment construction, the air barrier system also separates the conditioned air from any given unit and adjacent units. [www.buildingscience.com/documents/digests/bsd-104-understanding-air-barriers](http://www.buildingscience.com/documents/digests/bsd-104-understanding-air-barriers)

**ASHRAE (American Society of Heating, Refrigerating and Air-Conditioning Engineers) Standard 62.1 and 62.2-2016:** ANSI/ASHRAE Standards 62.1 and 62.2 are the recognized standards for ventilation system design and acceptable IAQ. [www.ashrae.org/standards-research--technology](http://www.ashrae.org/standards-research--technology)

**ASHRAE Standard 90.1:** Provides the minimum requirements for energy-efficient design of most buildings, except low-rise residential buildings. It offers, in detail, the minimum energy-efficient requirements for design and construction of new buildings and their systems, new portions of buildings and their systems, and new systems and equipment in existing buildings, as well as criteria for determining compliance with these requirements.

**Berm:** A sloped wall or embankment, typically constructed of earth, hay bales or timber framing, used to prevent inflow or outflow of material into or out of an area. [www.epa.gov/OUST/pubs/tum\\_appx.pdf](http://www.epa.gov/OUST/pubs/tum_appx.pdf)

**Building Performance Institute (BPI):** A national standards development and credentialing organization for residential energy-efficiency retrofit work that provides training through a network of affiliate organizations, individual certifications, company accreditations and quality assurance programs.

**California 01350:** A Special Environmental Requirements standard specification developed by the state of California to cover key environmental performance and public health considerations for building projects. Contains guidelines for energy, materials, water efficiency, indoor air quality (IAQ), nontoxic performance standards for cleaning and maintenance products, and sustainable site planning and landscaping considerations, among other measures. [www.calrecycle.ca.gov/greenbuilding/specs/section01350](http://www.calrecycle.ca.gov/greenbuilding/specs/section01350)

**CFM (cubic feet per minute):** A standard unit of measurement for airflow that indicates how many cubic feet of air are passing through a fixed point per minute.



**Charrette:** An intense work session that brings together a diverse group of housing professionals as well as funders, policymakers, health practitioners and community stakeholders to integrate sustainable green design principles into affordable housing developments before schematic designs are complete. A charrette sets the stage for a clear vision of project goals and individual responsibilities, but not necessarily final design decisions. [www.enterprisecommunity.org/solutions-and-innovation/green-communities/tools-and-services/charrette-toolkit](http://www.enterprisecommunity.org/solutions-and-innovation/green-communities/tools-and-services/charrette-toolkit)

**Common area:** An area available for use by more than one person, including rental or sales offices, entrances, hallways, shared activity or leisure rooms, resident services areas, and laundry rooms.

**CSA (Community-Supported Agriculture):** A community of individuals who pledge support to a farm operation so that the farmland becomes the community's farm, with the growers and consumers providing mutual support and sharing the risks and benefits of food production. Typically, members of the farm

or garden pledge in advance to cover the anticipated costs of the farm operation and the farmer's salary. In return, they receive shares in the farm's bounty throughout the growing season. Members also share in the risks of farming, including poor harvests due to unfavorable weather or pests.

[www.nal.usda.gov/afsic/pubs/csa/csadef.shtml](http://www.nal.usda.gov/afsic/pubs/csa/csadef.shtml)

**Compost blanket:** A layer of loosely applied compost or composted material that is placed on the soil in disturbed areas to control erosion and retain sediment resulting from sheet-flow runoff.

[www.epa.gov/large-scale-residential-demolition/managing-stormwater-and-dust-demolition-sites](http://www.epa.gov/large-scale-residential-demolition/managing-stormwater-and-dust-demolition-sites)

**CO (carbon monoxide):** A colorless, odorless and tasteless gas that greatly affects indoor air quality. Because it is impossible to see, taste or smell the toxic fumes, CO can kill you before you are aware that it is in your home. At lower levels of exposure, CO causes mild effects that are often mistaken for the flu. These symptoms include headaches, dizziness, disorientation, nausea and fatigue.

[www.epa.gov/indoor-air-quality-iaq/carbon-monoxides-impact-indoor-air-quality](http://www.epa.gov/indoor-air-quality-iaq/carbon-monoxides-impact-indoor-air-quality)

**Dial-a-ride program:** A privately or publicly operated program that provides an on-demand ride service, requiring passengers to call ahead to reserve a ride. These programs usually provide connections between different transportation systems and/or employment centers.

**Distribution uniformity:** A measure of the evenness of irrigation water coverage over a defined area.

[www.epa.gov/sites/production/files/2017-01/documents/ws-homes-irr-audit-guidelines.pdf](http://www.epa.gov/sites/production/files/2017-01/documents/ws-homes-irr-audit-guidelines.pdf)

**Dwelling unit:** A single unit providing the complete independent living facilities for one or more people, including permanent provisions for living, sleeping, eating, cooking and sanitation. From Addendum J to ASHRAE 62.2-2010, found online at:

[www.ashrae.org/standards-research--technology/standards-addenda](http://www.ashrae.org/standards-research--technology/standards-addenda)

**ECM (electronically commutated motor):** Also known as brushless DC motors, ECMs are synchronous motors that are powered by a DC electric source via an integrated inverter/switching power supply that produces an AC electric signal. Used, for example, in HVAC equipment that uses electricity efficiently, particularly at lower speeds.

**Emissivity:** A unitless measure describing the relative ability of a surface to emit radiation energy ranging from 0.00 (minimum radiation of heat) to 1.00 (maximum radiation of heat). More reflective materials have a lower emissivity.



**Employer vanpool:** A program in which 5 to 15 people (over the age of 16) ride together to and from work. The vanpool may be public or private, but must carry all passengers more than half the distance to work to qualify. Vanpools may be employer-operated, sponsored by transit agencies, or administered by third-party operators.

**ENERGY STAR:** A voluntary labeling program designed to identify and promote energy-efficient products to reduce greenhouse gas emissions. Introduced by the EPA in 1992, ENERGY STAR also offers an accepted national standard for certifying new residential construction projects. [www.energystar.gov](http://www.energystar.gov)

**Engineered wood products:** Wood building materials manufactured by gluing particles, fibers or veneers to increase strength. For the purposes of Criterion 6.5 Certified, Salvaged and Engineered Wood Products, Green Communities considers prefabricated and precut wood products as “engineered wood products.” [www.astm.org/SNEWS/JUNE\\_2003/yeh\\_jun03.html](http://www.astm.org/SNEWS/JUNE_2003/yeh_jun03.html)

**Entryway:** Threshold separating the indoor space from the outdoor space.

**Environmental site assessment:** An investigation of the site’s conditions often performed before acquisition of a property to satisfy the due-diligence requirements of a property transaction.

**Erosion blankets or geotextile mats:** Porous fabrics used for a variety of purposes, including separators, reinforcement, filtration and drainage, and erosion control. [www.epa.gov/large-scale-residential-demolition/managing-stormwater-and-dust-demolition-sites](http://www.epa.gov/large-scale-residential-demolition/managing-stormwater-and-dust-demolition-sites)

**Filter sock:** A mesh tube filled with composted material that is placed perpendicular to sheet-flow runoff to control erosion and retain sediment in disturbed areas. [www.epa.gov/large-scale-residential-demolition/managing-stormwater-and-dust-demolition-sites](http://www.epa.gov/large-scale-residential-demolition/managing-stormwater-and-dust-demolition-sites)

**Formaldehyde:** A chemical used widely by industry to manufacture building materials and numerous household products. Formaldehyde is also a byproduct of combustion and certain other natural processes, and thus may be present in substantial concentrations both indoors and outdoors. Health effects include eye, nose and throat irritation; wheezing and coughing; fatigue; skin rash; and severe allergic reactions. High levels of exposure may cause some types of cancer. [www.epa.gov/iaq/formaldehyde.html](http://www.epa.gov/iaq/formaldehyde.html)

**Slab:** One type of foundation, with many variations (monolithic slabs, floating slabs, rat slabs, in conjunction with a basement, etc.), that may be above, at or below grade. Wood frame crawl foundations are an alternative to slabs.

**Greenfield:** A previously undeveloped parcel of land.

**Green roof:** A planted roof that reduces stormwater runoff. [www.epa.gov/soakuptherain/soak-rain-green-roofs](http://www.epa.gov/soakuptherain/soak-rain-green-roofs)

**Greywater:** Wastewater produced from baths and showers, clothes washers and lavatories. Greywater gets its name from its cloudy appearance and from its status as being neither fresh (as in potable water) nor heavily contaminated (as in blackwater from toilet waste). [greywateraction.org/greywater-reuse](http://greywateraction.org/greywater-reuse)

**HERS Index (Home Energy Rating System Index):** A scoring system established by the Residential Energy Services Network (RESNET) in which a home built to the specifications of the HERS Reference Home (based on the 2006 International Energy Conservation Code) achieves a HERS Index score of 100, while a net zero energy home achieves a HERS Index score of 0. The lower a home’s HERS Index score, the more energy-efficient it is in comparison to the HERS Reference Home. Each 1-point decrease in the HERS Index score corresponds to a 1% reduction in energy consumption compared to the HERS Reference Home; thus, a home with a HERS Index score of 85 is 15% more energy-efficient than the HERS Reference Home, and a home with a HERS Index score of 80 is 20% more energy-efficient.



**Health Impact Assessment (HIA):** A systematic process that uses an array of data sources and analytic methods and considers input from stakeholders to determine the potential effects of a proposed policy, plan, program or project on the health of a population and the distribution of those effects within the population. An HIA provides recommendations on monitoring and managing those effects.

[www.pewtrusts.org/en/projects/health-impact-project/health-impact-assessment](http://www.pewtrusts.org/en/projects/health-impact-project/health-impact-assessment)

**Home Energy Rating:** An analysis of a home's construction through plans and on-site inspections. Based on the home's plans, the Home Energy Rater uses an energy-efficiency software package to perform an energy analysis of the home's design. This analysis yields a projected, pre-construction HERS Index.

Upon completion of the plan review, the rater will work with the builder to identify the energy-efficiency improvements needed to ensure that the house will meet ENERGY STAR performance guidelines. The rater then conducts on-site inspections, typically including a blower door test (to test the tightness of the dwelling unit envelope) and a duct leakage test (to test the tightness of the ducts). Results of these tests, along with inputs derived from the plan review, are used to generate the HERS Index score for the home.

**IECC (International Energy Conservation Code):** A model building energy code created by the International Code Council to set a minimum standard for energy efficiency; updated on a three-year schedule.

[www.iccsafe.org](http://www.iccsafe.org)

**Infill site:** A site with 75% of its perimeter bordering existing development or roads and with access to existing infrastructure.

**Integrative design:** A design approach that brings together at an early stage in project planning all the members of the building stakeholder community, and the technical planning, design and construction team (including green building consultants such as the green rater, mechanical engineer /energy expert and others) to look at the project objectives, building materials, systems and assemblies from many different perspectives. This approach is a deviation from the typical planning and design process of relying on the expertise of specialists who work in their respective specialties somewhat isolated from each other.

[www.enterprisecommunity.org/solutions-and-innovation/green-communities/tools-and-services/charrette-toolkit](http://www.enterprisecommunity.org/solutions-and-innovation/green-communities/tools-and-services/charrette-toolkit)

**Intermittent rate:** Ventilation that stops and starts at regular intervals (i.e., the opposite of continuous ventilation).

**LED (light-emitting diode):** Energy-efficient light technologies that produce less initial heat per lumen, consume less energy, and last longer than conventional incandescent and fluorescent lights.

**Low-impact development:** A strategy of site design where the goal is to restore the natural, pre-developed ability of an urban site to absorb stormwater. [www.epa.gov/nps/urban-runoff-low-impact-development](http://www.epa.gov/nps/urban-runoff-low-impact-development)

**Maintained solar reflectance:** A measure of a material's ability to maintain its initially rated solar reflectance. Products are tested over a period of three years.

**Manual D:** Manual prepared by the Air Conditioning Contractors of America (ACCA) on designing residential duct systems. [www.acca.org/technical-manual/manual-d](http://www.acca.org/technical-manual/manual-d)

**Manual J:** Manual prepared by ACCA on determining heating and cooling loads of residential structures. [www.acca.org/technical-manual/manual-j](http://www.acca.org/technical-manual/manual-j)

**Manual S:** Manual prepared by ACCA on selecting residential heating and cooling equipment to match the heating and cooling loads of residential structures. [www.acca.org/technical-manual/manual-s](http://www.acca.org/technical-manual/manual-s)



**Moderate rehabilitation:** A project that does not fully expose the structure and envelope of the building and/or does not include replacement or improvement of two or more major systems of the building, yet is still able to comply with the energy performance requirements of at least one iteration of Criterion 5.1.

**Native plant species:** A plant species that occurs naturally in a particular region, state, ecosystem and habitat without direct or indirect human actions. [iowanativeplants.org/links.php](http://iowanativeplants.org/links.php) and [secure.iowadot.gov/lrtf/NativePlantPublic.aspx](http://secure.iowadot.gov/lrtf/NativePlantPublic.aspx)

**Naturescaping:** A method of landscaping that reduces water use, energy consumption and chemical needs by using climate-appropriate plants and maintenance techniques.

**Non-buildable land:** Land that is not economically feasible to be developed, such as easements, utility fall zones, unsuitable soil, steep grades, water features, wetlands or natural preserves.

**Open space:** Undeveloped land that is permanently set aside for public use. Open space may be used as community open space or preserved as green space, and includes parcels in conservation easement or land trust, park or recreation areas, and community gardens.

**Permeable paving:** A porous cover system that encourages groundwater recharge and infiltration. [www.rainscapingiowa.org/documents/filelibrary/permeable\\_pavement\\_systems/PermPavemtBrochure\\_1CDC21254C1A6.pdf](http://www.rainscapingiowa.org/documents/filelibrary/permeable_pavement_systems/PermPavemtBrochure_1CDC21254C1A6.pdf) and [www.iowadnr.gov/Environmental-Protection/Water-Quality/NPDES-Storm-Water/Storm-Water-Manual](http://www.iowadnr.gov/Environmental-Protection/Water-Quality/NPDES-Storm-Water/Storm-Water-Manual)

**Phenol-formaldehyde:** A resin used in the manufacture of composite wood products primarily for outdoor use, including softwood plywood and flake or oriented strand board. Composite wood products that contain phenol-formaldehyde generally emit formaldehyde at lower rates than those containing urea formaldehyde resin. [www.epa.gov/iaq/formaldehyde.html](http://www.epa.gov/iaq/formaldehyde.html)

**Photocell:** A light-sensitive device that detects ambient light and controls exterior fixtures accordingly.

**Photovoltaics:** Composite materials that convert sunlight directly into electrical power.

**Post-consumer waste:** Materials or finished products that have served their intended use and so have been diverted or recovered from waste destined for disposal.

**Post-industrial waste (also called pre-consumer waste):** Materials generated in manufacturing and converting processes such as manufacturing scrap and trimmings and cuttings.

**Public-private regional transportation:** Private company offering public transit services through a public funding stream, based on a regular schedule and permanent stops.

**Radon:** A colorless, odorless and tasteless gas that greatly affects indoor air quality. According to the EPA, radon exposure is the second leading cause of lung cancer in the United States. [idph.iowa.gov/radon](http://idph.iowa.gov/radon)

**Recessed light fixture (recessed can):** A luminaire that is installed into an opening in the ceiling or wall.

**Resilience:** The capacity to adapt to changing conditions and to maintain or regain functionality and vitality in the face of stress or disturbance. Relative to climate change, resilience involves adaptation to the wide range of regional and localized impacts that are expected with a warming planet: more intense storms, greater precipitation, coastal and valley flooding, longer and more severe droughts in some areas, wildfires, melting permafrost, warmer temperatures, and power outages. [www.resilientdesign.org](http://www.resilientdesign.org)

**Resilient flooring:** Flooring products in which the wearing surface is non-textile, including but not limited to rubber, polymeric and linoleum. [www.nsf.org/services/by-industry/sustainability-environment/sustainability-standards-protocols/floor-coverings](http://www.nsf.org/services/by-industry/sustainability-environment/sustainability-standards-protocols/floor-coverings)





**RESNET (Residential Energy Services Network):** A national not-for-profit membership corporation that is a recognized standards-making body for building energy-efficiency rating and certification systems in the United States. [www.resnet.us](http://www.resnet.us)

**Retention basin:** A shallow impoundment, sometimes referred to as a “wet detention pond,” designed to capture and retain stormwater runoff during storm events.  
[www.iowadnr.gov/Environmental-Protection/Water-Quality/NPDES-Storm-Water/Storm-Water-Manual](http://www.iowadnr.gov/Environmental-Protection/Water-Quality/NPDES-Storm-Water/Storm-Water-Manual)

**Road section:** The cross-section through a street, with particular attention paid to the width of the street and its hydrology. Carefully planned road sections can decrease the amount of impervious surfaces and improve the overall stormwater management for the project site. More information can be found in the document “Low-Impact Development Design Strategies: An Integrated Design Approach,” found at [www.lid-stormwater.net](http://www.lid-stormwater.net)

**Rock filter (or filter berm):** A permanent or temporary stone structure installed to serve as a sediment-filtering device in drainage ways. Allows a pool to form in an excavated or natural depression, where sediment can settle. The pool is then dewatered through the gravel rock dam.  
[www.epa.gov/large-scale-residential-demolition/managing-stormwater-and-dust-demolition-sites](http://www.epa.gov/large-scale-residential-demolition/managing-stormwater-and-dust-demolition-sites)

**Silt fencing:** A temporary fabric barrier surrounding a site to control stormwater runoff.  
[www.epa.gov/large-scale-residential-demolition/managing-stormwater-and-dust-demolition-sites](http://www.epa.gov/large-scale-residential-demolition/managing-stormwater-and-dust-demolition-sites)

**Silt sacks:** Tube-shaped erosion-control devices.  
[www.epa.gov/large-scale-residential-demolition/managing-stormwater-and-dust-demolition-sites](http://www.epa.gov/large-scale-residential-demolition/managing-stormwater-and-dust-demolition-sites)

**Solar hot water system:** Captures, converts and transfers heat from direct and indirect sunlight to heat an auxiliary water tank and provide hot water for a building’s occupants.

**Solar reflectance (or albedo):** A measure of a material’s ability to reflect sunlight (including the visible, infrared and ultraviolet wavelengths) on a scale of 0 to 1. A solar reflectance value of 0.0 indicates that the surface absorbs all solar radiation, and a 1.0 solar reflectance value represents total reflectivity.

**Solar south:** A measurement of the sun’s true position based on its path across the sky. It is different from magnetic south, which is taken from a compass reading. Methods for calculating solar south include the solar noon method or a compass using a magnetic declination chart to correct for magnetic declination.

**Static service pressure:** The pipeline or municipal water supply pressure when water is not flowing.

**Straw bale:** A bound block of straw and organic material used to control stormwater runoff.  
[www.epa.gov/large-scale-residential-demolition/managing-stormwater-and-dust-demolition-sites](http://www.epa.gov/large-scale-residential-demolition/managing-stormwater-and-dust-demolition-sites)

**Substantial rehabilitation:** A project that includes the replacement and/or improvement of at least two major systems of the building, including its envelope. Major building systems include roof structures, wall or floor structures, foundations, plumbing, heating and air conditioning, and electrical systems. The building envelope is defined as the air barrier and thermal barrier separating exterior from interior space.

**Supportive housing dwelling units:** Permanent housing with attached intensive services targeted to populations that have special needs, including people who are currently or formerly homeless; those with serious, chronic mental health issues; people in various stages of recovery from substance abuse; people with HIV/AIDS, or physical or developmental disabilities; the formerly incarcerated, the frail elderly, homeless or emancipated youth, and victims of domestic violence; and other groups that would not be able to live independently and maintain housing without intensive support.



**Swales:** Shallow grass-covered hydraulic conveyance channels that help to slow runoff and facilitate infiltration. [www.iowadnr.gov/Environmental-Protection/Water-Quality/NPDES-Storm-Water/Storm-Water-Manual](http://www.iowadnr.gov/Environmental-Protection/Water-Quality/NPDES-Storm-Water/Storm-Water-Manual)

**Tiers:** Earthen embankments that reduce erosion by slowing, collecting and redistributing surface runoff to stable outlets that increase the distance of overland runoff flow.

**Transit ride:** A scheduled stop along a defined route of one form of public transportation (bus, rail or ferry).

**Universal Design:** The design of products and environments to be usable by all people, to the greatest extent possible, without the need for adaptation or specialized design. The principles of Universal Design are as follows: 1) equitable use, 2) flexibility in use, 3) simple and intuitive use, 4) perceptible information, 5) tolerance for error, 6) low physical effort and 7) size and space for approach and use.

[www.ncsu.edu/ncsu/design/cud/about\\_ud/udprinciplestext.htm](http://www.ncsu.edu/ncsu/design/cud/about_ud/udprinciplestext.htm)

**Urea-formaldehyde:** A toxic resin created from formaldehyde that causes similar side effects. Composite wood products made for indoor use, such as particleboard, hardwood plywood paneling and medium-density fiberboard, often contain this resin. [www.epa.gov/formaldehyde](http://www.epa.gov/formaldehyde)

**Vapor retarder:** The International Residential Code (IRC) defines vapor retarders as Class I, II or III based on how permeable they are to water vapor — the lower the permeability, the less water vapor that will pass through the vapor retarder.

*Class I:* Very low permeability vapor retarders — rated at 0.1 perms or less. Sheet polyethylene (visqueen) or unperforated aluminum foil (FSK) are Class I vapor retarders.

*Class II:* Low permeability vapor retarders — rated greater than 0.1 perms and less than or equal to 1.0 perms. The kraft facing on batts qualifies as a Class II vapor retarder.

*Class III:* Medium permeability vapor retarders — rated greater than 1.0 perms and less than or equal to 10 perms. Latex and enamel paint qualify as Class III vapor retarders.

For additional information, visit NAIMA at:

[www.naima.org/insulation-knowledge-base/residential-home-insulation/insulation-and-vapor-retarders.html](http://www.naima.org/insulation-knowledge-base/residential-home-insulation/insulation-and-vapor-retarders.html)

**Vehicle share program:** A private system in which a company or a group of individuals share vehicles on a reservation basis and pay for the use on the basis of time or mileage. Programs that qualify under Criterion 2.7 Access to Public Transportation must have an established formal agreement among participants.

**Ventilation:** The process of supplying outdoor air to, or removing air from, a dwelling by natural or mechanical means. Such air may or may not have been conditioned.

**VOCs (volatile organic compounds):** A large group of carbon-based chemicals that easily evaporate at room temperature. [www.epa.gov/indoor-air-quality-iaq/technical-overview-volatile-organic-compounds](http://www.epa.gov/indoor-air-quality-iaq/technical-overview-volatile-organic-compounds)

**Walk distance:** The distance a pedestrian must travel between origins and destinations without obstruction, in a safe and comfortable environment on a continuous network of sidewalks, all-weather-surface footpaths, crosswalks or equivalent pedestrian facilities. Any crossing of a street with speeds at or greater than 30 miles per hour requires controlled crossing (e.g., a stop sign or stop light).

**Water factor:** The quotient of the total weighted per-cycle water consumption divided by the capacity of the clothes washer. Lower numbers indicate more efficient use of water.



---

**Watershed:** The area of land where all of the water that is under it or drains off of it goes into the same place. [www.epa.gov/hwp/basic-information-and-answers-frequent-questions](http://www.epa.gov/hwp/basic-information-and-answers-frequent-questions)

**Weather-based irrigation controller (WBIC):** An automated “thermostat for your sprinkler system” that operates your irrigation system based on local weather, landscape conditions and plant watering needs.

Weekend ride options: A public transit option of either bus, rail or ferry service. Employer-assisted vanpools and dial-a-ride programs are examples of qualifying weekend service.

**Well-being:** Well-being includes the presence of positive emotions and moods (e.g., contentment, happiness), the absence of negative emotions (e.g., depression, anxiety), satisfaction with life, fulfillment and positive functioning. In simple terms, well-being can be described as judging life positively and feeling good.

**Xeriscaping:** A method of landscaping aimed at reducing or eliminating excess water from irrigation by using drought-tolerant plants. [www.landscapingnetwork.com/landscape-design/Xeriscape.html](http://www.landscapingnetwork.com/landscape-design/Xeriscape.html)



Iowa Economic Development Authority

1963 Bell Avenue, Suite 200

Des Moines, Iowa 50315

515.348.6200

[iowaeda.com](http://iowaeda.com)